

TASCAM

TEAC Professional Division

D00637200A

MF-P01

PORTASTUDIO

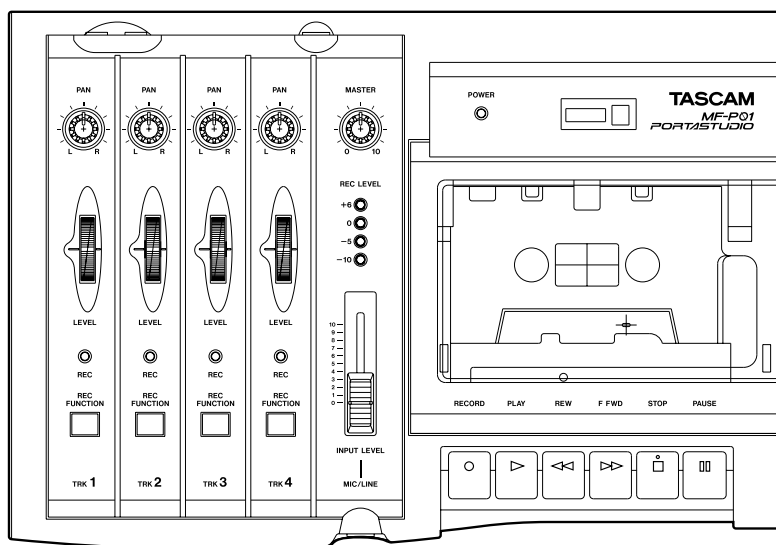

OWNER'S MANUAL



CAUTION
RISK OF ELECTRIC SHOCK
DO NOT OPEN



CAUTION: TO REDUCE THE RISK OF ELECTRIC SHOCK, DO NOT REMOVE COVER (OR BACK). NO USER-SERVICEABLE PARTS INSIDE. REFER SERVICING TO QUALIFIED SERVICE PERSONNEL.



The lightning flash with arrowhead symbol, within an equilateral triangle, is intended to alert the user to the presence of uninsulated "dangerous voltage" within the product's enclosure that may be of sufficient magnitude to constitute a risk of electric shock to persons.



The exclamation point within an equilateral triangle is intended to alert the user to the presence of important operating and maintenance (servicing) instructions in the literature accompanying the appliance.

This appliance has a serial number located on the rear panel. Please record the model number and serial number and retain them for your records.
Model number _____

WARNING: TO PREVENT FIRE OR SHOCK HAZARD, DO NOT EXPOSE THIS APPLIANCE TO RAIN OR MOISTURE.

IMPORTANT (for U.K. Customers)

DO NOT cut off the mains plug from this equipment.

If the plug fitted is not suitable for the power points in your home or the cable is too short to reach a power point, then obtain an appropriate safety approved extension lead or consult your dealer.

If nonetheless the mains plug is cut off, remove the fuse and dispose of the plug immediately, to avoid a possible shock hazard by inadvertent connection to the mains supply.

If this product is not provided with a mains plug, or one has to be fitted, then follow the instructions given below:

IMPORTANT. DO NOT make any connection to the larger terminal which is marked with the letter E or by the safety earth symbol \perp or coloured GREEN or GREEN-and-YELLOW.

The wires in the mains lead on this product are coloured in accordance with the following code:

BLUE: **NEUTRAL**
BROWN: **LIVE**

As these colours may not correspond with the coloured markings identifying the terminals in your plug proceed as follows:

The wire which is coloured BLUE must be connected to the terminal which is marked with the letter N or coloured BLACK.

The wire which is coloured BROWN must be connected to the terminal which is marked with the letter L or coloured RED.

When replacing the fuse only a correctly rated approved type should be used and be sure to re-fit the fuse cover.

IF IN DOUBT — CONSULT A COMPETENT ELECTRICIAN.

Important Safety Instructions	2
An introduction to the MF-P01	4
Multitrack recording - a brief introduction.....	4
Some safety notes and precautions	4
What you need to make recordings	6
Connecting the MF-P01.....	6
Parts of the MF-P01	7
Recording tracks	10
Setting up	10
Setting the level	10
Recording the first track	11
Recording the next track (overdubbing)	11
Mixing down tracks.....	12
Setting up	12
Mixdown	13
Hints and advanced tips	13
Recording techniques	13
Recording electric guitars	13
Recording with effects.....	14
When you're not recording	14
Recording more than four tracks.....	14
Troubleshooting	15
Specifications	15

IMPORTANT SAFETY INSTRUCTIONS

CAUTION:

- Read all of these Instructions.
- Save these Instructions for later use.
- Follow all Warnings and Instructions marked on the audio equipment.

- 1) Read Instructions** — All the safety and operating instructions should be read before the product is operated.
- 2) Retain Instructions** — The safety and operating instructions should be retained for future reference.
- 3) Heed Warnings** — All warnings on the product and in the operating instructions should be adhered to.
- 4) Follow Instructions** — All operating and use instructions should be followed.
- 5) Cleaning** — Unplug this product from the wall outlet before cleaning. Do not use liquid cleaners or aerosol cleaners. Use a damp cloth for cleaning.
- 6) Attachments** — Do not use attachments not recommended by the product manufacturer as they may cause hazards.
- 7) Water and Moisture** — Do not use this product near water — for example, near a bath tub, wash bowl, kitchen sink, or laundry tub; in a wet basement; or near a swimming pool; and the like.
- 8) Accessories** — Do not place this product on an unstable cart, stand, tripod, bracket, or table. The product may fall, causing serious injury to a child or adult, and serious damage to the product. Use only with a cart, stand, tripod, bracket, or table recommended by the manufacturer, or sold with the product. Any mounting of the product should follow the manufacturer's instructions, and should use a mounting accessory recommended by the manufacturer.
- 9) A product and cart combination** should be moved with care. Quick stops, excessive force, and uneven surfaces may cause the product and cart combination to overturn.



- 10) Ventilation** — Slots and openings in the cabinet are provided for ventilation and to ensure reliable operation of the product and to protect it from overheating, and these openings must not be blocked or covered. The openings should never be blocked by placing the product on a bed, sofa, rug, or other similar surface. This product should not be placed in a built-in installation such as a bookcase or rack unless proper ventilation is provided or the manufacturer's instructions have been adhered to.
- 11) Power Sources** — This product should be operated only from the type of power source indicated on the marking label. If you are not sure of the type of power supply to your home, consult your product dealer or local power company. For products intended to operate from battery power, or other sources, refer to the operating instructions.
- 12) Grounding or Polarization** — This product may be equipped with a polarized alternating-current line plug (a plug having one blade wider than the other). This plug will fit into the power outlet only one way. This is a safety feature. If you are unable to insert the plug fully into the outlet, try reversing the plug. If the plug should still fail to fit, contact your electrician to replace your obsolete outlet. Do not defeat the safety purpose of the polarized plug.
- 13) Power-Cord Protection** — Power-supply cords should be routed so that they are not likely to be walked on or pinched by items placed upon or against them, paying particular attention to cords at plugs, convenience receptacles, and the point where they exit from the product.
- 14) Outdoor Antenna Grounding** — If an outside antenna or cable system is connected to the product, be sure the antenna or cable system is grounded so as to provide some protection against voltage surges and built-up static charges. Article 810 of the National Electrical Code, ANSI/NFPA 70, provides information with regard to proper grounding of the mast and supporting structure, grounding of the lead-in wire to an antenna-discharge unit, size of grounding conductors, location of antenna-discharge unit, connection to grounding electrodes, and requirements for the grounding electrode.

"Note to CATV system installer:

This reminder is provided to call the CATV system installer's attention to Section 820-40 of the NEC which provides guidelines for proper grounding and, in particular, specifies that the cable ground shall be connected to the grounding system of the building, as close to the point of cable entry as practical.

Example of Antenna Grounding as per National Electrical Code, ANSI/NFPA 70

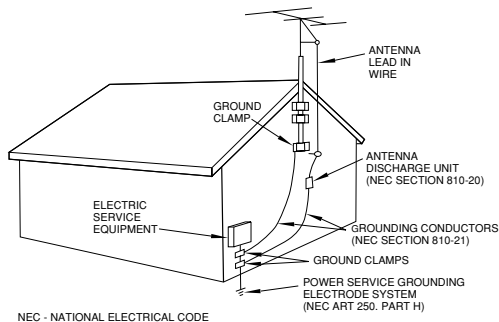

- 15) Lightning** — For added protection for this product during a lightning storm, or when it is left unattended and unused for long periods of time, unplug it from the wall outlet and disconnect the antenna or cable system. This will prevent damage to the product due to lightning and power-line surges.
- 16) Power Lines** — An outside antenna system should not be located in the vicinity of overhead power lines or other electric light or power circuits, or where it can fall into such power lines or circuits. When installing an outside antenna system, extreme care should be taken to keep from touching such power lines or circuits as contact with them might be fatal.
- 17) Overloading** — Do not overload wall outlets, extension cords, or integral convenience receptacles as this can result in risk of fire or electric shock.
- 18) Object and Liquid Entry** — Never push objects of any kind into this product through openings as they may touch dangerous voltage points or short-out parts that could result in a fire or electric shock. Never spill liquid of any kind on the product.
- 19) Servicing** — Do not attempt to service this product yourself as opening or removing covers may expose you to dangerous voltage or other hazards. Refer all servicing to qualified service personnel.
- 20) Damage Requiring Service** — Unplug this product from the wall outlet and refer servicing to qualified service personnel under the following conditions:
 - a) when the power-supply cord or plug is damaged.
 - b) if liquid has been spilled, or objects have fallen into the product.
 - c) if the product has been exposed to rain or water.
 - d) if the product does not operate normally by following the operating instructions. Adjust only those controls that are covered by the operating instructions as an improper adjustment of other controls may result in damage and will often require extensive work by a qualified technician to restore the product to its normal operation.
 - e) if the product has been dropped or damaged in any way.
 - f) when the product exhibits a distinct change in performance — this indicates a need for service.
- 21) Replacement Parts** — When replacement parts are required, be sure the service technician has used replacement parts specified by the manufacturer or have the same characteristics as the original part. Unauthorized substitutions may result in fire, electric shock, or other hazards.
- 22) Safety Check** — Upon completion of any service or repairs to this product, ask the service technician to perform safety checks to determine that the product is in proper operating condition.
- 23) Wall or Ceiling Mounting** — The product should be mounted to a wall or ceiling only as recommended by the manufacturer.
- 24) Heat** — The product should be situated away from heat sources such as radiators, heat registers, stoves, or other products (including amplifiers) that produce heat.

An introduction to the MF-P01

The TASCAM MF-P01 PORTASTUDIO allows you to perform multitrack recordings which are not possible with an ordinary stereo cassette recorder.

Multitrack recording - a brief introduction

This section gives you a brief introduction to some of the terms and techniques used in recording. If you are unfamiliar with these terms, you may find it useful to read through this section so that you understand the rest of the manual, which uses the terms explained here.

Multitrack recorders

The MF-P01 allows you to record up to 4 tracks on Type II (chrome) cassette tapes. It accepts an input and feeds it into a recorder which can record tracks independently of each other, and builds up the song by recording new tracks while listening to what has been recorded before ("overdubbing").

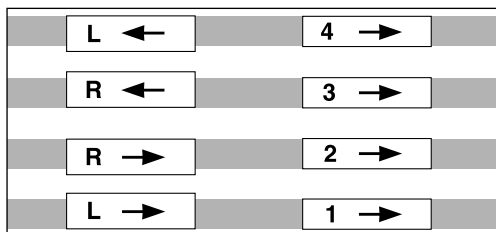

Ordinary cassette MF-P01

The illustration below shows you how tracks are arranged on an ordinary stereo cassette tape, as well as on the MF-P01.

Notice that the stereo cassette arrangement allows you to use both sides of the cassette, by playing the tape in the other direction. The MF-P01, however, uses the whole width of the tape. Notice also that one pair of L and R tracks on the stereo cassette take up the same positions as tracks 1 and 2 on the MF-P01. This allows the MF-P01 to play back normal cassette tapes using tracks 1 and 2.

Mixing down

When you come to make the final version (on MD, cassette, etc.), you can adjust the level (volume) and the stereo position (panning) of each track.

The technique of converting a multitrack recording to a stereo recording is called "mixing down" to a "stereo master" recorder. The MF-P01 includes a mixdown section which allows you to mix to a stereo cassette or MD recorder.

Some safety notes and precautions

- Always use the PS-P2 power adaptor supplied with the MF-P01. If you use any other adaptor, there is a risk of damage, or even fire. Make sure that the input voltage marked on the PS-P2 adaptor matches the power supply you are using. If you are in any doubt, consult your TASCAM dealer.
- Turn off your MF-P01 and remove the cassette when you are not using the MF-P01. If you will not be using it for an extended period of time, unplug the PS-P2 adaptor.
- When connecting or disconnecting the MF-P01 to or from any other equipment, make sure the power to the MF-P01 and all other equipment is turned off. This will avoid possible damage to equipment.
- Do not keep your MF-P01 in a very hot place. Remember that in sunny weather, the inside of a parked car heats up very quickly. Avoid leaving your MF-P01 in such a place.
- Do not spill liquid onto your MF-P01. Avoid eating, drinking and smoking near it (smoke particles are bad for audio equipment). If any liquid or any objects such as paperclips, guitar picks, etc. fall inside the MF-P01, do not try to operate it. Return it to a TASCAM service center for repair.
- If the case of the MF-P01 becomes dirty, clean it only with a damp (not wet) cloth, moistened with a little detergent. Do not use solvents or thinners, etc. to clean the MF-P01, as these will damage the surface.
- There are no parts inside the MF-P01 that you can repair by yourself. Do not open the MF-P01 case or try to make any repairs. Return it to a TASCAM service center for repair.

Tape cassettes

- Since the MF-P01 uses the whole width of a cassette tape, you can use only one side of a cassette for playing and recording. You should try to use either side A or side B for all cassettes, to avoid confusion when changing tapes.
- Only use Type II (chrome or high position) cassettes with the MF-P01.
- Remember that because you are only using one side of the cassette, the marked length of the tape will be halved (that is, a C60 tape will run for 30 minutes, a C40 for 20 minutes, etc.).
- Always store cassettes in a safe place (away from the magnetic fields produced by speakers, television sets, computer monitors, etc.).

Record-protecting cassettes

The record-protect tab on a cassette stops you recording on that side when it is removed.

The MF-P01 also recognizes this protection, and will not allow you to record on the side of a cassette where this tab has been removed.

However, we suggest that you remove both tabs when you want to protect a MF-P01 cassette. This will stop you putting in the cassette the wrong way round and recording over old material accidentally.

Playing back stereo cassettes

As mentioned earlier, the MF-P01 can play back cassettes recorded on a stereo cassette recorder, using tracks 1 and 2.

Also, if tracks 1 and 2 have been recorded on the MF-P01, these cassettes can be played back on a stereo cassette recorder.

However, if tracks 3 and 4 are used for recording on the MF-P01, these cannot be played back on a stereo cassette recorder.

Also, note that if a cassette has been recorded with noise reduction, such as Dolby, etc., it will sound strange when played back on the MF-P01. Any tapes (tracks 1 and 2) recorded on the MF-P01 should be played back without noise reduction on a stereo recorder.

"Dolby" is a registered trademark of Dolby Laboratories Licensing Corporation.

NOTE

Never use C120 cassettes with the MF-P01. The tape in these cassettes is thin, and may stretch and break.

Cleaning the heads

You should clean the tape heads of the MF-P01 regularly to keep it working properly. Dirt and tape oxide buildup on the heads will force the tape away from the tape head gaps that record and playback. Head cleaner will remove the dirt and restore the sound quality.

In addition to affecting performance by coating the heads, and keeping the tape away from the recording and playback gaps, dirt and oxide in the tape path will also act in the same way as very fine sandpaper, which will wear down internal parts of the MF-P01, and affect the recording in this way as well.

All of these problems can be avoided if you buy a head cleaning kit such as the TEAC TZ-261 and keep it with your MF-P01 for regular use. The kit consists of head cleaner, cleaner for the rubber parts of the MF-P01, and cotton-tipped swabs.

WARNING

Only use head and rubber cleaning fluid and cleaning swabs designed for use with tape recorders. The use of any other cleaning materials may cause damage to the MF-P01.

Clean the heads and metal parts of the tape path before every session with the MF-P01 and also after every session.

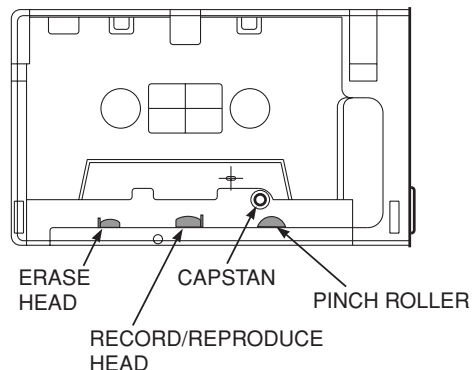

- 1) **Open the tape cassette cover.**
- 2) **Carefully clean the heads and metal parts as shown in the illustration using a swab dipped in the head cleaning fluid.**
- 3) **Dry off the heads with a dry swab.**

Cleaning the pinch roller

You should also clean the rubber pinch roller at regular intervals (at least once each day that you use the MF-P01).

- 1) **Open the tape cassette cover.**
- 2) **Press the PLAY key.**
The pinch roller will engage with the capstan shaft and start turning.
- 3) **Press a swab dipped in the rubber cleaning fluid against the right side of the pinch roller.**
If you press the right side of the roller, the swab will not get caught between the roller and capstan.
- 4) **Dry the capstan with a dry swab and make sure that there is no material on the pinch roller or capstan before you insert a cassette.**

What you need to make recordings

Apart from the MF-P01 itself, you will need:

- Some kind of stereo master recorder (such as a cassette or MD recorder) to produce the stereo recordings.
- You will also need RCA (pin or phono) cables to connect the MF-P01 to other equipment.
- Some monitoring equipment (some kind of amplifier and speaker system).
- Headphones, if you intend doing any work with microphones. These will avoid acoustic feedback ("howl-round") when recording. Additionally, headphones are sometimes useful when panning tracks on mixdown, as you can hear the precise position of each track.
- Of course, you will also need some kind of sound source to record (instrument or microphone, etc.).

Connecting the MF-P01

- 1) Make sure all the equipment is turned off.
- 2) Connect the **LINE OUT** terminals of the MF-P01 to the amplifier, using a pair of terminals on the amplifier such as **AUX**, **TUNER** or **TAPE**.

NOTE

Do not use any terminals marked **PHONO** or intended for record players (turntables). These are connected to a special circuit inside the amplifier which makes them unsuitable for anything except record players.

- 3) Connect your master recorder to a set of four **TAPE** terminals on the amplifier (two for **REC** and two for **PLAY**).

You can listen to the MF-P01 by selecting the amplifier's input source to be the terminals to which you connected the MF-P01.

When you have mixed down and you want to listen to the mixed tape, you should select the master recorder as the amplifier's input source.

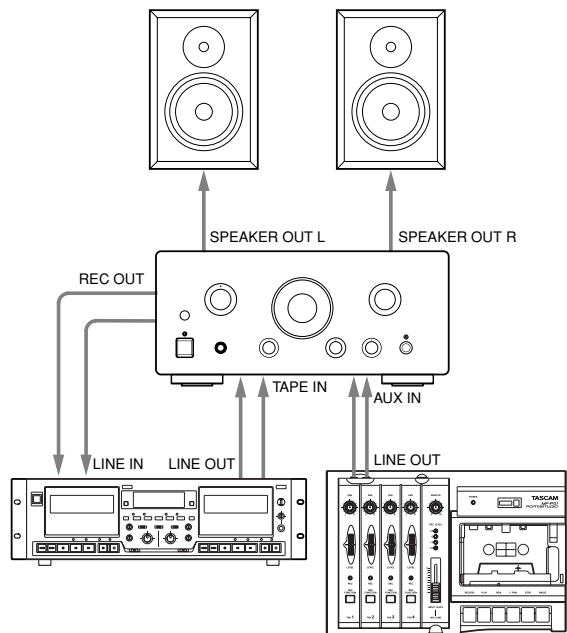

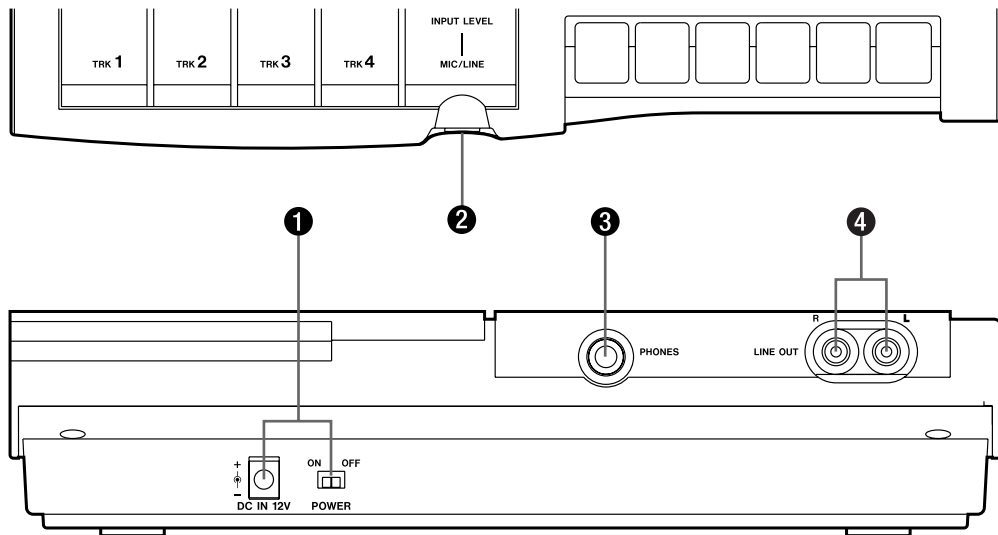

❶ DC IN 12 V connector and POWER switch

Use this jack to connect the PS-P2 AC adaptor which comes with your MF-P01.

When connecting the power, make sure the power switch is off (slide it to the right, as you look from the back).

Slide the switch to the left (looking from the back) to turn on the power to the MF-P01.

WARNING

DO NOT use any adaptor with the MF-P01 except the PS-P2 adaptor which comes with the MF-P01.

NOTE

The equipment draws nominal non-operating power from the AC outlet with its POWER switch in the off position.

❷ MIC/LINE jack

Use this 1/4" phone jack to connect an audio source (instrument or microphone) to the MF-P01.

The source signal is sent to a recording track, as well as fed from the LINE OUT (L, R) and PHONES jacks.

❸ PHONES jack

Use this 1/4" jack to connect a pair of stereo headphones to monitor tape playback or/and MIC/LINE input signals.

CAUTION

- When using the LINE OUT jacks, to obtain better audio performance, unplug headphones.

WARNING

- Do not use headphones equipped with a mono jack. This will cause damage to the MF-P01's headphone amplifiers.

❹ LINE OUT jacks

Use these RCA (pin or phono) jacks to connect your MF-P01 to the amplifier or master recorder.

Tape playback or/and MIC/LINE input signals are output from these jacks.

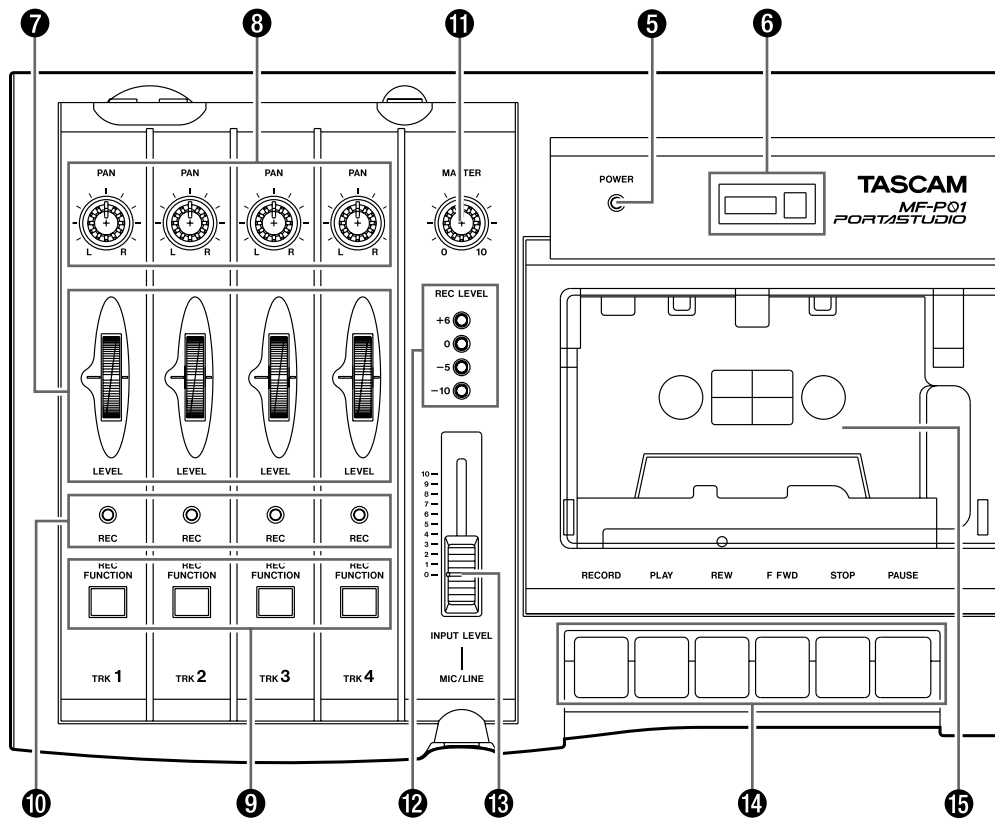

5 POWER indicator

This indicator is lit when the MF-P01 is connected to the power supply and switched on.

6 Tape counter and reset button

The tape counter allows you to note different parts of the tape and locate to them. Pressing the RESET button resets the counter to "000".

7 LEVEL controls (for TRK1 through TRK4)

These controls change the levels of the four tape tracks in the LINE OUT and PHONES outputs.

8 PAN controls (for TRK1 through TRK4)

These controls change the position of the four tape tracks in the stereo LINE OUT and PHONES outputs. When one of these controls is turned fully counter-clockwise, the sound of the corresponding tape track will appear to come from the left, and when turned fully clockwise, it will appear to come from the right. When in the center position, the output will appear equally from both the left and right.

9 REC FUNCTION switches (for TRK1 through TRK4)

When recording the signal coming into the MIC/LINE jack to one of the four tracks, press down the appropriate REC FUNCTION switch to make the track ready to be recorded.

To release the "record-ready" track (to make all tracks "record-off"), press one of the other REC FUNCTION switches lightly.

To change the "record-ready" track, press down the REC FUNCTION switch for the desired track. The current "record-ready" track will be automatically released.

WARNING

Do not make more than one track "record-ready", though you can press down more than one REC FUNCTION switch simultaneously by using more than one finger.

10 REC indicators (for TRK1 through TRK4)

When one of the tracks is ready for recording, the appropriate REC indicator flashes.

When one of the tracks is being recorded, the appropriate REC indicator lights steadily.

11 MASTER control

This control adjusts the master level of the signals which are sent to LINE OUT (L, R) jacks, as well as the PHONES jack.

12 REC LEVEL indicators (+6, 0, -5, -10)

A set of four LED indicators shows the level of the MIC/LINE signal sent to the recording track.

See "Setting the level" on page 10 for details about level setting.

13 INPUT LEVEL fader

This fader is used to adjust the level of the signal coming into the MIC/LINE jack.

14 Transport controls

- **RECORD button :** Starts recording of the track whose REC indicator is illuminated. Note that pressing this button also presses down the PLAY button.

NOTE

When no REC indicator is lit, pressing down the RECORD button does not start recording but start playback.

- **PLAY button :** Starts playback.
- **REW button :** Rewinds the tape.
- **F FWD button :** Fast-forwards the tape.
- **STOP button :** Stops the tape.
- **PAUSE button :** Pauses recording or playback.

NOTES

- If the left record-protect tab of the cassette has been broken out, or if there is no cassette loaded, the RECORD button cannot be pressed.
- It is not possible to go directly from recording into playback mode.
- The PAUSE button only pauses playback and recording. It is not possible to pause the tape in fast forward and rewind modes.
- All buttons except the STOP button lock down when pressed, and only work when locked down.

15 Cassette compartment cover

The hinged cassette compartment cover is opened by lifting the tab on the right side.

The tape should be towards the front of the MF-P01. Put the non-tape part of the cassette in first, and then push the tape (front) down into place.

Recording tracks

This section describes how to make a 4-track recording using the MF-P01. For this, we will assume that you are making a recording of your guitar on track 1 using a microphone first, and then recording your voice on track 2 while monitoring track 1

Setting up

- 1) Make sure the MF-P01 is turned off.
- 2) Plug the stereo headphones into the PHONES jack.

NOTE

Use headphones for monitoring while recording a microphone source. Never use loudspeakers for monitoring a microphone source which may cause feedback. You can use loudspeakers for monitoring while recording a line source (such as a synthesizer).

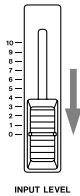

INPUT LEVEL



POWER

- 3) With the INPUT LEVEL fader at the lowest position, plug the microphone into the MIC/LINE jack.

- 4) Set the POWER switch to "ON" to turn on the MF-P01.

- 5) Insert a Type II (high position) cassette tape.

Make sure that the full spool is on the left side (the tape is fully rewound to the beginning).

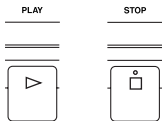

- 6) Press the PLAY button to play the tape, and then press the STOP button after about 10 seconds to stop the tape.



- 7) Press the counter reset button to reset the counter to "000".

Setting the level

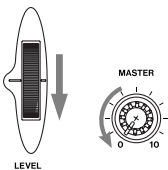

This section describes how to set the input level so that the average signals coming from the MIC/LINE input will light the 0 meter indicator, and the loudest will light the +6 indicator.

- 1) Set all LEVEL and MASTER controls to "0" (minimum).

- 2) Adjust the recording level using the INPUT LEVEL fader, while playing the guitar to the microphone.

The INPUT LEVEL fader should be set to the position where the +6 indicator is lit on the loudest parts of the guitar.

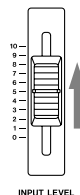

INPUT LEVEL



MASTER

- 3) Using the MASTER control, adjust the headphones monitor level until you are comfortable with what you hear in the headphones.

NOTE

You do not have to monitor the sound during the first track recording.

Recording the first track



- 1) Press the **REC FUNCTION** key for track 1 so that the **REC** indicator flashes. You are now ready to record on track 1.



- 2) Press down the **RECORD** button to start recording the first guitar track. The REC indicator for track 1 lights steadily.



- 3) When you have finished, press the **STOP** button. The tape stops.



- 4) Press the **REW** button. The tape is rewound to the "000" position (where you started recording).



- 5) Press the **PLAY** button to check your recording. Adjust the **LEVEL** control of track 1 so that you can hear clearly what you have just recorded. You can use the **PAN** control to set the stereo positioning if required.

If you are not satisfied with your recording, try again.

- 6) When you're happy with the recording, go to the second track recording described below.

Recording the next track (overdubbing)

The next step is to record your vocal to track 2 while listening to the playback sound of your guitar on track 1.



- 1) Press the **REW** button to rewind the tape to "000".

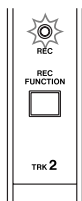

- 2) Press the **REC FUNCTION** switch for track 2 to set track 2 to "record ready". The REC indicator for track 2 starts flashing, while the REC indicator for track 1 turns off.



- 3) Press the **PLAY** button to playback the tape, and sing into the microphone while monitoring the guitar sound. You can monitor both the guitar on track 1 and your voice via the headphones.

Recording tracks

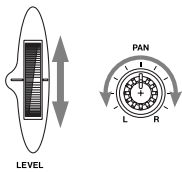

- 4) **Adjust the recording level for track 2, in the same way as shown above (see "Setting the level").**

Use the LEVEL and PAN controls for track 1 to control the track 1 sound.
Use the MASTER control to adjust the overall monitor level.

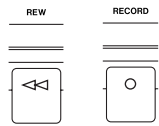

- 5) **When you are ready, press the REW button to rewind the tape and press the RECORD button to start recording.**



- 6) **Press the STOP button to stop recording.**

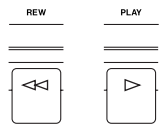

- 7) **Press the REW button to rewind and press the PLAY button to start playback. Adjust the level and pan position of the two tracks with the LEVEL and PAN controls for tracks 1 and 2.**

- 8) **If you are not satisfied with your recording, try again.**

The MF-P01 has 4 tracks. You can record two more musical tracks (another guitar part, harmony vocals, bass, etc.) to tracks 3 and 4, in the same manner described above, while monitoring the previously recorded tracks.

Mixing down tracks

After completing recording, the next (final) process is "mixdown". We assume that all the four tracks are recorded.

Setting up

- 1) **Unplug the stereo headphones.**

NOTE

When headphones are plugged in, the audio performance from the LINE OUT jacks is slightly degraded.

WARNING

Before making the connections below, make sure that all equipment is turned off.

- 2) **Connect the LINE OUT jacks of the MF-P01 to the AUX IN (or TUNER IN, CD IN, TAPE IN, etc) of your amplifier.**
- 3) **Connect the master recorder to the amplifier appropriately (see page 6).**
- 4) **Set the amplifier's input source to the MF-P01 and the level volume appropriately.**

NOTE

You may directly connect the MF-P01 LINE OUT jacks to the recorder's line input jacks without using any amplifier.

Mixdown

1) Make sure that no REC indicator is lit.

To release the "record-ready" track (to make all tracks "record-off"), press a REC FUNCTION switch whose REC indicator is not lit lightly.

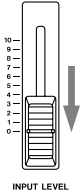

2) Set the INPUT LEVEL fader to minimum.

This will stop any extra unwanted noise from the MIC/LINE input appearing in the final mix.



3) Make sure the master recorder is ready to record, and put it into record pause mode.

4) Press the PLAY button on the MF-P01 to play back recorded tracks.

5) Adjust the LEVEL and PAN controls for each track on the MF-P01 to get the proper level balance and positioning of the sounds.

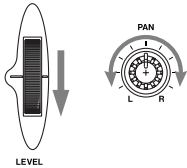

6) Adjust the recording level of the master recorder.

You can adjust it by:

- using the MASTER control of the MF-P01 to adjust the output level, or
- using the input level control of the master recorder.

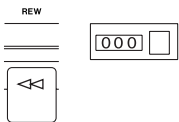

7) Press the REW button to rewind to the start of the recording ("000") on the MF-P01.

8) Start recording on the master recorder, and start playback on the MF-P01.

9) When mixdown recording is completed, stop both units.

NOTE:

There are special methods to add more sound to the mixdown sound. See "Recording more than four tracks" on page 14 for details

Hints and advanced tips

This section gives a few hints and tips which may be useful to you when you make recordings using the MF-P01.

Recording techniques

Learning how to record is an art, not a science. One of the best teachers is experience. However, there are a few things mentioned here which may be useful to you, and there are several good books on the subject which can explain the theory of recording and some of the techniques.

Recording electric guitars

Much of the sound of an electric guitar (and also bass) is due to the effects, amplifier and speakers, as well as the guitar and style of playing. If you plug the

guitar straight into the MF-P01, you will, of course, be able to record it, but the sound will probably not be what you are used to.

Plugging effects units between the guitar and the MF-P01 will certainly help to produce a fuller sound. The sound which will come closest to a live sound, though, will be provided by the amplifier itself.

You can adopt one of two approaches:

either put a microphone in front of the guitar speaker and record this, or connect the output of the pre-amplifier to the MF-P01 and record this.

WARNING

Do not connect the speaker output of the amplifier to the MF-P01. This will almost certainly damage the

Hints and advanced tips

MF-P01, and may damage the amplifier. Only use outputs which are marked LINE OUT, PRE OUT, DIRECT OUT and so on. Avoid using any outputs marked SPEAKER OUT, SP OUT, 4Ω, 8Ω, 16Ω or the like.

Recording with effects

Professional recordings often use effects like digital reverberation on vocals, etc.

You can add effects such as a reverberation by plugging a source (instrument or microphone) into an effects unit, and plugging the unit into the MF-P01. Note that the effects unit must be able to accept microphone-level signals when connecting a microphone.

In addition, you will need to use the internal balance control in the unit to decide how much of the "dry" (unaffected) sound will be passed through to the MF-P01 for recording.

If you do not have access to a reverberation unit, you can try recording vocals in a very "live" room (without many furnishings).

When you're not recording

Try to get into the habit of always leaving all the REC FUNCTION switches in the "off" state unless you are actually recording or rehearsing a take.

This will stop you recording by accident (remember that pressing RECORD with all the REC FUNCTION switches to "off" is the same as pressing PLAY).

Recording more than four tracks

Although the MF-P01 has only 4 tracks, it is possible to produce a mix with more than four sounds. There are two methods, as shown below.

Method 1:

- By playing along with the track sounds while mixdown recording, you can also mix an additional sound together with tracks 1 through 4.

In this case, the "live" sound is fed via the MIC/LINE input, so it is always positioned in the center.

- 1) Record on all four tracks of the MF-P01, and set all REC FUNCTION switches to "off".
- 2) Adjust settings of LEVEL and PAN for all tracks for mixdown.
- 3) Connect the source for the extra input to the MIC/LINE jack.
- 4) Use the INPUT LEVEL fader to adjust the levels of the input signals against the tape tracks.
- 5) Adjust the recording level of the master recorder using the MASTER control of the MF-P01 or the input level control of the master recorder.

Method 2:

For this method, there must be an ordinary stereo cassette recorder used as the master recorder.

- 1) Make mixdown recording to a TYPE II cassette tape with no noise reduction according to the procedures described in "Mixing down tracks" on page 12.
- 2) Load this mixed tape in the MF-P01.
The mixed-down signals are played back from tracks 1 and 2, and you can now record additional materials on tracks 3 and 4.

There are a few points to remember:

- Although you can repeat this process of mixing 4 tracks to 2 and then adding 2 more, as you repeat the mix process, noise and hiss will build up to a point where the quality becomes unacceptable.
- The master recorder must have its noise reduction turned off when mixing the MF-P01 tracks to the mastering machine, as the MF-P01 does not use noise reduction. Of course, on the final stereo mix, you can use noise reduction on the master recorder.
- Once you have mixed the four tracks to two, you cannot adjust their levels or pan positions again on the new tape. Think ahead to what tracks you will record on the new tape, and mix accordingly.

Tracing faults in a recording setup is often a mixture of logical deduction and patience. Very often, the problem is caused by something simple; a cable which hasn't been plugged in properly, or a faulty cable. If you discover a faulty cable, replace it with a new one - it's not worth hanging onto bad cables!

The MF-P01's POWER light does not come on.

Is the PS-P2 adaptor plugged into the power supply?
 Is the PS-P2 adaptor plugged into the MF-P01?
 Is the POWER switch on the MF-P01 set to ON?

The tape does not move when the PLAY button is pressed.

Is the tape properly inserted in the MF-P01?
 Is the tape at the end of the tape?

Some tracks have been recorded on the tape, but nothing can be heard when playing back.

If you've just put in a tape you recorded in another session, make sure that it's the right way round. Make sure the LEVEL and MASTER controls are set appropriately (not to "0").
 If you can hear something through the headphones but cannot from the speakers, check the LINE OUT connections and make sure the amplifier is set to the correct input source.

Nothing appears on the meter indicators when a source is played.

Is the source (microphone, guitar, etc.) switched on and volume control turned up? If it uses batteries, does it need new batteries?
 Is the INPUT LEVEL control of the channel set appropriately (not to "0")?

Cannot press the RECORD key.

Is the tape properly inserted in the MF-P01?
 Is the tape record-protected?

The RECORD key is pressed, the tape moves, but nothing is recorded, or the level is very low.

Is one of the REC FUNCTION switches depressed?
 Check the LEVEL control for the track.
 Is the INPUT LEVEL control set correctly?
 Is the recording level is too low or too high?

Tape sounds are muffled on playback.

The heads are dirty. Clean them (see "Cleaning the heads").

The mixdown signal is noisy or distorted.

Is the recording level is too low?
 Is the PHONES plug is connected during mixdown?

Specifications

Track format:	4 tracks, 4 channels
Head configuration:	1 x 4-track record/replay head (Permalloy) 1 x 4-track erase head (ferrite)
Motor type:	1 x DC motor (capstan and reel motor)
Tape speed:	1 7/8 in./sec (4.76 cm/sec)
Wow and flutter:	0.25%
Fast wind time:	Approx 120 seconds (C-60 tape)
Power requirements:	USA/CANADA: 120 V AC, 60 Hz U.K./EUROPE: 230 V AC, 50 Hz AUSTRALIA: 240 V AC, 50 Hz
Power consumption:	7 W, via the supplied PS-P2 AC adaptor
Physical dimensions (w x h x d):	295 x 70 x 205 (mm), 12.0 x 2.8 x 8.1 (in.),
maximum height (including controls)	81 (mm), 3.2(in)
Weight (main unit):	1.1 kg (2.4 lb)
MIC/LINE input (1/4" phone jack)	
Input level:	-50 dBV or higher
Input impedance:	50 kΩ
LINE OUT (2 x RCA jacks)	
Output level:	-10 dBV
Output impedance:	10 kΩ

Specifications

Headphone output (1/4" stereo phone jack)

Output level:	4 mW + 4 mW
Output impedance:	30 Ω
Frequency response:	50 Hz to 12.5 kHz +/-3 dB
Signal-to-noise ratio:	43 dB
Total Harmonic Distortion:	Better than 3.0%
Channel separation:	Better than 40 dB
Erasure:	65 dB (at 1 kHz)

- 0 dBV is referenced to 1 volt.
- Changes in features or specifications may be made without notice or obligation.

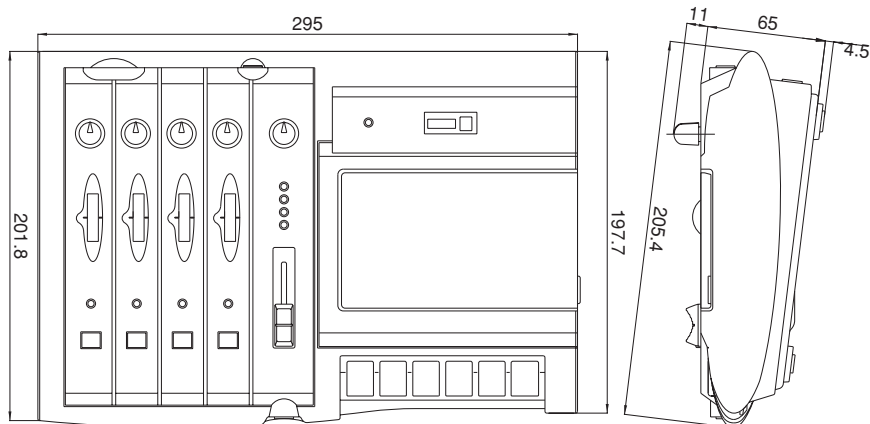

All measurements given in millimeters.

TEAC CORPORATION

Phone: (0422) 52-5082

3-7-3, Nakacho, Musashino-shi, Tokyo 180-8550, Japan

TEAC AMERICA, INC.

Phone: (323) 726-0303

7733 Telegraph Road, Montebello, California 90640

TEAC CANADA LTD.

Phone: 905-890-8008 Facsimile: 905-890-9888

5939 Wallace Street, Mississauga, Ontario L4Z 1Z8, Canada

TEAC MEXICO, S.A. De C.V

Phone: 5-658-1943

Privada De Corina, No.18, Colonia Del Carmen Coyoacan, Mexico DF 04100

TEAC UK LIMITED

Phone: 01923-819699

5 Marlin House, Marlins Meadow, The Croxley Centre, Watford, Herts. WD1 8YA, U.K.

TEAC DEUTSCHLAND GmbH

Phone: 0611-71580

Bahnstrasse 12, 65205 Wiesbaden-Erbenheim, Germany

TEAC FRANCE S. A.

Phone: 01.42.37.01.02

17 Rue Alexis-de-Tocqueville, CE 005 92182 Antony Cedex, France

TEAC BELGIUM NV/SA

Phone: 0031-30-6048115

P.A. TEAC Nederland BV, Perkinsbaan 11a, 3439 ND Nieuwegein, Netherlands

TEAC NEDERLAND BV

Phone: 030-6030229

Perkinsbaan 11a, 3439 ND Nieuwegein, Netherlands

TEAC AUSTRALIA PTY.,LTD. A.C.N. 005 408 462

Phone: (03) 9644-2442

106 Bay Street, Port Melbourne, Victoria 3207, Australia

TEAC ITALIANA S.p.A.

Phone: 02-66010500

Via C. Cantù 11, 20092 Cinisello Balsamo, Milano, Italy