

TASCAM

TEAC Professional Division

D00539600A

DA-98HR

Digital Multitrack Recorder

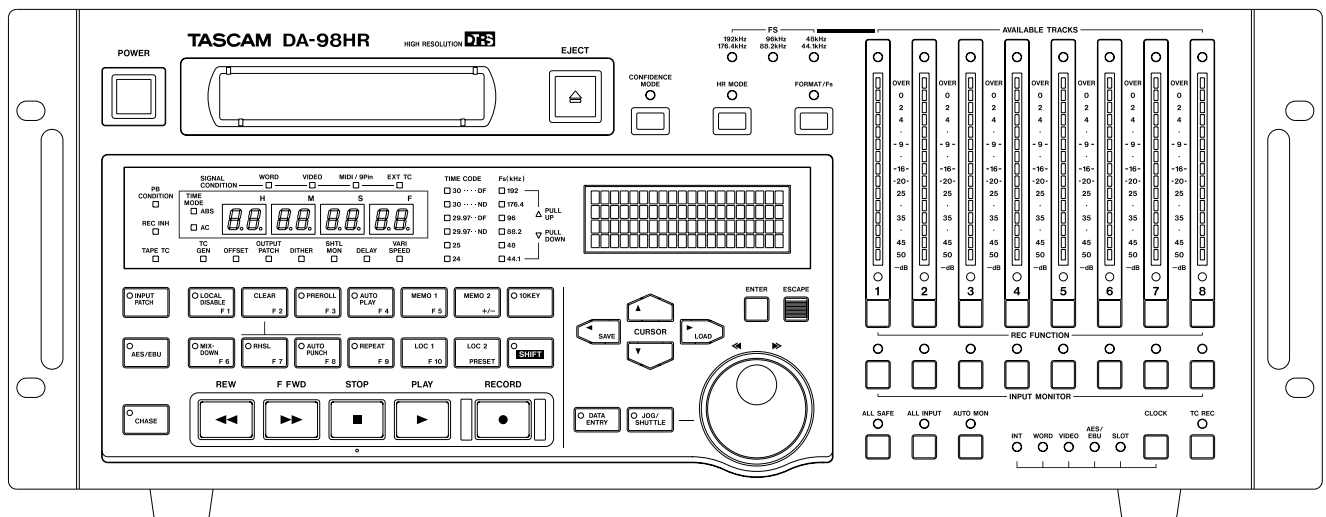

OWNER'S MANUAL



CAUTION: TO REDUCE THE RISK OF ELECTRIC SHOCK, DO NOT REMOVE COVER (OR BACK). NO USER-SERVICEABLE PARTS INSIDE. REFER SERVICING TO QUALIFIED SERVICE PERSONNEL.



The lightning flash with arrowhead symbol, within an equilateral triangle, is intended to alert the user to the presence of uninsulated "dangerous voltage" within the product's enclosure that may be of sufficient magnitude to constitute a risk of electric shock to persons.



The exclamation point within an equilateral triangle is intended to alert the user to the presence of important operating and maintenance (servicing) instructions in the literature accompanying the appliance.

This appliance has a serial number located on the rear panel. Please record the model number and serial number and retain them for your records.

Model number _____
 Serial number _____

WARNING: TO PREVENT FIRE OR SHOCK HAZARD, DO NOT EXPOSE THIS APPLIANCE TO RAIN OR MOISTURE.

Important Safety Precautions

IMPORTANT (for U.K. Customers)

DO NOT cut off the mains plug from this equipment.

If the plug fitted is not suitable for the power points in your home or the cable is too short to reach a power point, then obtain an appropriate safety approved extension lead or consult your dealer.

If nonetheless the mains plug is cut off, remove the fuse and dispose of the plug immediately, to avoid a possible shock hazard by inadvertent connection to the mains supply.

If this product is not provided with a mains plug, or one has to be fitted, then follow the instructions given below:

IMPORTANT: The wires in this mains lead are coloured in accordance with the following code:

GREEN-AND-YELLOW	: EARTH
BLUE	: NEUTRAL
BROWN	: LIVE

WARNING: This apparatus must be earthed.

As the colours of the wires in the mains lead of this apparatus may not correspond with the coloured markings identifying the terminals in your plug proceed as follows:

The wire which is coloured GREEN-and-YELLOW must be connected to the terminal in the plug which is marked by the letter E or by the safety earth symbol \equiv or coloured GREEN or GREEN-and-YELLOW.

The wire which is coloured BLUE must be connected to the terminal which is marked with the letter N or coloured BLACK.

The wire which is coloured BROWN must be connected to the terminal which is marked with the letter L or coloured RED.

When replacing the fuse only a correctly rated approved type should be used and be sure to re-fit the fuse cover.

IF IN DOUBT — CONSULT A COMPETENT ELECTRICIAN.

For U.S.A

TO THE USER

This equipment has been tested and found to comply with the limits for a Class A digital device, pursuant to Part 15 of the FCC Rules. These limits are designed to provide reasonable protection against harmful interference when the equipment is operated in a commercial environment. This equipment generates, uses, and can radiate radio frequency energy and, if not installed and used in accordance with the instruction manual, may cause harmful interference to radio communications.

Operation of this equipment in a residential area is likely to cause harmful interference in which case the user will be required to correct the interference at his own expense.

CAUTION

Changes or modifications to this equipment not expressly approved by TEAC CORPORATION for compliance could void the user's authority to operate this equipment.

For the consumers in Europe

WARNING

This is a Class A product. In a domestic environment, this product may cause radio interference in which case the user may be required to take adequate measures.

Pour les utilisateurs en Europe

AVERTISSEMENT

Il s'agit d'un produit de Classe A. Dans un environnement domestique, cet appareil peut provoquer des interférences radio, dans ce cas l'utilisateur peut être amené à prendre des mesures appropriées.

Für Kunden in Europa

Warnung

Dies is eine Einrichtung, welche die Funk-Entstörung nach Klasse A besitzt. Diese Einrichtung kann im Wohnbereich Funkstörungen verursachen ; in diesem Fall kann vom Betreiber verlang werden, angemessene Maßnahmen durchzuführen und dafür aufzukommen.

IMPORTANT SAFETY INSTRUCTIONS

CAUTION:

- Read all of these Instructions.
- Save these Instructions for later use.
- Follow all Warnings and Instructions marked on the audio equipment.

- 1) Read Instructions** — All the safety and operating instructions should be read before the product is operated.
- 2) Retain Instructions** — The safety and operating instructions should be retained for future reference.
- 3) Heed Warnings** — All warnings on the product and in the operating instructions should be adhered to.
- 4) Follow Instructions** — All operating and use instructions should be followed.
- 5) Cleaning** — Unplug this product from the wall outlet before cleaning. Do not use liquid cleaners or aerosol cleaners. Use a damp cloth for cleaning.
- 6) Attachments** — Do not use attachments not recommended by the product manufacturer as they may cause hazards.
- 7) Water and Moisture** — Do not use this product near water — for example, near a bath tub, wash bowl, kitchen sink, or laundry tub; in a wet basement; or near a swimming pool; and the like.
- 8) Accessories** — Do not place this product on an unstable cart, stand, tripod, bracket, or table. The product may fall, causing serious injury to a child or adult, and serious damage to the product. Use only with a cart, stand, tripod, bracket, or table recommended by the manufacturer, or sold with the product. Any mounting of the product should follow the manufacturer's instructions, and should use a mounting accessory recommended by the manufacturer.
- 9)** A product and cart combination should be moved with care. Quick stops, excessive force, and uneven surfaces may cause the product and cart combination to overturn.



- 10) Ventilation** — Slots and openings in the cabinet are provided for ventilation and to ensure reliable operation of the product and to protect it from overheating, and these openings must not be blocked or covered. The openings should never be blocked by placing the product on a bed, sofa, rug, or other similar surface. This product should not be placed in a built-in installation such as a bookcase or rack unless proper ventilation is provided or the manufacturer's instructions have been adhered to.
- 11) Power Sources** — This product should be operated only from the type of power source indicated on the marking label. If you are not sure of the type of power supply to your home, consult your product dealer or local power company. For products intended to operate from battery power, or other sources, refer to the operating instructions.
- 12) Grounding or Polarization** — This product may be equipped with a polarized alternating-current line plug (a plug having one blade wider than the other). This plug will fit into the power outlet only one way. This is a safety feature. If you are unable to insert the plug fully into the outlet, try reversing the plug. If the plug should still fail to fit, contact your electrician to replace your obsolete outlet. Do not defeat the safety purpose of the polarized plug.
- 13) Power-Cord Protection** — Power-supply cords should be routed so that they are not likely to be walked on or pinched by items placed upon or against them, paying particular attention to cords at plugs, convenience receptacles, and the point where they exit from the product.
- 14) Outdoor Antenna Grounding** — If an outside antenna or cable system is connected to the product, be sure the antenna or cable system is grounded so as to provide some protection against voltage surges and built-up static charges. Article 810 of the National Electrical Code, ANSI/NFPA 70, provides information with regard to proper grounding of the mast and supporting structure, grounding of the lead-in wire to an antenna discharge unit, size of grounding conductors, location of antenna-discharge unit, connection to grounding electrodes, and requirements for the grounding electrode.

"Note to CATV system installer:

This reminder is provided to call the CATV system installer's attention to Section 820-40 of the NEC which provides guidelines for proper grounding and, in particular, specifies that the cable ground shall be connected to the grounding system of the building, as close to the point of cable entry as practical.

Example of Antenna Grounding as per National Electrical Code, ANSI/NFPA 70

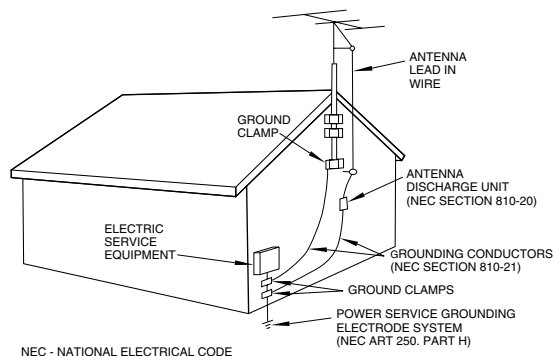

- 15) Lightning** — For added protection for this product during a lightning storm, or when it is left unattended and unused for long periods of time, unplug it from the wall outlet and disconnect the antenna or cable system. This will prevent damage to the product due to lightning and power-line surges.
- 16) Power Lines** — An outside antenna system should not be located in the vicinity of overhead power lines or other electric light or power circuits, or where it can fall into such power lines or circuits. When installing an outside antenna system, extreme care should be taken to keep from touching such power lines or circuits as contact with them might be fatal.
- 17) Overloading** — Do not overload wall outlets, extension cords, or integral convenience receptacles as this can result in risk of fire or electric shock.
- 18) Object and Liquid Entry** — Never push objects of any kind into this product through openings as they may touch dangerous voltage points or short-out parts that could result in a fire or electric shock. Never spill liquid of any kind on the product.
- 19) Servicing** — Do not attempt to service this product yourself as opening or removing covers may expose you to dangerous voltage or other hazards. Refer all servicing to qualified service personnel.
- 20) Damage Requiring Service** — Unplug this product from the wall outlet and refer servicing to qualified service personnel under the following conditions:
 - a) when the power-supply cord or plug is damaged.
 - b) if liquid has been spilled, or objects have fallen into the product.
 - c) if the product has been exposed to rain or water.
 - d) if the product does not operate normally by following the operating instructions. Adjust only those controls that are covered by the operating instructions as an improper adjustment of other controls may result in damage and will often require extensive work by a qualified technician to restore the product to its normal operation.
 - e) if the product has been dropped or damaged in any way.
 - f) when the product exhibits a distinct change in performance — this indicates a need for service.
- 21) Replacement Parts** — When replacement parts are required, be sure the service technician has used replacement parts specified by the manufacturer or have the same characteristics as the original part. Unauthorized substitutions may result in fire, electric shock, or other hazards.
- 22) Safety Check** — Upon completion of any service or repairs to this product, ask the service technician to perform safety checks to determine that the product is in proper operating condition.
- 23) Wall or Ceiling Mounting** — The product should be mounted to a wall or ceiling only as recommended by the manufacturer.
- 24) Heat** — The product should be situated away from heat sources such as radiators, heat registers, stoves, or other products (including amplifiers) that produce heat.

Table of Contents

1 – Introduction to the DA-98HR

1.1 Unpacking	7
1.2 Features.....	7
1.3 Using this manual.....	8
1.3.1 How this manual is organized.....	8
1.3.2 Typographic conventions	8
1.4 Notes and precautions	8
1.4.1 Clock source in a digital studio	9
1.4.2 Confidence replay	9
1.4.3 Environmental conditions	9
1.4.4 Installing the DA-98HR	9
1.4.5 Electrical considerations.....	9
1.4.6 Condensation	10
1.5 Recommended tapes.....	10
1.5.1 Tape brands.....	11
1.5.2 Available recording and playback time.....	11

2 – Front and rear panels

2.1 Front Panel controls.....	12
2.2 Rear Panel connectors.....	17

3 – Connections

3.1 Audio connection	19
3.1.1 Analog audio connections (optional IF-AN98HR).....	19
3.1.2 Digital audio connections (using TDIF-1)	19
3.1.3 Digital audio connections (using AES/EBU)19	
3.2 Synchronization connections.....	20
3.2.1 Analog timecode connections	20
3.2.2 Video connections	20
3.2.3 Word sync clock connections	20
3.3 Control connections.....	21
3.3.1 RS-422 connector.....	21
3.3.2 MIDI connectors (IN , OUT and THRU)	21
3.3.3 Parallel control	21
3.4 Connection to other TASCAM units.....	21
3.4.1 Multiple DTRS units	21
3.4.2 “Indirect” word sync.....	21
3.4.3 Meter unit (MU-8824).....	22

4 – Menu operations

4.1 The menus.....	23
4.1.1 Navigation around the menu system	23
4.1.2 Using the ENTER key.....	23
4.1.3 The ESCAPE key	23
4.1.4 Editing values	23
4.1.5 Resetting a menu value	24
4.1.6 Changing menu values fast	24
4.1.7 Using the dial to change values	24
4.1.8 Blanking the screen display.....	24
4.2 About the function keys.....	24
4.2.1 Function key modes	24
4.2.2 The SHIFT key and function keys.....	25
4.3 Assigning menus to function keys	25

4.3.1 To assign a menu screen to a key	25
4.3.2 Recalling an assigned menu function.....	25
4.4 Using the function keys as number keys ...	25

5 – Monitoring modes

5.1 Monitoring controls.....	27
5.1.1 ALL INPUT and INPUT MONITOR	27
5.1.2 AUTO MON.....	27
5.1.3 Shuttle monitoring	27
5.2 Patching the outputs.....	28
5.3 Confidence mode	28
5.3.1 Arming tracks in pairs	29
5.3.2 Using confidence mode.....	29
5.4 Mixdown patchbay	29
5.4.1 Turning on the MIXDOWN mode.....	29
5.4.2 Selecting the mixdown sources	30
5.4.3 Setting mixdown levels	30

6 – Basic Operations

6.1 Word sync settings	31
6.1.1 Selecting the word sync clock.....	31
6.1.2 Setting the AES/EBU channel for the word sync source.....	31
6.1.3 Clock range with slot board.....	31
6.2 Formatting a tape	32
6.2.1 Available tracks.....	32
6.2.2 The format process.....	32
6.2.3 Aborting the format process.....	33
6.2.4 Recording while formatting.....	33
6.3 Recording the first tracks	33
6.3.1 Preparing to record.....	34
6.3.2 Selecting the digital source	34
6.3.3 Selecting input sources.....	34
6.3.4 Write-protecting cassettes	34
6.3.5 Recording the basic tracks (i).....	34
6.3.6 Recording the basic tracks (ii).....	35
6.3.7 Replaying the first tracks	35
6.4 Overdubbing	35
6.5 Track bouncing.....	35
6.6 Punch-in and punch-out	35
6.6.1 Overview of punch procedures	36
6.6.2 Automatic punch point setting	36
6.6.3 Setting punch points “on the fly”.....	36
6.6.4 Setting and editing punch points using the menus.....	37
6.6.5 Editing the preroll and postroll times	37
6.6.6 Rehearsing the punch-in.....	38
6.6.7 Interrupting a rehearsal or punch recording38	
6.6.8 Recording the punch-in.....	38
6.6.9 Reviewing the punched material	39
6.6.10 Exiting punch-in mode	39

7 – Advanced operations

7.1 Autolocation.....	40
7.1.1 Setting MEMO 1 and MEMO 2 “on the fly” ...	40

7.1.2 Checking, editing and manually entering MEMO 1 and MEMO 2	40	8.5 Digital dubbing	54
7.1.3 Setting the location pre-roll time	40	8.5.1 Synchronized formatting	54
7.1.4 Locating to MEMO 1 and MEMO 2	41	8.5.2 Recording while formatting	55
7.2 Function key location memories	41	8.6 Error messages	55
7.2.1 Storing a function key location memory	41	9 – Operations related to timecode	
7.2.2 Editing function key memories	41	9.1 ABS and SMPTE/EBU timecode	56
7.2.3 Locating to a function key memory	41	9.1.1 ABS time	56
7.2.4 Location and playback	42	9.1.2 Tape timecode	56
7.2.5 Repeat function	42	9.1.3 Selecting TC or ABS timing	56
7.2.6 To start repeat play	42	9.2 Tape timecode mode	57
7.3 Track delay	42	9.2.1 TcTrack setting	57
7.3.1 To set the track delay:	43	9.2.2 ABS setting	57
7.4 Crossfade time	43	9.2.3 ABS-Ofs setting	57
7.5 Vari speed (pitch control)	43	9.2.4 ABS-13 and ABS-23 settings	57
7.5.1 To set a non-standard speed	43	9.2.5 Checking tape TC	58
7.5.2 Resetting the speed to standard	44	9.3 Recording timecode	58
7.6 Shuttle operations	44	9.3.1 Selecting the timecode source	58
7.6.1 Shuttle monitoring	44	9.3.2 Recording timecode using the generator	59
7.6.2 Shuttle muting	45	9.3.3 Recording synthesized timecode from ABS timing	60
7.7 Reference levels	45	9.3.4 Assembling timecode	60
7.8 Meter modes	45	9.3.5 External timecode sources	60
7.8.1 Peak hold time	45	9.3.6 Recording timecode from an analog recorder	61
7.8.2 Meter ballistics	45	9.3.7 Recording timecode from external sources	61
7.9 Sine oscillator	46	9.3.8 Checking external timecode	62
7.9.1 Recording the oscillator	46	9.4 Selecting the frame rate	62
7.10 Digital recording	46	9.4.1 Pull up and pull down (Fs shift)	62
7.10.1 Selecting different inputs for recording	46	9.5 Timecode input and output	62
7.10.2 Selecting input word length	46	9.5.1 Timecode input	63
7.10.3 Setting the high-frequency AES/EBU I/O transfer mode	47	9.5.2 Timecode output	63
7.10.4 Cbit mode	47	9.5.3 Timecode output format	63
7.11 REC MUTE (recording silence)	47	9.5.4 Timecode input and output timing	63
7.11.1 Viewing user bits	47	9.5.5 Using MIDI Time Code (MTC)	64
7.12 Dither	48	9.6 Chasing to timecode	64
7.12.1 Selecting dither settings	48	9.6.1 Machine ID and timecode	64
7.13 Output word length	48	9.6.2 Setting timecode offset	64
7.14 Disabling automatic muting	48	9.6.3 Setting timecode offset from the menu	65
7.15 Setting the power-on message	49	9.6.4 Cancelling timecode offset	65
8 – DTRS synchronization		9.6.5 Setting timecode offset on-the-fly	65
8.1 Synchronization connections	50	9.6.6 Timecode accuracy	65
8.2 Machine ID and master/slave settings	50	9.6.7 Park position	65
8.2.1 Differences between DTRS models	50	9.6.8 Automatic park position setting	65
8.2.2 Setting machine ID	51	9.6.9 Absolute and relative difference	66
8.2.3 Master/slave settings (CHASE mode)	51	9.6.10 Rechasing timecode	66
8.3 DTRS emulation	51	9.6.11 Bypassing timecode errors	67
8.4 Machine offset	52	9.6.12 Individual recording while chasing timecode	67
8.4.1 Setting machine offset	52	9.7 Video resolution	67
8.4.2 Cancelling machine offset	52	9.7.1 Video reference setting	68
8.4.3 Setting machine offset “on the fly”	52	10 – External control	
8.4.4 An example of setting offsets	52	10.1 Selecting the control source (protocol)	69
8.4.5 Clock mode	53		

Table of Contents

10.2 Disabling local control	69	12.2.2 Checking head search time.....	84
10.3 Use with 9-pin external control	69	12.3 Memory backup	84
10.3.1 Video clocking.....	69	12.4 User setups in RAM.....	85
10.3.2 Emulation.....	69	12.4.1 Saving user setups	85
10.3.3 Record delay.....	70	12.4.2 Loading user setups.....	85
10.3.4 Cue-up tally.....	70	12.4.3 Resetting the memory to factory defaults .	85
10.3.5 Fast wind speed	70	12.5 Tape storage of settings	86
10.3.6 Track mapping.....	71	12.5.1 Saving settings to tape.....	86
10.3.7 Timecode track mapping.....	71	12.5.2 Loading settings from tape	86
10.3.8 Remote track arming	72	12.6 Checking version numbers	86
10.4 Bus protocol.....	72	12.6.1 Software upgrades.....	87
10.4.1 Assigning a MIDI and Bus ID to the DA-98HR	72		
10.5 MIDI Machine Control	72		
10.5.1 MMC and the DA-98HR	72		
11 – Menu and parameter reference			
11.1 Menu groups	74		
11.1.1 Menu group 0.....	74		
11.1.2 Menu group 1.....	74		
11.1.3 Menu group 2.....	75		
11.1.4 Menu group 3.....	75		
11.1.5 Menu group 4.....	76		
11.1.6 Menu group 5.....	76		
11.1.7 Menu group 6.....	77		
11.1.8 Menu group 7.....	77		
11.1.9 Menu group 8.....	78		
11.1.10 Menu group 9.....	78		
11.1.11 Menu group A	79		
11.1.12 Menu group B	79		
11.1.13 Menu group D	80		
11.1.14 Menu group E	80		
11.1.15 Menu group F	80		
11.2 Menu item index.....	81		
12 – Maintenance and settings			
12.1 Head and transport cleaning	83		
12.1.1 Daily cleaning	83		
12.1.2 Periodic cleaning	83		
12.2 Checking error rates.....	84		
12.2.1 Checking head time	84		
12.2.2 Checking head search time.....	84		
12.3 Memory backup	84		
12.4 User setups in RAM.....	85		
12.4.1 Saving user setups	85		
12.4.2 Loading user setups.....	85		
12.4.3 Resetting the memory to factory defaults .	85		
12.5 Tape storage of settings	86		
12.5.1 Saving settings to tape.....	86		
12.5.2 Loading settings from tape	86		
12.6 Checking version numbers	86		
12.6.1 Software upgrades.....	87		
13 – Options/specifications/reference			
13.1 DA-98HR options	88		
13.1.1 Accuride® mounting.....	88		
13.1.2 Remote control units (RC-898, RC-848 and RC-828)	88		
13.1.3 Meter unit (MU-8824).....	88		
13.1.4 Cables	88		
13.2 Specifications	89		
13.2.1 Physical specifications.....	89		
13.2.2 Power specifications	89		
13.2.3 Digital recording characteristics	89		
13.2.4 Tape recorder section.....	89		
13.2.5 Tape transport.....	89		
13.2.6 Inputs and outputs.....	89		
13.2.7 Recorder chaacteristics	90		
13.2.8 9-pin (RS-422), MIDI, synchronizer specifications	90		
13.3 MMC Bit Map Array.....	91		
13.4 MIDI Implementation Chart	93		
13.5 MIDI Control Change	94		
13.6 MIDI System Exclusive.....	94		
13.6.1 Identity Reply.....	94		
13.6.2 TASCAM Exclusive messages.....	94		
13.6.3 Track delay	94		
13.6.4 Crossfade	94		
13.6.5 Machine offset.....	94		
13.6.6 Input Patch setup.....	95		

The TASCAM DA-98HR is a digital audio multi-track recorder designed for use in a variety of applications, including video post-production and audio multitrack work.

It records up to 8 tracks of full-quality digital audio on standard Hi8 video cassettes using a specially-designed transport and head mechanism. Using this medium, up to 108 minutes of continuous recording is possible on a single NTSC “120” tape.

Recording is carried out at either 24 bits or 16 bits of resolution, and digital data may be input at 16, 20 or 24 bits of resolution.

As well as the “traditional” industry-standard 44.1 kHz and 48 kHz sampling frequencies, the DA-98HR can also record and playback at double and four times these sampling frequencies: 88.2 kHz and 176.4 kHz, and 96 kHz and 192 kHz.

The DA-98HR builds on the foundations laid by the TASCAM DA-78HR, DA98, DA-88 and DA-38 digital multitrack recorders, and retains compatibility with them. Tapes recorded on one of the DTRS series can be replayed and overdubbed on any other machine in the series, or any DTRS¹ machine, subject to the word length and sampling frequency capabilities of both machines.

NOTE

Recording is an art as well as a science. A successful recording is often judged primarily on the quality of sound as art, and we obviously cannot guarantee that. A company that makes paint and brushes for artists cannot say that the paintings made with their products will be critically well-received. TASCAM can make no guarantee that the DA-98HR by itself will assure the quality of the recordings you make. Your skill as a technician and your abilities as an artist will be significant factors in the results you achieve.

1.1 Unpacking

The box contains the following.

- DA-98HR Digital Multitrack Recorder (x 1)
- Rackmount screw kit (x 1)
- AC power cord, 2 m (6 ft.) long (x 1)
- This manual (x 1)
- Warranty card (x 1)
- Quick Start guide (x 1)
- HC-8 cleaning tape

1.DTRS is a trademark of TEAC Corporation

1.2 Features

Key features of the DA-98HR include:

- TASCAM-exclusive high-performance/high wear resistive rotary 4-head mechanism with TASCAM original track layout (DTRS standard)
- Use of standard, low-cost media with long recording and playback times
- 16-bit or 24-bit recording
- “Traditional” and high-speed sampling rates for ultimate sonic performance
- Different sampling frequencies can be recorded simultaneously on different tracks on the same tape, providing ultimate flexibility
- Fast, frame-accurate tape location and positioning; end-to-end winding for a “120” tape is around 80 seconds
- Direct digital synchronization of up to 16 DTRS recorders (128 tracks) without the use of any external synchronizer or controller
- Direct digital dubbing between DTRS units
- Input patchbay provides an internal digital patchbay, allowing input-to-track assignment without the use of external equipment
- Output patchbay allows the routing of tracks to outputs without the need for external equipment
- 15-segment peak meters with user-selectable fall ballistics and variable hold time (including continuous peak hold)
- Integral digital sine oscillator, providing signals at 440Hz for tuning and 1kHz for lineup purposes
- Digital input and output in TDIF-1 format on a single convenient compact D-sub connector
- Eight channels of AES/EBU I/O on a single convenient compact D-sub connector
- Two expansion slots allow the use of optional accessory boards, such as analog I/O, optimized for use with the DA-98HR
- Settings carried out through a menu hierarchy using a 20-character x 4-line LCD display with cursor keys and an ENTER/ESCAPE system
- The 10 most commonly-used functions can be assigned to “soft keys” for easy recall
- Full SMPTE/EBU timecode synchronization, including on-board timecode generator
- MIDI Time Code and MIDI Machine Control
- Confidence replay mode, allowing off-tape monitoring while recording is in progress

1 – Introduction to the DA-98HR—Using this manual

- Input monitor mode allows channel-by-channel source monitoring, regardless of tape transport status
- Three user setup memory banks for storing setup profiles
- Simplified source/tape monitoring functions with automatic switching
- Auto punch-in and punch-out with rehearsal mode
- 2-point full function autolocator with A–B repeat function, and 10 “soft key” location memories
- Variable speed recording and playback (up to 6.0% in 0.1% steps)
- Shuttle mode enables “rock and roll” audio positioning of key locations

1.3 Using this manual

We suggest that you take the trouble to read this manual through at least once before starting to use the DA-98HR. In this way, you will find out where to turn when you need answers.

1.3.1 How this manual is organized

1, “Introduction to the DA-98HR”: This section, giving a general guide to the features and capabilities of the unit.

2, “Front and rear panels”: A general guide to the front panel controls and rear panel connectors of the DA-98HR, and their general function.

3, “Connections”: Some hints and tips about connecting the DA-98HR to other equipment in a digital recording setup.

4, “Menu operations”: The parameters and settings of the DA-98HR are controlled using a menu system. Although this is easy to use, we suggest that you read this section carefully in order to understand how to use this menu system.

5, “Monitoring modes”: Careful monitoring is essential to making good recordings, and the DA-98HR provides many monitoring modes. We suggest that you read this section carefully to understand the different options available to you.

6, “Basic Operations”: The standard operations concerning recording using the DA-98HR.

7, “Advanced operations”: Operations that you will not necessarily perform every day, but are necessary for the successful operation of the DA-98HR.

8, “DTRS synchronization”: You should read this section when you use the DA-98HR with other DTRS units.

9, “Operations related to timecode”: When you are synchronizing units, including the DA-98HR, in your setup to timecode, you should read this section carefully to make sure that you understand the options available to you.

10, “External control”: The DA-98HR can be controlled externally using 9-pin serial controllers as well as by MIDI (MMC) controllers. Read this section for details of the options available.

11, “Menu and parameter reference”: Use this section as reference for the parameters available, and the way in which they are accessed.

12, “Maintenance and settings”: Read this section to learn how to maintain the DA-98HR in top condition, as well as to store and retrieve settings for further use.

13, “Options/specifications/reference”: Specifications, etc. and details of options available for use with the DA-98HR.

1.3.2 Typographic conventions

When referring to a control or a connector on the DA-98HR, the name of the control or connector will be written in bold type, and will often be followed by a circled number, as in the example below:

Holding down the PLAY (32) and pressing the RECORD (33) key will start the recording process.

The numbers refer to the front and rear panel illustrations and description in 2, “Front and rear panels”.

When referring to a word or phrase which appears on the LCD display screen, the word or phrase will be written as follows:

Move the cursor to Memo 1.

Sometimes the tape counter is used to display a message. This will be shown as follows:

The tape counter shows -L oAd--.

1.4 Notes and precautions

As with any precision piece of electronic equipment, common-sense precautions apply with the DA-98HR.

However, there are a few extra notes and precautions which apply to using the DA-98HR, and we suggest

1 – Introduction to the DA-98HR–Notes and precautions

that you make a note of these, to prolong the useful life of the DA-98HR.

1.4.1 Clock source in a digital studio

The DA-98HR can be used in a variety of situations, and with a variety of equipment, either digital or analog.

If you are working with more than one digital audio unit in your setup, you should note that all units must be driven by the same central clock source (“word clock” or “word sync”).

If different word clock sources are used throughout the setup, it is actually possible to damage speakers, etc. because of mismatches.

The DA-98HR can be designated as the word clock master for your studio, or can be slaved to external word clocks, using a convenient front-panel switch and standard BNC connectors.

Even though AES/EBU stereo digital audio signals are self-clocking, any AES/EBU format signals fed to or from the DA-98HR must be synchronized at word level with the DA-98HR.

1.4.2 Confidence replay

Because the DA-98HR can accept digital data at different sampling frequencies, and the word length is may be either 16 or 24 bits, monitoring the input source during recording will not necessarily provide a completely accurate representation of what is recorded on tape.

The DA-98HR provides a dither setting (7.12.1, “Selecting dither settings”) which provides improved total harmonic distortion figures for 16-bit recording. Since the dither is applied prior to recording, again, monitoring the input source will not allow you to hear the effect of the dithering process.

Accordingly, the DA-98HR provides a confidence mode, allowing you to monitor off-tape as recording progresses. Since this monitoring is not synchronized exactly with the source inputs, gapless punch-in and punch-out is not possible in confidence mode. For full details of confidence monitoring, together with other monitoring modes available on the DA-98HR, see 5, “Monitoring modes”.

1.4.3 Environmental conditions

The DA-98HR can be operated in most environments, but we suggest that you keep the environmental conditions within the following limits:

Ambient temperature between 5° and 35° C (41° and 95° F).

Relative humidity should be between 30% and 80% non-condensing

There should be no strong magnetic fields (speakers, etc.) near the DA-98HR.

Avoid spraying polish, insecticides, etc. near the DA-98HR.

NOTE

If you need to clean the DA-98HR, use a soft cloth, moistened if necessary with a little detergent and water. Do not use abrasive cleaners or solvents such as alcohol or thinner.

Avoid subjecting the DA-98HR to jolts, sudden shocks, etc.

NOTE

If you have to return the unit for service or repair, use the original packing materials if possible. If the unit is to be transported to a recording location, etc., use a suitable transport case with sufficient shock protection.

TASCAM does not accept responsibility for damage resulting from neglect or accident.

1.4.4 Installing the DA-98HR

The DA-98HR may be installed in a standard 19” rack, occupying 4U of space. Since the DA-98HR is quite heavy (around 11kg – 24lb), your rack should be strong and stable to take the weight of the DA-98HR.

The DA-98HR should be mounted with the front panel vertical.

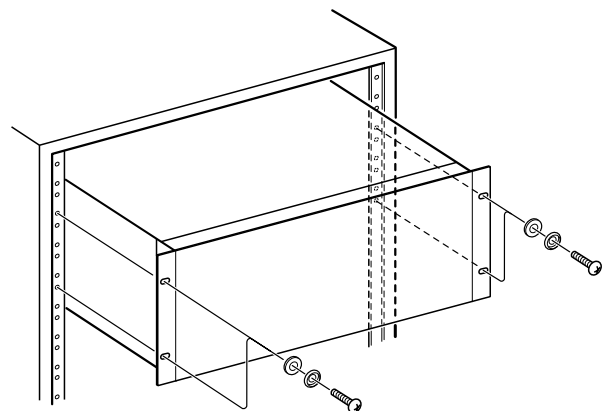

1.4.5 Electrical considerations

Make sure that your local power supply matches the voltage requirements marked on the rear panel of the DA-98HR.

If you are in any doubt concerning the local power supply, consult an electrician.

1 – Introduction to the DA-98HR–Recommended tapes

Avoid extreme voltage fluctuations. If necessary, use an input voltage regulator to smooth the power supplied to the DA-98HR.

Do not open the unit to clean inside, or to perform any internal adjustments. You should not attempt any cleaning or other maintenance procedures which are not described in this manual.

You may need to clean the heads occasionally. The procedure for doing this, and for checking tape error rates, etc., is given in 12, “Maintenance and settings”.

1.4.6 Condensation

If you use the DA-98HR in a warm place after moving it from a cold place (for instance, recording on location), or if there has been a sudden change in temperature, condensation may occur within the tape mechanism, with a risk of possible damage to the unit.

If condensation does occur, you will not be able to operate the DA-98HR controls, and you will see the following message on the display:

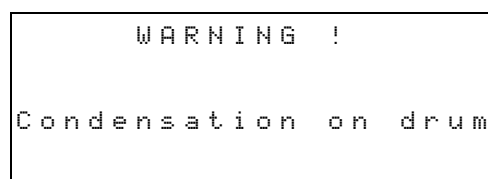

If you see the above message, press the **ESCAPE** key to remove the message, leave the DA-98HR switched on for one or two hours, then switch it off and on again before starting recording.

If you are going to use the DA-98HR in a location where you think condensation is likely to occur, move the DA-98HR into the warmer location about one or two hours before recording is due to start, and leave it switched on. Turn the DA-98HR off and then on again before starting recording.

1.5 Recommended tapes

The DA-98HR is designed for use with Hi8 video cassettes. You cannot use any other kind of tape with the DA-98HR.

There are two basic types of Hi8 tape: MP and ME. Each has its own particular characteristics and merits:

- MP tapes are manufactured using a daubed magnetic particle deposit process and exhibit a level of performance which is more than acceptable. They have a durability which allows them to be used as work tapes in studio and post-production environments.
- ME tapes have their magnetic layer produced through a metal evaporation process. Generally speaking, though these tapes have a high performance level, they are not as robust as MP tapes (see above) and should be used for live recording and archival purposes, rather than as work tapes.







TASCAM does not endorse any specific tape or tape manufacturer. TASCAM has licensed the use of the DTRS logo (™) to tape manufacturers, provided their tape meets the specifications required by DTRS tape recorders. However, the use of the DTRS logo on the tape packaging does not imply any endorsement of the tape by TASCAM. It is possible that the characteristics and sensitivities of tapes may be changed by the manufacturers without notice. The brands and model numbers of tapes listed below may not always meet the specifications required by DTRS systems for optimum performance. TASCAM assumes no responsibility for problems resulting from changes made by a manufacturer to the materials or specifications of its tape products.

The electrical characteristics of DTRS recorders are adjusted and set using Sony Hi8 tape parameters (MP and ME) prior to shipment.

1 – Introduction to the DA-98HR–Recommended tapes

1.5.1 Tape brands

The following brands and models of tape can be used with the DA-98HR. As mentioned above, this list does not constitute any endorsement by TASCAM of these products, nor is it a guarantee that tapes bearing this brand and model name will continue to give optimum performance.

Maker	MP	ME
Fuji	DPD-MP 	
Quantegy	DA8 MP 	
BASF	DA MP 	
HHB	DA113 	
Maxell	DRS-113DA (P) 	
Sony	P6-HMP	E5-HME
	P6-HMPX	E6-HMEAD
	P5-HMP	E5-HMEAD
	P5-HMPX	E6-HMEX
		E5-HMEX
	DARS-MP 	E6-HME

The electronics of DTRS recorders are designed to operate within specific parameters. The use of a tape with sensitivity higher or lower than that of tapes for which the DTRS recorder was originally designed may cause an error in functionality or prevent the user from getting optimum performance from the tape. Always use the shortest possible tape for a given project. Do not attempt to use 150-minute or longer tapes in DTRS machines, as the machine will detect the thickness of tape and automatically eject any tape thinner than recommended.

Never attempt to use a tape with the DA-98HR that has previously been used in video equipment.

NOTE

You cannot cut and splice DTRS 8mm tapes for editing purposes. Using a spliced tape in the DA-98HR will invariably result in serious damage to the heads, requiring replacement. All editing must be done digitally.

1.5.2 Available recording and playback time

Depending on whether the tape has been purchased for use with an NTSC (P6/E6) or a PAL/SECAM (P5/E5) television system, the same length of tape (as far as video length is concerned) will provide different times for audio work, as shown below, due to different frame rates between television systems. The indication P6/E6 or P5/E5 will be printed on the tape package:

Time on tape label	P6/E6 (NTSC tape)	P5/E5 (PAL/SECAM tape)
20	18	25
30	27	37
45	40	56
60	54	75
90	81	113
120	108	–

2 – Front and rear panels

2.1 Front Panel controls

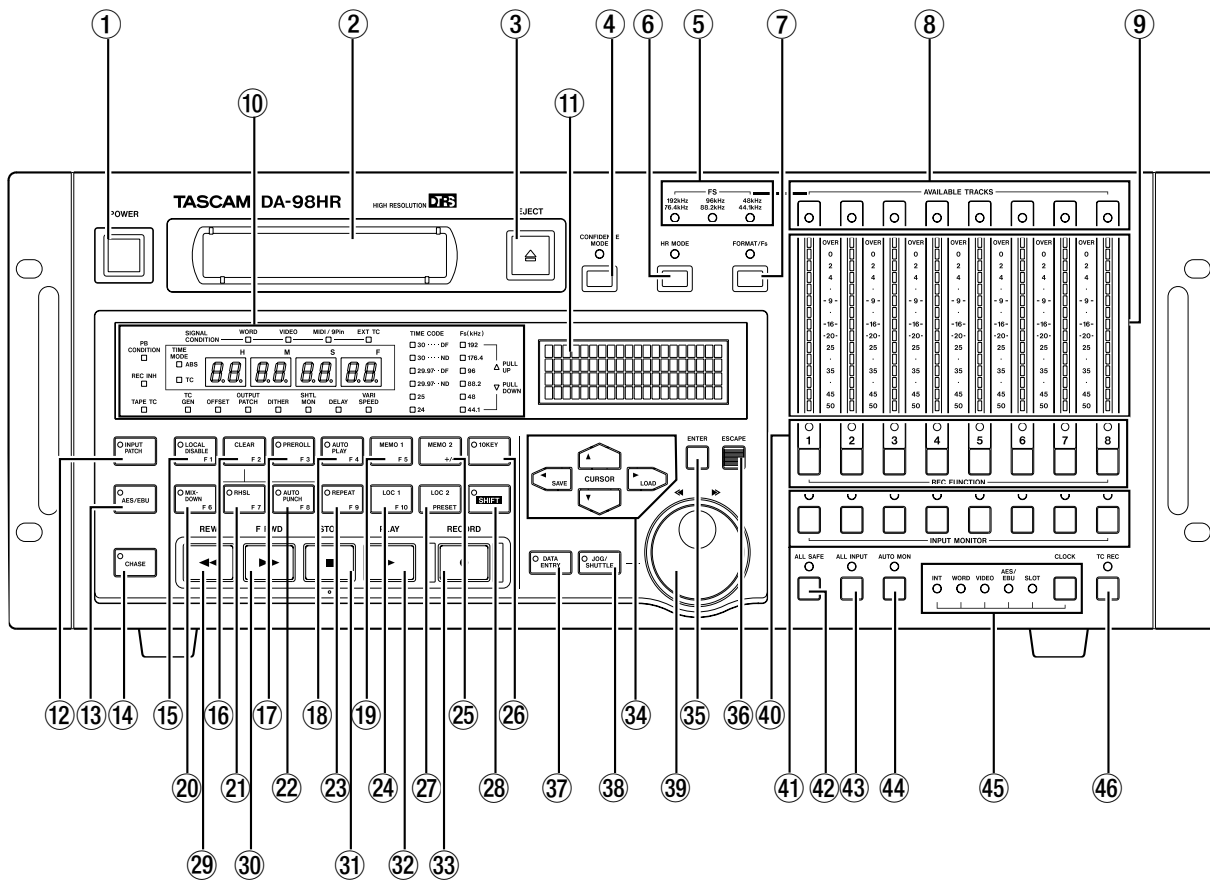

① Power switch

Turns the power to the DA-98HR on and off. When the DA-98HR is turned off, settings will be retained in memory (12.3, “Memory backup”).

② Tape loading slot

Only use Hi8 ME or MP tapes as specified in 1.5, “Recommended tapes”. The DA-98HR will automatically eject all other tapes.

NOTE

Do not use a tape which has been used for recording video. Always use either new tapes or tapes which have been used in a DTRS recorder.

③ EJECT key

Ejects any loaded cassette. A cassette can only be ejected when the transport is stopped.

④ CONFIDENCE MODE key and indicator

The DA-98HR features a confidence replay mode which allows off-tape monitoring. This key and indi-

cator allow selection and viewing of the status of this monitoring mode.

For a full explanation of confidence monitoring, see 5.3, “Confidence mode”.

⑤ Fs indicators

These indicators (**192kHz/176.4kHz**, **96kHz/88.2kHz** and **48kHz/44.1kHz**) light to show what sampling frequencies are currently being used for recording.

⑥ HR MODE key and indicator

This key controls whether a tape will be formatted to record at 24-bit high resolution or 16-bit resolution. The indicator shows the status of the recording resolution while formatting, or if a previously-formatted tape has been loaded.

⑦ FORMAT/Fs key and indicator

The **FORMAT** indicator shows the tape formatting status. The **FORMAT/Fs** key controls the formatting of tapes and allows selection of the sampling frequencies to be used for recording (see 6.2, “Formatting a tape” for full details).

⑧ AVAILABLE TRACK indicators

These tri-color indicators light when a track is available for recording, and the color shows the frequency at which the track will be recorded (as also shown by the **FORMAT/Fs** indicators ⑦).

⑨ Peak meters

These 15-segment peak meters show the input level or the recorded signal level, depending on the monitoring mode currently in operation (5, “Monitoring modes”). The ballistics and peak hold times are selectable (7.8.2, “Meter ballistics”).

NOTE

When using digital recording equipment, there is no headroom above the 0dB mark and no tape saturation is possible. Any signal which causes the “OVER” segment to light will cause audible distortion. For this reason you should take care not to let recording levels exceed this level.

⑩ Tape counter and status indicators

The tape counter gives the time in hours, minutes, seconds and frames.

The status indicators show the current status of various DA-98HR functions. The legends of these indicators are abbreviated for reasons of space. Here is a list of their full meanings, together with the pages on which the functions are more fully described:

Legend	Meaning
SIGNAL CONDITION (WORD, VIDEO, MIDI/ 9PIN & EXT TC)	Show the conditions of the appropriate inputs
PB CONDITION	Playback condition (tape errors)
REC INHI	Recording is inhibited (the cassette’s write-protect tab is set)
TAPE TC	Shows the condition of the tape timecode track
TIME MODE (ABS & TC)	Shows the timing reference currently being used
TC GEN	Lights when the internal timecode generator is generating
OFFSET	Machine offset is in operation
OUTPUT PATCH	Shows that the output patchbay is in operation
DITHER	Shows that dither mode is on
SHTL MON	Shows that the shuttle monitor mode is active
DELAY	Shows that at least one of the tracks has a non-zero delay time set
VARI SPEED	Lights when the DA-98HR’s vari speed function is enabled

The **TIME CODE** indicators show the timecode format currently in use. This can be any of the following: **30** (drop-frame **DF** or non-drop **ND**), **29.97** (drop-frame **DF** or non-drop **ND**), **25** or **24** fps.

The **Fs(kHz)** indicators show the current clock frequency (from the selected word sync source). The values are shown by the appropriate indicators here, and can be **192**, **176.4**, **96**, **88.2**, **48** or **44.1** (all kHz).

If pull-up or pull-down has been selected for telecine work, etc., the appropriate indicator (**PULL UP**, **PULL DOWN**) will light.

⑪ Display screen

This 20-character by 4-line LCD screen shows the menus and the parameters that can be set in the menus.

⑫ INPUT PATCH key and indicator

This key provides quick and easy access to the input patchbay screen 6.3.3, “Selecting input sources”.

The indicator shows that the patchbay is in use, even when the screen is not displayed. It goes out when all inputs are “normalled”.

⑬ AES/EBU key and indicator

When recording from the built-in digital sources, one of either the TDIF-1 or the AES/EBU connectors may be in use at any time. When replaying, the signals are sent from both the TDIF-1 and the AES/EBU connectors together.

Use this key to change the input source. When this key is off (the indicator is unlit), the TDIF-1 I/O is active, and when the key is on, the AES/EBU I/O is active. See also 6.3.2, “Selecting the digital source”.

⑭ CHASE key and indicator

The **CHASE** key controls whether the DA-98HR’s transport is to “chase” a master machine (indicator is lit when chasing or flashing when preparing to chase) or to operate independently. The chase mode may be either timecode or ABS based (8, “DTRS synchronization” and 9.6, “Chasing to timecode”).

⑮ LOCAL DISABLE (F1) key and indicator

When this key is on (the indicator is lit), the local controls have no effect (except for the **STOP** key), and the unit can be controlled only from a suitable remote control source.

When the **10KEY** indicator ⑳ is on, this key can be used to enter values directly, and when the **SHIFT** key ㉑ is pressed, this key becomes a function key.

2 – Front and rear panels—Front Panel controls

⑩ CLEAR (F2) key

This key defeats the rehearsal and auto modes during auto punch-in and out (6.6, “Punch-in and punch-out”).

When the **10KEY** indicator ⑫ is on, this key can be used to enter values directly, and when the **SHIFT** key ⑳ is pressed, this key becomes a function key.

⑪ PREROLL (F3) and indicator

This key locates the tape to the punch-in point, minus the pre-roll time (see 6.6, “Punch-in and punch-out”). The indicator flashes while this location is taking place.

When the **10KEY** indicator ⑫ is on, this key can be used to enter values directly, and when the **SHIFT** key ⑳ is pressed, this key becomes a function key.

⑫ AUTO PLAY (F4) key and indicator

When this key is pressed (the indicator lights), the DA-98HR will automatically start playing as soon as a preset location point has been reached (7.1, “Autolocation”).

When the **10KEY** indicator ⑫ is on, this key can be used to enter values directly, and when the **SHIFT** key ⑳ is pressed, this key becomes a function key.

⑬ MEMO 1 (F5) key

When pressed, this key stores the current tape position into a memory location point which can be accessed using the **LOC 1** key ⑳. The location can be “nudged” using the menu functions (7.1.2, “Checking, editing and manually entering MEMO 1 and MEMO 2”).

When the **10KEY** indicator ⑫ is on, this key can be used to enter values directly, and when the **SHIFT** key ⑳ is pressed, this key becomes a function key.

⑭ MIXDOWN (F6) key and indicator

When this key is pressed, the mixdown patchbay is in use, outputting a mixed stereo signal from channels 7 and 8. At this time, output from other channels is muted. See 5.4, “Mixdown patchbay” for details.

When the **10KEY** indicator ⑫ is on, this key can be used to enter values directly, and when the **SHIFT** key ⑳ is pressed, this key becomes a function key.

⑮ RHSL (F7) key and indicator

This key and indicator allow selection of the rehearsal mode in auto punch-in and out (6.6, “Punch-in and punch-out”).

When the **10KEY** indicator ⑫ is on, this key can be used to enter values directly, and when the **SHIFT** key ⑳ is pressed, this key becomes a function key.

⑯ AUTO PUNCH (F8) key and indicator

This key and indicator allow automatic punch-in and punch out following rehearsal (6.6, “Punch-in and punch-out”).

When the **10KEY** indicator ⑫ is on, this key can be used to enter values directly, and when the **SHIFT** key ⑳ is pressed, this key becomes a function key.

⑰ REPEAT (F9) key and indicator

When this key is pressed, playback is repeated between the two memory locations set by ⑱ and ㉓ (7.2.6, “To start repeat play”).

When the **10KEY** indicator ⑫ is on, this key can be used to enter values directly, and when the **SHIFT** key ⑳ is pressed, this key becomes a function key.

⑱ LOC 1 (F10) key

This key locates the tape to the position set by **MEMO 1** ⑱.

When the **10KEY** indicator ⑫ is on, this key can be used to enter values directly, and when the **SHIFT** key ⑳ is pressed, this key becomes a function key.

㉓ MEMO 2 (+/-) key

When pressed, this key stores the current tape position into a memory location point which can be accessed using the **LOC 2** key ㉗.

When the function keys are used as number keys (the 10), this key is used as a “sign-change” key.

㉖ 10KEY key and indicator

When this key is on (the indicator is lit), the keys from ⑮ through ㉓ become number keys for direct entry of values.

The digit entered by the keys is the same as that of their function number (**Fx**), except for the **LOC 1/F10** key ⑱, which enters a zero, and the **MEMO 2 / +/-** key ㉓, which is used to change the sign of the entered value.

㉗ LOC 2 (PRESET) key

This key locates the tape to the position set by **MEMO 2** ㉓.

When the **SHIFT** key ⑳ is pressed, this key allows the assignment of the function keys ⑮ through ㉓, (see 4.2.2, “The SHIFT key and function keys”).

⑳ **SHIFT key and indicator**

When this latching key is pressed (the indicator will flash), keys ⑮ through ㉔ become function keys, and the left and right cursor keys are used to save and load settings, respectively.

㉑ **REW key**

Rewinds the tape at high speed.

If this key is pressed during recording, recording will stop and the tape will rewind.

㉒ **F FWD key**

Winds the tape forward at high speed.

If this key is pressed during recording, recording will stop and the tape will wind forward.

NOTE

*When either **REW** or **F FWD** is pressed for the first time after powering up, or loading a tape, the unit first configures itself for the reel hub diameter of the tape in use, during which the tape advances at low speeds. This takes several seconds. Thereafter, the transport momentarily goes into stop mode before the tape starts fast-winding. At the start and end of tapes, the transport momentarily goes into stop mode, and then advances at low speed, to prevent possible damage to tapes.*

㉓ **STOP key**

Cancels any current tape transport mode, and stops the tape.

㉔ **PLAY key**

Starts playing the tape. If this key pressed while recording is in progress, the DA-98HR drops out of record mode.

㉕ **RECORD key**

If the **PLAY** key ㉔ is pressed while the **RECORD** key is held down, recording will start on all armed tracks.

If the DA-98HR is in play mode, and the **REC** key is pressed, recording will start immediately on any armed tracks.

The **RECORD** key also is used to set punch-in points during auto punch-in/out operations (6.6.3, “Setting punch points “on the fly”).

㉖ **CURSOR keys**

These keys are used to navigate the cursor through the menus controlling the DA-98HR functions.

When a menu has been selected, the up and down keys (▲ and ▼) are used to set the values or select the choices within the menu.

The left and right keys (◀ and ▶) are used for cursor navigation.

See 4, “Menu operations” for details of how to use these keys in menu operations.

When the **SHIFT** key ㉒ is active, the left and right keys (◀ and ▶) are used for saving and loading settings from tape (see 12.5, “Tape storage of settings”).

㉗ **ENTER key**

This key is used to confirm settings and to move ‘down’ through the menu system.

㉘ **ESCAPE key**

This key is used as an “exit” key and to move ‘upward’ through the menu system.

㉙ **DATA ENTRY key and indicator**

When this key is on (the indicator is lit), the data entry/jog dial ㉚ can be used to make settings of numerical values, etc. in the menu system.

㉚ **JOG/SHUTTLE key and indicator**

When this key is on (the indicator is lit), the data entry/jog dial ㉚ can be used to cue the tape playback position, in a similar way to “rock and roll” tape cueing on an open-reel tape deck.

㉛ **Data Entry/Jog and Shuttle controls**

These controls consist of two parts, the inner jog dial, and the outer shuttle wheel.

When the **DATA ENTRY** key ㉙ is on (indicator lit), turning the jog dial clockwise increments the current menu parameter value, and turning it counter-clockwise decrements the value.

When the **JOG/SHUTTLE** key ㉚ is on (indicator lit), turning the shuttle wheel to the right provides forward cueing and turning it to the left provides reverse cueing, similar to “rock and roll” on open-reel tape decks. The further the wheel is moved from the center position, the faster the tape speed. In this jog/shuttle mode, the inner jog dial is used to advance or retard the playback position by fractional amounts.

㉜ **REC FUNCTION keys and indicators**

These eight keys and indicators allow the setting and viewing of the record status on a track-by-track basis.

When one of these keys is pressed, the appropriate indicator will flash, the track is “armed”, and going into record mode will start recording on that track. When recording is being carried out on a track, the track’s indicator will light steadily.

2 – Front and rear panels—Front Panel controls

④1 INPUT MONITOR keys and indicators

These keys allow the monitoring of inputs to tracks on a track-by-track basis, irrespective of the current transport status. The appropriate indicator(s) will light when monitoring track input(s) using these keys. Note that the function of these keys is connected with the **ALL INPUT** key ④3.

④2 ALL SAFE key and indicator

This key acts as a ‘safety lock’. When it is on (the indicator is lit), it prevents the arming (and hence the accidental recording) of any tracks.

④3 ALL INPUT key and indicator

When this key is pressed, the indicator will light, and, regardless of the transport mode, all outputs will be switched to the signals derived from the inputs. This is primarily for alignment purposes, and is equivalent to pressing all the **INPUT MONITOR** keys ④1 together.

For a full treatment of monitoring modes on the DA-98HR, see 5, “Monitoring modes”.

④4 AUTO MON key and indicator

When this key is pressed (the indicator will light), the monitoring system of the DA-98HR automatically changes between tape and input monitoring, depending on the transport mode.

For a full treatment of monitoring modes on the DA-98HR, see 5, “Monitoring modes”.

④5 CLOCK key and indicators

This key and these indicators allow you to set and view the system clock. There are five options:

Setting	Meaning
INT	The DA-98HR provides its own clock reference
WORD	The clock is synchronized to the signal received at the WORD SYNC IN connector
VIDEO	The clock is synchronized to the signal received at the VIDEO IN connector
AES/EBU	The clock is synchronized to digital audio received at the AES/EBU connector. The menu system is used to determine the channel from which the DA-98HR takes the clock.
SLOT	The clock is synchronized to the input received at the optional slot input board, or derived from the slot’s clock

④6 TC REC key and indicator

This key is used to record timecode (either internally generated or from an external source) on a dedicated subcode track of the DA-98HR. No audio track is needed to record timecode. For full details of timecode operation, see 9, “Operations related to timecode”

NOTE

*It is not necessary to use timecode if two DTRS units (e.g. DA-88, DA-38 or DA-98 machines) are to be operated together. The **SYNC** connections will ensure synchronization between machines (8, “DTRS synchronization”).*

2.2 Rear Panel connectors

This provides a brief description of the functions of the connectors on the rear panel. For full details of connections, see 3, “Connections”, and for details of levels, etc., see 13.2, “Specifications”.

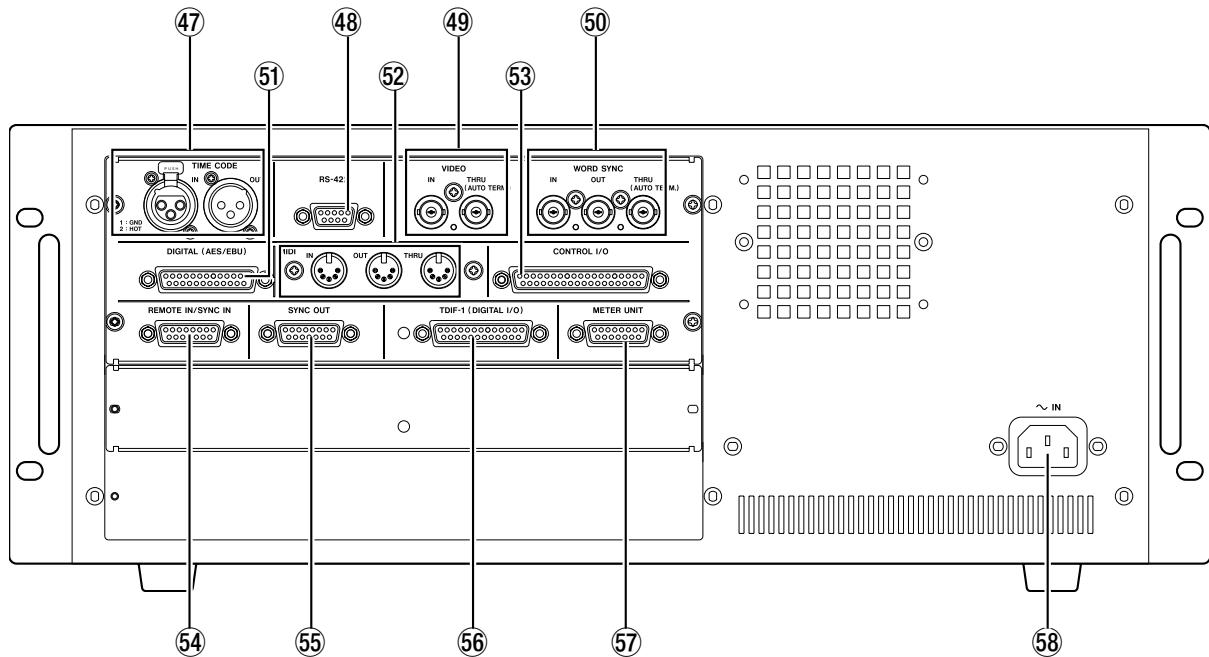

④⑦ TIME CODE (IN and OUT)

This pair of XLR-type connectors (female for **IN** and male for **OUT**) provides the timecode connections for the timecode synchronization functions of the DA-98HR. See 9, “Operations related to timecode” for full details.

④⑧ RS-422

This connector is used for controlling the DA-98HR using controllers or editors which conform to the Sony P2 protocol (RS-422). See 10.3, “Use with 9-pin external control” for full details of how to use other equipment connected through this connector.

④⑨ VIDEO (IN/THRU)

The **VIDEO** BNC connectors are used to carry video frame sync signals when the DA-98HR is used with video equipment. The self-terminating **THRU** connector echoes messages received at the **IN**.

See 9.7, “Video resolution” for details of video sync operation.

④⑩ WORD SYNC (IN/OUT/THRU (AUTO TERM))

These BNC connectors are used to carry the word clock between the DA-98HR and other types of digital audio equipment. The **THRU** connector is self-terminating. See 3.2.3, “Word sync clock connections” for full details.

④① DIGITAL (AES/EBU)

This 25-pin D-sub connector provides I/O in AES-EBU format. The pinouts for this are as follows:

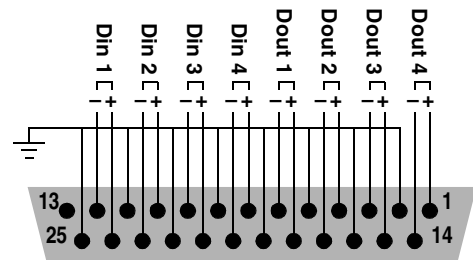

Use a cable which provides suitable XLR-type connectors connected to a 25-pin ‘D’-sub connector, to connect the DA-98HR to the AES/EBU devices.

④② MIDI IN/OUT/THRU

These connectors carry MIDI Time Code (MTC) and MMC (MIDI Machine Control) commands. See 10.5, “MIDI Machine Control” for details of how these facilities are used when synchronizing to other units.

④③ CONTROL I/O

This connector is used for control of the DA-98HR by external equipment. Consult your TASCAM dealer for full details of compatibility and the use of this connector.

2 – Front and rear panels–Rear Panel connectors

The pinout for this connector is given below .

Pin No.	Signal	Pin No.	Signal
1	PLAY	20	SUB GND
2	F FWD	21	SERIAL OUT
3	REW	22	–
4	AUX 1	23	SERIAL IN
5	STOP	24	–
6	REC	25	–
7	AUX 2	26	–
8	CHASE	27	–
9	–	28	–
10	SUB GND	29	–
11	PLAY TALLY	30	–
12	F FWD TALLY	31	–
13	REW TALLY	32	SRCK
14	STOP TALLY	33	–
15	REC TALLY	34	LOAD
16	LOCK TALLY	35	–
17	AUX 1 TALLY	36	SUB GND
18	AUX 2 TALLY	37	SUB 5 V (max 50mA)
19	ACTIVE SENSE		

⑤④ REMOTE IN/SYNC IN

This connector is used to connect another “master” DTRS unit (e.g. DA-98HR, DA-78HR, DA-98, DA-

88 or DA-38). See 8, “DTRS synchronization” for further details.

An RC-898, RC-848 or RC-828 remote control unit may also be connected here, but unless an “HR updated” RC-898 unit is used, not all functions of the DA-98HR will be available from the remote control unit.

⑤⑤ SYNC OUT

This is used to connect another DTRS unit in the “daisy-chain” or, if this DA-98HR is the last unit in the chain, to attach a termination plug.

⑤⑥ TDIF-1 (DIGITAL I/O)

This connector carries eight channels of digital audio to and from the DA-98HR in TEAC Digital Interface Format (TDIF-1).

⑤⑦ METER UNIT

This connector carries power and signals to drive 8 channels of the optional MU-8824 24-channel Meter Unit.

Make the connection using a TASCAM PW-88M cable.

⑤⑧ ~ IN

Use the provided AC power cord to connect the DA-98HR to the AC power supply through this connector. Ensure that the power supplied is suitable for the unit (as marked). If you are in any doubt at all regarding your power supply, consult a qualified electrician.

This section explains how to connect other equipment to the DA-98HR in a variety of situations. It is not intended as a complete reference to the use of the DA-98HR. See the appropriate sections for full details of how these connectors are used.

NOTE

*When making connections between the DA-98HR and other equipment, whether audio or control, both the DA-98HR and the other equipment must be turned **off**, otherwise damage may be caused to the DA-98HR and/or the other equipment.*

Only use TASCAM-supplied and TASCAM-approved cables when making connections to the DA-98HR. Though the cables and connectors may resemble computer cables, they serve different purposes, and meet a different set of specifications. The use of cables other than TASCAM cables will at best cause the equipment to work erratically, and at worst cause damage to the equipment.

If the use of cables other than TASCAM cables causes or results in damage, the warranty is voided.

3.1 Audio connection

Other audio equipment can be connected to the DA-98HR either using optional analog or digital interfaces.

3.1.1 Analog audio connections (optional IF-AN98HR)

All analog audio connections to the DA-98HR are made through 25-pin D-sub connectors to the optional analog slot 2-board set, IF-AN98HR.

This allows convenient and tidy cabling between the DA-98HR and other units such as the TASCAM M-1600 series of mixing consoles.

It is not recommended that you make up your own cables—consult your TASCAM dealer for availability of suitable ready-made cables. However, we recognize that every situation has its own unique features, and there are occasions when a special cable must be made.

Before starting to make the cable, we suggest you contact your TASCAM dealer for full details of cable specifications, etc.

The pinouts for both the **ANALOG OUTPUT** and **INPUT** connectors are given in the manual for these boards, as are detailed specifications and

All audio inputs are balanced and are rated at a nominal +4dBu level.

The impedance of the inputs is 20k Ω and that of the outputs is 10 Ω .

3.1.2 Digital audio connections (using TDIF-1)

TDIF-1 digital audio input and output signals are carried on the same 25-pin D-sub connector ⁵⁶.

To carry signals between a DA-98HR and another DTRS unit or a suitably-equipped digital mixing console, use a PW-88D cable (1 meter long) or a PW-88DL cable (5 meters long).

NOTE

Although the TDIF-1 and AES connectors use the same type of 25-pin D-sub connector, it is not possible to connect a TDIF-1-equipped unit directly to an AES/EBU-equipped unit. An interface such as the IF-AE8HR must be used to convert the signals.

3.1.3 Digital audio connections (using AES/EBU)

The AES/EBU connections (strictly speaking, this format is AES3-1992 Amendment 3-1999) allow direct connections between the DA-98HR and suitably-equipped devices.

NOTE

If four dual-frequency (i.e. 88.2 kHz or 96 kHz) tracks have been selected as the available tracks, see also 7.10.3, “Setting the high-frequency AES/EBU I/O transfer mode”.

The **AES x2 IO** menu item (menu group A), allows the choice of either **dual line** or **high speed** data connections. Note that this menu option is only available when the dual-speed x4 option is selected for the available tracks (see also 6.2.1, “Available tracks”).

3 – Connections—Synchronization connections

In all other cases, the data is transferred according to the following table, where the numbers represent the track which is being transferred. Italicized numerals (e.g. 2) indicate that the signal is being transferred at double speed:

Output channel	4x (2 tracks)	2x (4 tracks)		2x (3 tracks) + base (2 tracks)	2x (2 tracks) + base (4 tracks)	base (8 tracks)
		HS ^a	DL ^b			
1	1	1	1	1	1	1
2	1	2	1	1	1	2
3	—	—	2	2	2	3
4	—	—	2	2	2	4
5	2	3	3	3	3	5
6	2	4	3	3	4	6
7	—	—	4	4	5	7
8	—	—	4	5	6	8

a.High speed
b.Dual line

3.2 Synchronization connections

The DA-98HR is equipped with sophisticated facilities for control and synchronization with other units. For full details of how to operate the DA-98HR with other DTRS units, see 8, “DTRS synchronization”, and for details of timecode synchronization, see 9, “Operations related to timecode”.

3.2.1 Analog timecode connections

The DA-98HR can be synchronized to externally-generated timecode and is also equipped with an internal timecode generator.

The two XLR timecode connectors (47) carry balanced signals with the following polarity:

Pin #	Connection
1	Ground
2	Hot
3	Cold

However, unbalanced signals may be used, with only pins 1 and 2 connected.

	IN (balanced)	OUT (balanced)
Level	0.5 Vp-p to 10.0Vp-p	2Vp-p
Impedance	> 10kΩ	< 100 Ω

The **TIMECODE OUT** connector transmits internally-generated timecode or re-shaped or re-generated timecode echoed from the **TIMECODE IN** connector.

3.2.2 Video connections

These BNC connectors (49) are used to provide video frame reference clocking when the DA-98HR is used with video equipment.

The front panel **CLOCK** switch (45) is used to change between clock sources, and should be set to **VIDEO** when synchronizing to video sync.

Connect the **VIDEO IN** connector of the DA-98HR to the **VIDEO OUT** of a video sync generator unit. This signal should be a 1 Vp-p composite signal.

If other equipment (such as other DTRS units) also need the video frame reference clock, the signal received at the **VIDEO IN** is echoed at the **VIDEO THRU** connector.

If the DA-98HR is the last unit in the chain of video equipment, there is no need to terminate it, as this circuit is self-terminating.

For details of how the DA-98HR can be synchronized to video frame information, see 9.7, “Video resolution”.

3.2.3 Word sync clock connections

This set of BNC connectors (50) is used to synchronize the DA-98HR to other digital audio devices.

The front panel **CLOCK** switch (45) is used to change between clock sources, and should be set to **WORD** when synchronizing to an external word sync clock.

The **IN** jack should be connected to the **WORD SYNC OUT** of the digital audio device from which the DA-98HR is to receive the synchronization clock.

Note the difference between the **OUT** and the **THRU** connectors. **OUT** is used to carry word clock signals generated by the DA-98HR, and **THRU** is used to echo the signals received at **IN**.

If the DA-98HR is the last unit in the word clock chain, there is no need to terminate it, as this circuit is self-terminating.

Also note that if the DA-98HR is connected to other DTRS units using a PW-88S cable as described in 8,

“DTRS synchronization”, the **WORD SYNC** jacks do not need to be connected between the DTRS units.

3.3 Control connections

3.3.1 RS-422 connector

This connector is used to connect the DA-98HR to other controllers or editors which will control the DA-98HR using the Sony P2 protocol, or a bus protocol. See 10, “External control” for details.

If you are in doubt about the compatibility of such a device, please consult TASCAM or your TASCAM dealer, who will be able to advise you.

The DA-98HR can emulate (through software control accessed through menu 6) a number of devices for compatibility with almost any controller.

3.3.2 MIDI connectors (IN , OUT and THRU)

These standard 5-pin DIN MIDI connectors (52) are used to carry MIDI Time Code (MTC) and MIDI Machine Control (MMC) information between the DA-98HR and other suitably-equipped units (for instance, sequencers capable of being synchronized to MTC, and capable of transmitting MMC commands).

The MIDI functions are accessed through menu group 7. See 10.5, “MIDI Machine Control” for full details.

Note the difference between **MIDI OUT** and **MIDI THRU**. The **OUT** connector outputs signals which originate from the DA-98HR. The **THRU** connector echoes messages received at the **IN**.

3.3.3 Parallel control

Parallel control by and of the DA-98HR is performed through the **CONTROL I/O** port (53). See this section for details of how to connect other equipment to this port.

3.4 Connection to other TASCAM units

By a “TASCAM unit”, we mean another DA-98HR, a DA-98, a DA-88 or a DA-38 unit, or an optional remote control unit, or digital mixing console incorporating remote control facilities, which may also be connected in a “chain” with multiple DTRS units.

3.4.1 Multiple DTRS units

Use a TASCAM PW-88S cable when connecting other units to the **REMOTE/SYNC IN** connector (54) or to the **SYNC OUT** connector (55).

This synchronization cable will carry the internal synchronization code and the transport signals, etc. There is no need to make any other connections, apart from the audio connections (either digital or analog).

If more than one DTRS unit is to be used, the first unit in the chain must have its Machine ID set to “1”, (“0” in the case of DA-88s) and subsequent units must have their IDs set in order with no gaps in the numbering sequence. Note that the diagram below does not show any audio connections.

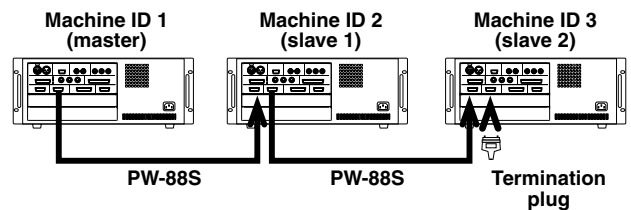

See 8.2.2, “Setting machine ID” for details of setting the Machine ID using menu group 3.

NOTE

*The last unit in the chain must be terminated (a TASCAM termination plug must be plugged into the **SYNC OUT** of the last machine in the chain.*

Once again, only use TASCAM cables for connection of equipment to and from the DA-98HR.

The total length of remote/sync cables in the chain should not exceed 15 m (approximately 50 ft.).

3.4.2 “Indirect” word sync

As mentioned earlier, there is usually no need to use a word clock when connecting DTRS units together. There is, however, a special case when it is necessary to carry external word sync between DTRS units.

This is when a slave DTRS unit is recording digitally from another digital audio device:

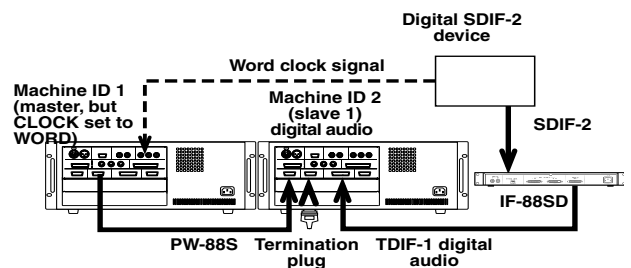

3 – Connections—Connection to other TASCAM units

Though the slave will receive its word clock from the master unit, the master itself must receive its word clock from the other digital audio device.

In this case, the master unit will have its clock source set to **WORD**, and the slave will receive its clock from the master unit through the **SYNC IN** (54).

3.4.3 Meter unit (MU-8824)

The optional MU-8824 external meter bridge unit can be connected using a PW-88M cable from the **METER UNIT** connector (57). You do not need to make any settings on the DA-98HR when connecting the meter unit.

Read this section to understand the basic principles of menu operation. This will help you find your way round the DA-98HR's functions easily and quickly.

4.1 The menus

The DA-98HR has fifteen menu groups, labeled from 0 through 9, and A, B, D, E and F. These are referred to in this manual as “menu group 0”, menu group E”, etc.

The menu which is used to select these menus is called the “top” menu, and looks like this

```

Select Menu Group
▶ 0 1 2 3 4 5 6 7
    8 9 A B . D E F
Dly/InPach/Vari/Loct
    
```

The bottom row of the display is used as a quick reference to remind you of the currently-set value or the contents of the menu group.

4.1.1 Navigation around the menu system

The cursor keys (34) are used to navigate round the screen. In this manual, we sometimes use the following terms for these keys:

CURSOR key	Term used in text
▲	UP key
▼	DOWN key
◀	LEFT key
▶	RIGHT key

Notice that in the top menu, as you move the cursor between menus, the bottom line changes, reflecting the contents of the menu.

4.1.2 Using the ENTER key

From the top menu, when the cursor is beside the desired menu group, press **ENTER** (35) to enter that menu group. The screen changes to show the choices within that group.

These are the choices within menu 0:

```

▶ Delay      Memo 1
  In Patch  Memo 2
  Vari Sed  Loc Pre
    1      0000 Sample
    
```

Use the cursor keys to navigate between menu items within the group. The bottom line of the display changes to show the currently-set values for the parameter beside the cursor.

When the cursor is beside the desired parameter, press the **ENTER** key. You can now change the values of that parameter.

4.1.3 The ESCAPE key

The **ESCAPE** key (36) is used to move up through the menu hierarchy (from menu screens to sub-menus to the top menu). It is therefore used if you enter the wrong menu by mistake.

For a full description of the menu tree, see the Quick Start guide or 11, “Menu and parameter reference”.

4.1.4 Editing values

When a parameter has been selected for editing, the function of the cursor keys is changed.

If there is only one parameter, the ◀ and ▶ keys are not used, and the ▲ and ▼ keys are used to change the value of the parameter. If the parameter is a number, the ▲ key increases the value and the ▼ key decreases the value.

The “cursor” in these menus usually refers to a blinking value on the display, which is the value that can be edited. When we say “move the cursor”, what we are referring to is making a value on the display blink.

If there is more than one parameter or there are “sub-values” to the parameter, such as in the following example for setting the internal timecode generator start time (which is accessed from menu group 8), the procedure is a little different:

```

Generate Start Time
                                30NDF
00:00:00:00
    
```

Here, the internal timecode generator start time can be set. Obviously, we could edit the “frames” field and keep pressing the ▲ key, but one hour would be 30 x 60 x 60 = 10,800 key presses!

To avoid this, the ▶ and ◀ keys move the cursor (as shown by blinking characters) between the “fields”; in this case, hours, minutes, seconds and frames.

Regardless of whether one value or several sub-values have been edited, the changes to the values are made immediately. The cursor keys can then be used for navigation again.

4 – Menu operations—About the function keys

In most time-based menus, when the “frames” field is being edited, the value can be changed from 00 to the number of frames in 1 second (the exact number varies between settings) and back to 00.

However, if the cursor is moved to an invisible “field” to the right of the displayed values, so that the whole of the time value blinks, incrementing the value of the frames field above the number of frames in a second will increment the seconds field.

As an example:

- 1 The menu screen shows: 00:01:43:29 when the frame rate is 30fps.

The 29 indicates that these characters are blinking.

- 2 Press ▲.

- 3 The menu screen shows: 00:01:43:00.

However:

- 1 The menu screen shows 00:01:43:29.

- 2 Press ▲.

- 3 The menu screen shows: 00:01:44:00.
The whole time value has been incremented, not just the frames field.

4.1.5 Resetting a menu value

Sometimes it is necessary to reset a menu value to a default value.

To do this quickly, hold down the ▲ key and press the ▼ key (or hold down the ▼ key and press the ▲ key).

If the menu value is an individual field in a time value, as described, **all** the fields are reset to zero. If the whole time value is flashing, this action also resets the whole of the time value. If there is more than one independent field in a menu screen, use the cursor to point to the value that you want to reset to zero and then perform this action.

4.1.6 Changing menu values fast

Sometimes it is useful to be able to change a value fast (for instance, time values such as minutes and seconds). To do this, hold down the ▲ or ▼ key and press the ENTER key. The values will change faster as long as the ENTER key is held down.

4.1.7 Using the dial to change values

It is also possible to use the dial to change values. This can be a convenient way of making larger changes to numeric values.

- 1 Press the DATA ENTRY key (37) so that the indicator lights.

Note that if the JOG/SHUTTLE indicator (38) is lit (i.e. the dial is being used for jog control), it goes out when the DATA ENTRY key is pressed.

- 2 With the cursor on a data entry field, turn the dial to change the value (clockwise to increment, counterclockwise to decrement).
- 3 When you have finished using the dial as a data entry, you can turn off the DATA ENTRY indicator (press the key once again), or press the JOG/SHUTTLE key so that the dial can be used for jog and shuttle operations.

NOTE

In this manual, we often use the phrase “use the ▲ and ▼ keys to set the value”. In almost all cases, when these keys can be used, the dial can also be used as described above, even when this is not explicitly mentioned.

4.1.8 Blanking the screen display

There are times when you may want to blank the backlit screen display (for instance, the light may be a visual distraction, or you may want to discourage tampering fingers).

- 1 Press the ENTER key, and while holding it down, press ESCAPE (you can also hold down the ESCAPE key and press ENTER).

The screen blanks, and the back light goes out.

- 2 To restore the screen display, press any of the following: ENTER, ESCAPE, or any of the CURSOR keys.

The screen relights, and shows the top menu.

NOTE

This can also be used as an alternative way of returning to the top menu when you are inside the menu hierarchy.

4.2 About the function keys

These keys (15 through 24) may be used as quick-jump keys to commonly-used menus, or can be used as quick location keys.

4.2.1 Function key modes

These keys are often used to jump to frequently-used menus (4.3, “Assigning menus to function keys”), but their function can be changed, as described here:

- 1 Go to menu group 7, move the cursor to FunctMode and press ENTER.

4 – Menu operations—Assigning menus to function keys

- 2 This menu gives you two choices, **Menu**, and **Locate Position**:

```
Function Key Mode
Select

Menu
```

Menu uses the function keys as a quick way of jumping around the menu system (4.3, “Assigning menus to function keys”).

Locate Position assigns the ten function keys to location memories (7.2, “Function key location memories”).

- 3 Select the option with the **▲** and **▼** keys.

NOTE

When you change the function of the “soft” keys between menu and location functions, the values assigned to the other function are not lost, and are restored when you next change the function of the soft keys.

4.2.2 The SHIFT key and function keys

Usually, the 10 function keys and the **LOC 2/PRESET** and **MEMO 2/ +/-** keys perform the duties as marked on the top of their labels (e.g. key ⑩ usually works as the **CLEAR** key).

To use the keys as function keys (whether location keys, or as preset menu keys):

- 1 Press the **SHIFT** key. The **SHIFT** indicator starts to flash.
While it is flashing, these keys are used as described on the bottom row of their labels (e.g. key ⑰ now becomes function key 3 (F3)).
- 2 Pressing a function key in menu mode will turn off the flashing **SHIFT** indicator, but the **SHIFT** indicator continues to flash in location mode after a function key has been pressed.
- 3 If the **SHIFT** indicator is flashing, press the **SHIFT** key again to stop the indicator flashing and return the keys to their original functions of their top printed labels.

4.3 Assigning menus to function keys

It is quite likely that you will find yourself using a few of the same menu functions many times (for instance, manual adjustment of punch points) and

many of the menu functions only rarely (for instance, whether the DA-98HRHR is a master or a slave unit).

The “**F**” keys below the tape counter (⑮ through ⑳) can be used as “soft keys”, providing quick access to the menu screens you use most often.

4.3.1 To assign a menu screen to a key

- 1 Set the function key mode to **Menu** as described in 4.2.1, “Function key modes”
- 2 Use the cursor and **ENTER** keys to display the menu function you want to assign to a key.
- 3 Press the **SHIFT** key ⑳ (the indicator will flash).
- 4 Press the **PRESET** key ㉗. The following will appear on the display. The bottom line shows the menu as selected in step 2.

```
Function Preset
PUSH FUNCTION KEY

Timecode Offset
```

- 5 Press the key (F1 through F10) to which you want to assign the menu screen.

This assigns the menu screen to the key and the **SHIFT** indicator goes out.

4.3.2 Recalling an assigned menu function

- 1 When the function key is set to **Menu** (4.2.1, “Function key modes”), press the **SHIFT** key ⑳ (the indicator flashes).
- 2 Press the **F** key (1 through 10) which has been assigned to the menu function you want to recall.

The menu screen is recalled, and the **SHIFT** indicator goes out.

4.4 Using the function keys as number keys

Press the **10KEY** key ㉖ so that the indicator flashes.

While the indicator is flashing, the function keys are used to enter the digit (**F1** enters a 1, **F2** enters a 2, etc.) except for **F10**, which enters a 0. The **MEMO 2** key ㉕ is used to change the sign of numeric entries where appropriate.

4 – Menu operations—Using the function keys as number keys

If a time value is being entered, and an individual field is blinking (hh, mm, ss, ff, etc.), pressing the **10KEY** key and then entering a numeric value causes the whole time field to be reset and start blinking. Values are added from the right, so that:

Key pressed	Display shows
F1	00:00:00:01
F3	00:00:00:13
F4	00:00:01:34
F7	00:00:17:34

etc.

When you have entered the value (e.g. a location memory) using the function keys as number keys), you should press the **10KEY** key to stop the **10KEY** indicator flashing. Pressing the **ENTER** key will correct any erroneous entries (e.g. a seconds value of 99 will be corrected to 59).

You can use the function keys as number keys in almost any menu where direct numerical input is possible.

You cannot use these keys as number keys when there are only two choices (even if they are numerical). An example of such a menu is the Recharge Mode menu (9.6.10, “Recharging timecode”), where the two options for the Window value are 1 second and 2 seconds. This parameter should be set using the **▲** and **▼** keys, not the number keys.

The following is a step-by-step guide to entering a value (1 minute and 5 seconds) into the Locate Pre-roll parameter (7.1.3, “Setting the location pre-roll time”).

1 Press the 10KEY key so that the indicator flashes.

2 Go to menu group 0, move the cursor to Loc Pre, and press ENTER:

```
Locate Pre-roll
00min00sec
```

3 Press the F1 key (15):

```
Locate Pre-roll
00min01sec
```

The figures on the bottom line of the display start to blink, showing that you are entering numerical data.

Notice that the number is entered from the right of the fields.

4 Press the F10 key (24) (to enter a 0):

```
Locate Pre-roll
00min10sec
```

5 Press the F5 key (19):

```
Locate Pre-roll
01min05sec
```

6 The numbers for this value have now been entered, but the value itself has not. Press the ENTER key (35) to enter the value.

The bottom line of the display stops blinking and the **10KEY** indicator stops flashing.

7 You can also use the ▲ and ▼ keys (or the dial) to adjust the value you have just entered.

NOTE

We strongly advise you to read this section—the effective use of multitrack monitoring is one of the keys to an efficient recording session.

Like all multitrack recorders, the DA-98HR has a number of different monitoring modes, depending on the current monitor status, transport status and whether the track is armed or not.

In addition to the “standard” modes common to most multitrack recorders, the DA-98HR includes two special monitoring features: the **CONFIDENCE MODE** ④, and the individual track **INPUT MONITOR** switches. These are described in this section.

5.1 Monitoring controls

The controls which affect monitoring are:

- **ALL INPUT** ④③
- **INPUT MONITOR** ④①
- **REC FUNCTION** ④⑩
- **CONFIDENCE MODE** ④
- **AUTO MON** ④④

5.1.1 ALL INPUT and INPUT MONITOR

When these are active, the signal from the DA-98HR’s outputs will always be the input source signal received at the input for the appropriate track or tracks.

When the **ALL INPUT** key is pressed, its indicator and the **INPUT MONITOR** indicators of all tracks light. Monitoring for all tracks is then of the input sources.

When the **ALL INPUT** key is pressed again to turn off this mode, the status of the **INPUT MONITOR** indicators will revert to the status before the **ALL INPUT** key was turned on.

The **INPUT MONITOR** switches are disabled until the **ALL INPUT** key is turned off (the **ALL INPUT** indicator goes out).

The **INPUT MONITOR** switches allow you to perform the same function on a track-by-track basis, allowing you to check the input source, and are available from a number of modes as described in the table below.

5.1.2 AUTO MON

When replaying a track, you will usually want to monitor the program material recorded on the tape. However, there are times when you want to monitor

the source input rather than the recorded signal, even in play mode.

The following table shows what will be monitored from a track. This depends on the **AUTO MON** and the **REC FUNCTION** switch settings, and on the transport mode currently engaged.

AUTO MON	REC FUNCTION (track arming)	PLAY	RECORD	STOP, etc.
ON	ON	Tape	Source	Source
ON	OFF	Selectable ^a	Selectable	Selectable
OFF	ON	Selectable	Source ^b	Selectable
OFF	OFF	Selectable	Selectable	Selectable

- a. “Selectable” as used here means that individual tracks’ **INPUT MONITOR** switches can be used to switch between source and tape monitoring. Tape monitoring is obviously only possible when the tape is moving (in recording or play-back modes).
- b. Confidence mode (5.3, “Confidence mode”) is possible in this mode (**AUTO MON** off and **REC FUNCTION** on) and when confidence mode is active, the monitoring is selectable between source and tape.

The **AUTO MON** function therefore allows you to switch automatically between monitoring modes as the tape transport function changes.

NOTE

The **ALL INPUT** key overrides the monitoring mode from the table above (when this mode is active, monitoring for all tracks will always be source monitoring, regardless of the status of **AUTO MON**).

5.1.3 Shuttle monitoring

In addition to these modes, there is one further menu item, that affects monitoring, but only in one special case – shuttle mode. Usually, when shuttling the tape, you will want to monitor the tape. However, if a track is armed, you may want to listen to the source input signal, rather than the recorded signals.

NOTE

ALL INPUT overrides any shuttle monitoring selections described below. Any shuttle monitoring while **ALL INPUT** is on will always be source monitoring.

To turn shuttle monitoring on and off:

5 – Monitoring modes—Patching the outputs

- 1 From menu group 2, move the cursor to **Shtl Mon**, and press **ENTER**:

```
Shuttle Monitor
  
  
  
  
  
  
  
  
  
  
off
```

- 2 Use the **▲** and **▼** keys to change the setting between **on** and **off**.

The shuttle monitoring setting key has no effect when **AUTO MON** is off. While shuttling, you can use tracks' **INPUT MONITOR** switches (regardless of arming status) to change between source and tape monitoring.

When the **AUTO MON** and shuttle monitoring are both on (the indicators will light), the output from all **armed** tracks will be the source input. This cannot be changed.

NOTE

You can always (regardless of any other status except **ALL INPUT**) use the **INPUT MONITOR** switch of unarmed tracks to switch between source and tape monitoring.

If **AUTO MON** is on, but the shuttle monitoring mode is turned off, all armed tracks will monitor the recorded signals in shuttle mode. This cannot be changed.

NOTE

You can also disable shuttle monitoring with the **Shuttle Mute** function (7.6.2, "Shuttle muting").

Shuttle monitoring is attenuated by 12 dB compared with other monitoring modes. This helps to avoid damage to tweeters, etc. when shuttling fast.

5.2 Patching the outputs

The tracks do not have to be assigned to the outputs on a one-to-one basis. This may be useful in situations where a digital audio patchbay is not available.

NOTE

Note that this routing function only allows rerouting between tracks of the same sampling frequency. It is not possible, for instance, to assign a double-frequency track to an output which would normally be used by a base-frequency track.

The outputs are made in parallel on both the AES/EBU and the TDIF-1 outputs (though only one may be selected at a time). If an optional slot board has been installed, the outputs will also be output from there.

- 1 From menu group B, move the cursor to **Out Patch**, and press **ENTER**:

```
Output Patch
  
ch 1 2 3 4 5 6 7 8
Trk▶1 3 2 4 5 6 8 8
```

- 2 Use the **◀** and **▶** keys to select the track (Trk) which will be routed to the output channel. Use the **▲** and **▼** keys to change the value at the cursor.

Note that a track may be routed to more than one channel. In the screen above, the routing is "normalised", except that tracks 2 and 3 are routed to output channels 3 and 2 respectively, and track 8 is paralleled to channels 7 and 8.

When the outputs are not "normalised", i.e. there is no longer a one-to-one correspondence between the tracks and the output channels, the **OUTPUT PATCH** indicator under the tape counter lights.

NOTE

The number of tracks available, and their possible assignments, vary according to the number of available tracks (6.2.1, "Available tracks").

5.3 Confidence mode

When recording in a studio, it is usual to monitor the input signals, rather than the tape. This allows accurate synchronization between studio events and the actions of the control room staff. If a "glitch" is later discovered in the recording, or it is discovered that a signal has been wrongly routed, resulting in an unwanted recording being produced, it is a relatively simple matter to re-record the take.

In a live recording situation, this luxury is not possible. One can hardly ask an orchestra giving a concert to repeat a movement of a symphony for re-recording purposes!

For this reason, the DA-98HR includes a confidence mode which permits off-tape monitoring on a track-by-track basis while recording is in progress.

Confidence mode provides monitoring off-tape while recording for all tracks, except those tracks whose **INPUT MONITOR** switch is active. The monitoring of these tracks will be the input source, not tape.

The actual mechanics of how this is accomplished internally are quite complex, but the result is that off-

tape signals are delayed by about 240 milliseconds relative to the input signal. This means that it is not recommended that you perform punch-ins, etc. in the confidence mode.

In the confidence mode, overdubbing will be out of sync with previously recorded tracks, as well as with the input source.

We suggest you use confidence mode only when laying down long takes of basic tracks which will not need punching for correction (e.g. laying down tracks from a video worktape, or classical live recordings). You may also choose to use confidence mode when you are dubbing from another audio multitrack tape to the DA-98HR, to ensure the quality of the transfer.

Another use for the confidence mode is when you are recording using dither (7.12, “Dither”). You may want to check the effects of dither on the re-quantized recording as the tracks are being laid down.

5.3.1 Arming tracks in pairs

Note that in confidence mode, tracks at the base sampling frequency are always armed and unarmed in pairs (1+2, 3+4, 5+6, 7+8). Dual-frequency and quad-frequency tracks may be armed and unarmed individually.

NOTE

Turning on confidence mode unarms any tracks which have been armed prior to turning on confidence mode.

- 1 Pressing the **REC FUNCTION** of either track 3 or track 4, for instance, will arm both tracks 3 and 4 (provided these are base-frequency tracks).
- 2 Pressing either track 3 or track 4's **REC FUNCTION** key will unarm both tracks (regardless of which track's **REC FUNCTION** key was used to arm the tracks).
- 3 If confidence mode is turned off, track arming and unarming can now be carried out on a track-by-track basis.

Even if tracks were armed in pairs while confidence mode was enabled, when confidence mode is disabled, they can now be unarmed individually.

5.3.2 Using confidence mode

- 1 Adjust the recording levels on all armed tracks.
- 2 Turn off **AUTO MON** mode and make sure that the **ALL INPUT** switch is off.

NOTE

Using confidence mode, it is possible to monitor some tracks off-tape during recording while monitoring the input source of others. However, as explained above, the way in which the confidence mode is implemented means that the off-tape signals are delayed by 240 milliseconds relative to the input source signals. Hence, the off-tape and source signals will be out of sync. We therefore recommend that this function is only used when dubbing.

- 3 Press the **CONFIDENCE MODE** key ④ once. The indicator will flash.

- 4 Press the **CONFIDENCE MODE** key again within five seconds of pressing it for the first time. The indicator will light steadily.

If you do not press the CONFIDENCE MODE key twice within five seconds, the indicator will stop flashing. This is to stop you from entering the confidence mode by accident.

- 5 To leave confidence mode, press the **CONFIDENCE MODE** key once.

5.4 Mixdown patchbay

In addition to the routing, it is also possible to mix down eight signals (as a mixture of off-tape and input signals) to outputs 7 and 8. These outputs are paralleled on the AES/EBU and TDIF-1 digital outputs (though only one of these can be selected at one time) as well as on any optional slot boards fitted to the DA-98HR.

In this way, a rough stereo mix, with channel level and pan, and a master level, can be produced without the need for a mixing console (for example, the AES/EBU outputs can be used to feed a DAT recorder, whose headphone amplifier is then used as the monitoring source).

5.4.1 Turning on the MIXDOWN mode

The mixdown mode is turned on and off using the **MIXDOWN** key ⑳. When this indicator is lit, the mixdown is in operation, and signals will only be received at the 7 and 8 output channels.

NOTE

The mixdown function is only available when all eight tracks have been selected at the base frequency (44.1 kHz or 48 kHz).

*Also note that when the mixdown mode is in operation (i.e. the **MIXDOWN** indicator is lit), the output channels which are not used for the mixdown (1 through 6) are not used.*

5 – Monitoring modes—Mixdown patchbay

5.4.2 Selecting the mixdown sources

- 1 From menu group B, move the cursor to `MixInSel`, and press **ENTER**:

```
Mix Input Select
Trk 1 2 3 4 5 6 7 8
Src ▶ T T T T D S S S
   ch 1 3 2 4 5 6 7 8
```

Here, **T** signifies a tape track, **S** indicates a channel from an optional board fitted in the expansion slot (e.g. the IF-AN98HR) and **D** indicates a digital source (i.e. AES/EBU or TDIF, as currently selected).

The **Trk** line is fixed and cannot be changed, and shows the destination of the source selected using the other two lines. Note that this is not a tape track. The **Src** line indicates the source from which the input is taken, and the **ch** line shows the channel number within the source.

- 2 Use the **▶** and **◀** cursor keys to move the cursor between the different track numbers on the **Src** and **ch** lines of the display.
- 3 Use the **▲** and the **▼** cursor keys to change the values at the cursor.
- 4 To move between the **Src** and **ch** lines, press the **SHIFT** key, and then press the **▲** or **▼** key as appropriate.

If the **MIXDOWN** indicator is active and an invalid source is selected, an appropriate error message is shown and the screen flashes; e.g. `Fs unmatched` for mismatched sampling frequencies, or `TDIF(dubbing) cable not connected`, if a TDIF digital source has been selected, but is not properly connected or switched on. If such an error message appears, press the **ESCAPE** key and correct the settings.

5.4.3 Setting mixdown levels

The output channels' level, pan position (odd-even balance) and the master mix level can all be set using the menu system.

- 1 From menu group B, move the cursor to `Mix Down` and press **ENTER** :

```
Mix Down

ch      Level Pan   Mst
1       127  -0-  127
```

- 2 Select the channel to be adjusted (**ch**), and adjust the level (**Level**) between 0 and 127, and the pan position (**Pan**) between **L--** (hard left) through **Lxx** (the higher the value of **xx**, the further to the left the signal is panned, through **-0-** (center) to **R--** (hard right) via **Rxx** (varying amounts of right pan).

The master (**Mst**) parameter adjusts the master output level for the output mix, and this does not change when another channel is selected for adjustment.

NOTE

*These settings will not be audible until the **MIXDOWN** key is pressed and the indicator is lit.*

This section explains some of the basic operations using the DA-98HR. Section 7, “Advanced operations” describes more advanced operations.

Most operations on a DA-98HR are similar to those on a traditional analog multitrack recorder, but we suggest that you read this section and the next to learn about the features of the DA-98HR.

6.1 Word sync settings

The DA-98HR is capable of accepting word sync clock data from a variety of sources. It is essential that in a digital audio setup, all devices share the same word sync clock, otherwise damage may be caused to monitoring equipment, etc.

The different clock sources available, as shown on the front panel indicators are:

Indicator	Meaning
INT	The DA-98HR acts as a word clock sync master, using its internal clock
WORD	The WORD SYNC IN BNC connector is used as the word clock source
VIDEO	The word clock source is derived from the signal at the VIDEO IN connector
AES/EBU	One of the AES/EBU digital audio sources is used as the word sync clock source
SLOT	If an optional audio interface board has been fitted, this may be used as a word sync clock source

6.1.1 Selecting the word sync clock

- 1 Press the **CLOCK** key  so that the appropriate indicator lights.

NOTE

*In the case of a setup where the DA-98HR is the only digital device in the system (connected to the analog mixing console through the optional IF-AD98HR analog I/O slot boards), you should **not** select the **SLOT** setting (this is for optional digital I/O boards).*

If a selected word sync clock source is not connected or powered up, the clock is out of the permissible range, or is otherwise not available for use, then the indicator will flash, and an appropriate message will be shown on the display.

6.1.2 Setting the AES/EBU channel for the word sync source

When selecting the AES/EBU source for the word sync source, please note the following:

- Even if the AES/EBU digital audio source is not the audio source (6.3.2, “Selecting the digital

source”), the AES/EBU source can still be selected as the word sync clock source using the **CLOCK** key.

- All AES/EBU sources must be at the same frequency, etc. before they can be selected as clock sources. An error message will be shown on screen if they differ.

To view and change the AES/EBU source:

- 1 Go to menu group **A**, and move the cursor to **AesEbuClk**. Press **ENTER**:

```
AES/EBU Clock
      192k 96k 48k
      0    2    4
      ch 2
```

- 2 The current available track settings (6.2.1, “Available tracks” are displayed, and the appropriate signal can be chosen using the **▲** and **▼** keys.

In the case of dual- or quad-frequency tracks being selected and multi-line being selected (3.1.3, “Digital audio connections (using AES/EBU)”), the AES/EBU channels are “bundled” so that one set of channels can act as a clock source.

- 3 Press the **CLOCK** key until the AES/EBU indicator lights

If the selected input is invalid or disconnected, an appropriate message is shown and output signals are muted. Press the **ESCAPE key to reset the error message.**

6.1.3 Clock range with slot board

When the IF-AN98HR optional slot boards are fitted, it is possible to select the internal PLL clock source (and hence the clock range) for these boards.

- 1 Go to menu group **D**, move the cursor to **IoCkRange**, and press **ENTER**:

```
IO Board Clk Range

Narrow
```

- 2 Use the **▲** and **▼** keys to select between **Wide** (an LC oscillator) and **Narrow** (a crystal oscillator) as the PLL clock source for the boards.

6 – Basic Operations—Formatting a tape

NOTE

If *varispeed* is set to on (7.5, “Vari speed (pitch control)”) or *FS shift* is selected (9.4.1, “Pull up and pull down (Fs shift)”), the clock source is set to the same as the *Wide setting* (i.e. the LC oscillator), regardless of what settings are made in this menu.

6.2 Formatting a tape

Before you use a tape in the DA-98HR, you must first format it. This marks internal synchronization patterns for the servo to follow on subsequent passes through the tape as well as the subcode data (ABS). No audio data is normally recorded during a formatting operation (but see below).

When formatting, the tape is prepared for use in HR (high-resolution; 24-bit) or normal mode (16-bit resolution).

The formatting operation also determines the sampling frequency or sampling frequencies that will be used on the tape, and hence, the number of available tracks (see 6.2.1, “Available tracks” below).

While formatting is proceeding, you cannot perform any other transport operation except stopping the tape.

You cannot change the sampling frequencies or the recording resolution while formatting is in progress.

NOTE

Once you have started to format a tape, it is strongly suggested that you allow the format process to continue to the end of the tape. Changing the sampling frequencies, the number of tracks, or the recording resolution in the middle of the tape will almost certainly lead to problems later on. Even if you do not change any of these parameters, but stop and start the tape in the middle of a format process, there will be a discontinuity which will produce unpredictable results if you attempt to record over it.

6.2.1 Available tracks

Because of the way in which the DA-98HR records tracks at sampling frequencies which are different from the base frequency, the number of tracks which are available for recording varies according to the sampling frequency selected.

The **AVAILABLE TRACK** ⑧ indicators above each track meter show the current status of the corresponding track. When the indicator is unlit, the track is not available for use. When red, the track will be recorded at four times the base sampling frequency (quad-frequency), when orange at twice the base

sampling frequency (dual-frequency), and when green, at the base sampling frequency.

The different combinations of available tracks are as follows:

Track							
1	2	3	4	5	6	7	8
4x	4x	—	—	—	—	—	—
2x	2x	2x	2x	—	—	—	—
2x	2x	2x	base	base	—	—	—
2x	2x	base	base	base	base	—	—
base	base	base	base	base	base	base	base

These combinations are selected as explained below in 6.2.2, “The format process”.

Note that all sampling frequencies are related to a base frequency, which may be either 44.1 kHz or 48 kHz. It is not possible to mix sampling frequencies based on different base frequencies on the same tape.

All track combinations other than the eight base-frequency track combination must be in HR (24-bit) mode. It is not possible to make 16-bit dual or quad-frequency recordings using the DA-98HR

NOTE

See 7.10.3, “Setting the high-frequency AES/EBU I/O transfer mode” for details of how to output high-frequency AES/EBU data.

6.2.2 The format process

- 1 Switch on the DA-98HR and load a tape into the tape loading slot ②. As the tape is loaded and threaded, the tape counter shows `--L0Rd--`.

For details of tapes that you can use in the DA-98HR, see 1.5, “Recommended tapes”.

- 2 Press **REW** ⑳ to take the tape to the beginning. When the beginning of the tape is reached, the tape counter shows `bot` (“beginning of tape”).
- 3 Press the **FORMAT/Fs** key ⑦. The indicator starts blinking. Press the **FORMAT/Fs** key again within five seconds. The indicator then lights steadily.

If you do not press the **FORMAT/Fs** key twice within five seconds, the indicator goes out. This is a feature designed to stop you formatting a tape accidentally.

6 – Basic Operations—Recording the first tracks

NOTE

If you do press the **FORMAT/Fs** key twice so that the indicator lights steadily and you then change your mind about formatting the tape, you can use the **STOP** key (31), the **CLEAR** key (16) or the **ESCAPE** key (36) to cancel the operation.

- 4 Use the **HR** key (6) to determine whether recording will take place in **HR** (24-bit) or standard (16-bit) resolution. When the indicator is lit, **HR** mode is selected.
- 5 Select the base sampling frequency either 44.1 kHz or 48 kHz) by pressing the **FORMAT/Fs** key.

The sampling frequency that you select is used as the base frequency of all other frequencies.

The display shows something similar to the following:

```
Format
Select Track fs
176k 88k 44k
0 0 8
```

- 6 Use the **▲** and **▼** keys to change the available track combination.

If **HR** mode is not selected, it is impossible to select any track combination other than the eight base-frequency track combination. If **HR** mode is not selected (the **HR** indicator is not lit) and a combination including dual or quad-frequency tracks is selected, the display shows **Not HR Mode**.

NOTE

If a digital signal is received at either **TDIF-1** input (56) or the **AES/EBU** input (51) and has been selected as a recording source, the **DA-98HR**'s base recording and playback sampling frequency is automatically determined by the sampling frequency of the input signal and you cannot change it.

- 7 To start formatting the tape, hold down the **RECORD** key (33) and press the **PLAY** key (32).

NOTE

The tape counter may show a negative **ABS** time for a short while at the start of the formatting process. While it is displaying a negative value, no audio recording can take place.

- 8 The tape will format to the end, and then rewind automatically, stopping at the **00 00 00 00** position.

You are now able to use the tape for recording.

It is possible to format tapes on a number of **DTRS** units simultaneously. For details, see 8.5.1, "Synchronized formatting".

6.2.3 Aborting the format process

To abort the process before formatting actually takes place (i.e. you have pressed the **FORMAT/Fs** key twice in error), press the **STOP** key (31). The **FORMAT** indicator will go out.

As explained earlier, the only transport operation you can perform once formatting has started is to stop the tape.

However, we do not recommend interrupting the formatting process, but strongly suggest that you let the tape run to the end. If you interrupt the formatting (or the formatting is interrupted by a power cut or events beyond your control), rewind the tape and start the format from the beginning of the tape again.

6.2.4 Recording while formatting

If you have armed any tracks (you have pressed the appropriate **REC FUNCTION** key(s) (40) and the indicator is flashing), any audio signal routed to that track will be recorded while formatting is in progress.

NOTE

If you have recorded and formatted part of a tape, and you will continue formatting and recording on the rest of the tape ("assembly"), you should rewind to a pre-formatted, blank section of the tape and resume formatting and recording from there.

Recording and formatting will continue at the sampling frequency used on the first part of the tape.

Avoid re-starting recording and formatting from an unformatted section of the tape.

6.3 Recording the first tracks

There are a number of different ways of recording the first tracks. However, all follow the same basic principles.

NOTE

When using a newly-formatted tape, we suggest that you record a blank "leader" about 30 seconds long, starting from the beginning of the tape, to avoid dropout. Leave a similar recorded blank "trailer" at the end of the recording. You can use the **Rec Mute** function as a convenient way of recording silence (see 7.11, "**REC MUTE** (recording silence)").

6 – Basic Operations—Recording the first tracks

If the tape counter shows a negative value, you cannot record on the tape at that position.

6.3.1 Preparing to record

- 1 If you have not already loaded a formatted blank tape, do so now.
- 2 Make sure that varispeed is turned off (check the **VARI SPEED** indicator ⑩ and use the menu item (see 7.5, “Vari speed (pitch control)”) to turn it off if necessary).

6.3.2 Selecting the digital source

The DA-98HR has two built-in digital input sources: for AES/EBU and TDIF-1 format data. Each of these connectors can accept and output eight channels of base-frequency audio. Either of these inputs can be selected:

- 1 Use the **AES/EBU** key ⑬ to select between the **TDIF-1** and the **AES/EBU** inputs and outputs. If the indicator is lit, the **AES/EBU** connector ⑤① will be used, otherwise the **TDIF-1** connector ⑤⑥ will be active.

Note that this only selects the source—digital signals are always output from both the TDIF-1 and the AES/EBU connectors.

6.3.3 Selecting input sources

The DA-98HR contains a flexible input patchbay, which allows signal sources to be selected between digital, analog (if the optional IF-AN98HR slot board set has been installed), recorded tracks on the tape (for track bouncing), and muting.

- 1 Press the **INPUT PATCH** key ⑫ so that the indicator a screen similar to the example below appears (this assumes that all eight tracks are available for recording at the base frequency):

Input	Patch							
Trk	1	2	3	4	5	6	7	8
Src	T	M	S	S	D	M	S	S
ch	1	-	3	4	5	-	8	8

Alternatively, select menu group 1, move the cursor to **In Patch**, and press **ENTER**.

In this screen above, the **Src** line shows the possible signal sources: **T** for tape, **S** for an optional slot input card, **D** for digital and **M** for mute. The **ch** line indicates the input channels available from these sources (except for the mute setting, which naturally does not have

any sources, and therefore is always represented by a **-**).

- 2 Use the **◀** and **▶** keys to move the cursor along a line.
- 3 Use the **▲** and **▼** keys to change the parameter value.
- 4 To move between lines, press the **SHIFT** key, and then press the **▲** or **▼** key as appropriate.

Pressing the **▲** or **▼** keys together will normalize the settings so that there is a one-to-one correspondence between slot channels and tape tracks.

With a digital recorder such as the DA-98HR, track crosstalk is almost negligible (better than 90dB at 1kHz). For this reason, you do not have to worry so much about the constraints of choosing physical track locations as you do with analog recordings.

Note that this function can also be used for track copying later in the recording process. Remember that track copying in the digital domain will add no noise or distortion. A digital copy is a “clone” of the original, and no loss of quality is incurred.

6.3.4 Write-protecting cassettes

If you attempt to record on a cassette where the write-protect tab has been closed, an error message will appear on the screen as you press the **RECORD** key. Recording is, of course, not possible on a write-protected cassette.

Hi8 cassette write tabs work in the opposite manner to DAT cassettes, and “closed” means “write-protect”.

If the tape is write-protected, the **REC INHI** indicator to the left of the tape counter will be lit. Eject the tape, open the write-protect tab, replace the cassette, and try again.

NOTE

Sony Hi8 cassettes (and those from some other manufacturers) have the words “SAVE” (write-protected) and “REC” (write-enabled) molded into the cassette shell by the protection tab.

6.3.5 Recording the basic tracks (i)

- 1 Arm the tracks on which you wish to record by pressing the **REC FUNCTION** key of these tracks; the indicator starts flashing. Remember that you can only arm those tracks whose **AVAILABLE TRACK** indicators are lit.

- 2 Adjust the input signal levels so that the track meters read high, but the **OVER** segment does not light.

NOTE

Use the reference level you have chosen (7.7, “Reference levels”) to be your “nominal” level.

- 3 Hold down the **RECORD** key, and press the **PLAY** key. The tape starts to move and recording starts.

The **REC FUNCTION** indicators of all tracks light steadily.

When you start recording, the point at which recording starts is automatically stored into memory for punch-in purposes.

- 4 To stop recording and stop the tape, press the **STOP** key. You can also press the **PLAY** key, which will continue the tape movement, but stop recording.

6.3.6 Recording the basic tracks (ii)

This is an alternative method of recording basic tracks on a blank, formatted tape.

- 1 Arm the tracks and adjust the levels as described in [1] and [2] above (6.3.5, “Recording the basic tracks (i)”).

The **REC FUNCTION** indicators of all armed tracks flash.

- 2 Press the **PLAY** key. The tape starts to move.
- 3 When you reach the point at which you want to start recording, press the **RECORD** key.

The **REC FUNCTION** indicators of all armed tracks will light steadily.

The point at which recording starts is automatically stored into memory for punch-in purposes.

- 4 Stop recording as described above.

6.3.7 Replaying the first tracks

When you have positioned the tape at the beginning of the recording you have just made (or at the pre-roll point), you can start playing back the tape.

- 1 Turn off the **RECORD FUNCTION** key of the track you have just recorded.

Though it is not strictly necessary, we suggest turning off the **RECORD FUNCTION** on all armed tracks (or using the **ALL SAFE** key ④2). This will prevent you from accidentally hitting

the **RECORD** key and going into record mode, overwriting what you have already recorded.

- 2 Make sure that the **INPUT MONITOR** of the track you have just recorded is turned off (5.1.1, “**ALL INPUT** and **INPUT MONITOR**”).

- 3 Rewind the tape to the point that you started recording (use the **PREROLL** key to find this position easily, as the point at which recording started is automatically stored) and press **PLAY**.

If the **AUTO PLAY** indicator ⑱ is lit, playback will automatically start when the location point is reached.

6.4 Overdubbing

Overdubbing subsequent tracks is carried out in a very similar way to recording the first tracks.

If you are unsure about the difference between monitoring modes as implemented on the DA-98HR, now is a good time to read the section 5, “Monitoring modes”.

Obviously you will want to record while you listen to the signals from previously-recorded tracks and the input source on tracks where recording is taking place.

Note, however, that the use of confidence mode when overdubbing (5.3, “Confidence mode”) is not recommended, as the off-tape replay signals will be delayed, making it impossible to provide accurate cues.

6.5 Track bouncing

Though the DA-98HR provides a method of copying from track to track digitally (6.3.3, “Selecting input sources”), there is no way of combining tracks within the DA-98HR.

If you need to combine tracks, this must be done through an external console, routing all tracks to be combined through an output group, and routing that group to the appropriate track input.

6.6 Punch-in and punch-out

There are a number of ways in which the DA-98HR can be used to perform reliable punch-in and punch-outs automatically. Punch points can be set and

6 – Basic Operations—Punch-in and punch-out

edited to sample accuracy, either from a list of numerical values or “on-the-fly” in real time.

The DA-98HR provides a rehearsal mode which simulates the punching process, allowing the artists to perfect the timing of the new material.

The mechanics of punching on a digital recorder appear to the operator to be the same as on an analog recorder.

Crossfading, however, is an important and useful function on digital recorders, to ensure continuity between original and punched material. In the case of the DA-98HR, this crossfade time is adjustable from 10 milliseconds to 200 milliseconds (7.4, “Crossfade time”).

The **AUTO MON** mode is essential here: in both rehearsal and punch modes, the material prior to the punch point is monitored from the tape. The monitoring of armed tracks changes to source while rehearsals and punching are carried out and then changes to monitoring the tape again after the punch-out point.

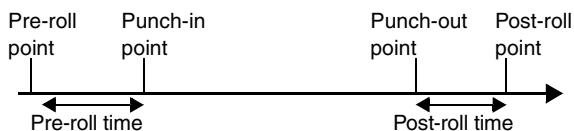

Rehearsal learn		
TAPE	SOURCE	TAPE
Rehearsal		
TAPE	SOURCE	TAPE
AUTO PUNCH		
TAPE	SOURCE	TAPE
Replay check		
TAPE	TAPE	TAPE

6.6.1 Overview of punch procedures

A typical way in which a punch is performed (this is all explained in more detail later in this section) is:

- 1 Press the **AUTO MON** key (44) to enable automatic monitor switching (see 5, “Monitoring modes”).
- 2 Press the **RHSL** key (21) to put the unit into “rehearsal learn” mode and set the punch points using the **RECORD** and **PLAY** keys. Fine-tune the punch points if necessary using the menu system (6.6.4, “Setting and editing punch points using the menus”).
- 3 Press the **RHSL** key again to start rehearsing the punch. When **PLAY** is pressed, the unit drops into simulated record mode at the punch in point and out again at the punch-out point. It also automatically rewinds to an appropriate

pre-roll point following the punch-out. No new material is recorded at this stage (6.6.6, “Rehearsing the punch-in”).

- 4 When ready for the take, press the **AUTO PUNCH** key (22) so that the indicator flashes. Now when **PLAY** is pressed, the unit records at the punch-in point and drops out at the punch-out point (6.6.8, “Recording the punch-in”).
- 5 To replay and check the punch, press **PLAY** to play back the original and the punched material (6.6.9, “Reviewing the punched material”). The **AUTO PUNCH** indicator is now steadily lit.
- 6 Press **AUTO PUNCH** (flashing indicator) again to re-record the punch, or unarm the track(s) and press **CLEAR** (16) to exit the punch mode.

NOTE

Although it is theoretically possible to perform punch recording in either the confidence mode (5.3, “Confidence mode”) or the **ALL INPUT** mode (5.1.1, “**ALL INPUT** and **INPUT MONITOR**”), the monitoring in these modes does not make it easy to perform accurate punch operations. We suggest that you turn these modes off if you want to perform punch operations.

6.6.2 Automatic punch point setting

Whenever recording takes place, the time when recording begins is automatically stored as a punch-in time, and the time when recording stops (when either the **STOP** or the **PLAY** key is pressed) is stored as a punch-out time.

There are other ways in which you can set these points, as described below:

6.6.3 Setting punch points “on the fly”

This method demands sharp reflexes (but you can edit the punch points later as we show below).

- 1 Press the **AUTO MON** key (44) (the indicator lights).
- 2 Arm the track(s) on which you will be recording (use the **REC FUNCTION** keys). The **INPUT MONITOR** indicator(s) of any armed track(s) light and monitoring changes to input source recording for these tracks.
- 3 Press the **RHSL** (rehearsal) key (21).
The indicator flashes, showing that the DA-98HR is in “rehearsal learn” mode.
- 4 Rewind the tape to before where the punch is to occur.

6 – Basic Operations—Punch-in and punch-out

- 5 Start playing the tape (press **PLAY**), and the signals from tape will be monitored.
- 6 At the point where the punch is to occur, press **RECORD**.

The **RECORD** key flashes, and the **REC FUNCTION** indicator(s) of any armed track(s) light steadily.

At any time when the rehearsal key is lit or flashing, this means that recording will not actually be carried out, even if the **RECORD** key and/or the **REC FUNCTION** indicators are lit.

- 7 At the point where you want to punch out, press **PLAY**.

The **REC FUNCTION** indicator(s) of any armed track(s) starts flashing again. The **RECORD** key goes out.

- 8 After the post-roll period, the tape returns to the pre-roll point (the punch-in point minus the pre-roll offset).

The **RHSL** indicator now lights steadily, showing that the DA-98HR is in rehearsal mode.

NOTE

If you want to alter the pre-roll and post-roll times, see 6.6.5, "Editing the preroll and postroll times". The punch-in and punch-out points will remain the same while you change the pre- and post-roll times.

6.6.4 Setting and editing punch points using the menus

- 1 Press the **RHSL** (rehearsal) key $\text{\textcircled{21}}$ twice (or until the indicator lights steadily).
- 2 Press the **AUTO MON** key $\text{\textcircled{44}}$ (the indicator will light).
- 3 Go to menu group 1 and select the **In Point** option using the cursor keys and **ENTER**:

```
Punch-in Point
  Sample Sub frame
                                29DF
00:09:21:12.0000 sm
```

In the screen above, the sub-frame units are samples. Select the sub-frame units, which can either be 1/100 of a frame, or samples, by moving the cursor to the right field (here it is $\text{\textcircled{m}}$, but for 1/100 frame units it is $\text{\textcircled{f}}$) on the bot-

tom line of the display, and using the \blacktriangle and \blacktriangledown keys to change between them.

- 4 Use the \blacktriangleright and \blacktriangleleft keys to select the "field" (hours, minutes, seconds or sub-frame units) that you want to edit, and use the \blacktriangle and \blacktriangledown keys to change the values. The function keys can also be used as number keys (4.4, "Using the function keys as number keys").
- 5 Press **ESCAPE** to return to menu group 1.
- 6 Select **Out Point** and repeat the process for the punch-out point.

NOTE

You can also use this process to edit punch points which have been set "on the fly".

- 7 Locate the tape to the punch-in point (minus the pre-roll time) by pressing **LOC 1** $\text{\textcircled{24}}$.

6.6.5 Editing the preroll and postroll times

As shipped from the factory, the DA-98HR will position the tape 5 seconds before the punch-in point, whether this has been set by you, or set automatically (as described above).

The post-roll is factory set to 3 seconds. You can alter both these times using the following method:

- 1 Enter menu group 1, move the cursor to the **Pre/Post** menu option, and press **ENTER**:

```
Pre-roll Post-roll
Pre          Post
00m05s      00m10s
```

- 2 Use the \blacktriangleleft and \blacktriangleright keys to position the cursor by the "field" (minutes or seconds) that you want to change and use the \blacktriangle and \blacktriangledown keys to alter the value.

You can also use the function keys to enter the value directly, as described in 4.4, "Using the function keys as number keys".

Since there is little point in setting pre- and postroll times to frame accuracy, you can only set these values to second accuracy.

The minimum value you can set for preroll is 5 seconds and the maximum value is 59 minutes 59 seconds.

6 – Basic Operations—Punch-in and punch-out

Any punch operation from now will take your setting for pre-roll and use it when locating the tape to the punch-in point. For example, if your preroll time has been set to 10 seconds (00:00:10:00), and the punch-in point is at 00:06:03:12, the tape will locate to 00 05 53 12 when starting rehearsal or punch-in.

- 3 **Postroll is set in the same way. Use the ◀ and ▶ keys until the cursor is by the Post field, and repeat the steps above.**

The minimum value for postroll is 3 seconds.

6.6.6 Rehearsing the punch-in

After you have set the punch points, and you have located the tape to the pre-roll point, as described above, you can rehearse the punch process.

- 1 **Press the RHSL key (21) so that the indicator lights steadily, indicating that you are now in rehearsal mode.**
- 2 **Press PLAY. The tape starts playing from the pre-roll point.**
- 3 **At the punch-in point, monitoring changes to source.**

The RECORD key flashes, and the REC FUNCTION indicator of any armed tracks lights steadily. However, recording is not carried out.

- 4 **At the punch-out point, monitoring changes back to tape monitoring.**

The tape continues playing to the post-roll point and then rewinds to the pre-roll point.

NOTE

If the AUTO PLAY mode is active (press the AUTO PLAY key (18) so that the indicator lights), playback starts again as soon as the pre-roll point is reached.

- 5 **Repeat the rehearsal process until you are satisfied with the performance.**

6.6.7 Interrupting a rehearsal or punch recording

Very often while rehearsing a punch-in, you will not want to run the tape all the way to the punch-out point (an entry is missed, or a mistake is made early

on in the take). In these cases, the following procedure applies to both rehearsal and punch recording:

- 1 **While the tape is running, press the PREROLL key (17). There is no need to press STOP first.**

The tape returns to the punch-in point, minus the value specified in the punch-in offset (6.6.5, “Editing the preroll and postroll times”).

NOTE

The location pre-roll time (7.1.3, “Setting the location pre-roll time”) is not used here.

- 2 **Pressing PLAY re-starts the rehearsal or punch-in process.**

6.6.8 Recording the punch-in

- 1 **Make sure the tape is at the pre-roll point, and press the AUTO PUNCH key (22) once.**

The indicator flashes, showing that the DA-98HR is in auto-punch mode.

- 2 **Press PLAY. The tape starts playing.**

At the punch-in point, the RECORD indicator lights steadily, as do the REC FUNCTION indicators of any armed tracks. Monitoring changes from off-tape to source and the INPUT MONITOR of any armed tracks light.

Actual recording now takes place. Any recorded material which was previously on the armed tracks between the punch points is replaced by the new recording.

- 3 **At the punch-out point, the monitoring returns to tape monitoring (the INPUT MONITOR indicators of armed tracks go out), and when the post-roll point is reached, the tape rewinds to the pre-roll point.**

NOTE

If the AUTO PLAY mode is active (press the AUTO PLAY key (18) so that the indicator lights), playback starts again as soon as the pre-roll point is reached.

- 4 **The AUTO PUNCH indicator lights steadily, showing that the DA-98HR is now in “review” mode.**

6.6.9 Reviewing the punched material

- 1 To replay the punch-in, press the **PLAY** key.
Playback start (the **REC FUNCTION** indicators of the armed tracks will continue to flash).
- 2 At the post-roll point, the tape automatically rewinds to the pre-roll point.
- 3 If you want to record the punch-in again, press the **AUTO PUNCH** key (22) so that the indicator flashes, and repeat the process described above.
- 4 If you are satisfied with the punch-in, follow the steps below, otherwise, press **LOC 1** to return to the punch-in point, press the **AUTO PUNCH** key so that the indicator flashes, and repeat the take.

6.6.10 Exiting punch-in mode

- 1 Disarm any armed tracks (press the **REC FUNCTION** keys so that the indicators go out).
- 2 Press the **CLEAR** key (16) to exit the **AUTO PUNCH** (or rehearsal) mode.

The punch points are still retained in memory.

- 3 You can press the **AUTO MON** key so that the indicator goes out and normal monitoring modes are now in effect (5, “Monitoring modes”). However, leaving the unit in **AUTO MONITOR** mode may be more useful while recording.

7 – Advanced operations

7.1 Autolocation

The DA-98HR contains two location memories accessible through the **LOC 1** and **LOC 2** keys (Ⓐ and Ⓑ). These also provide a “A↔B repeat” facility, which allows you to rehearse part of a mixdown, for instance (see 7.2.5, “Repeat function”). These two location memory points are referred to as “MEMO 1” and “MEMO 2”.

In addition to these two location memories, the DA-98HR can also store 10 more location memories, which are accessed through the function keys (Ⓔ through Ⓓ).

As with the punch recording points (6.6, “Punch-in and punch-out”), it is possible to set and edit these points in a number of ways.

7.1.1 Setting MEMO 1 and MEMO 2 “on the fly”

This can be done regardless of the current status of the tape transport (playing, recording, winding, stopped, or shuttle).

- 1 Press the **MEMO 1** or **MEMO 2** key: Ⓘ or Ⓢ.

The current tape position will be stored to the appropriate location memory (**MEMO 1** or **MEMO 2**).

The display screen will indicate that the location memory point has been stored.

```
Position saved in
location memory

10:03:12:24   ABS
```

7.1.2 Checking, editing and manually entering MEMO 1 and MEMO 2

The checking, editing, and manual entry of the **MEMO 1** and **MEMO 2** location points are all essentially the same operation. Location points can be edited and entered to frame accuracy.

- 1 Go to menu group 0:

```
Delay   ▶Memo 1
In Patch Memo 2
Vari Spd Loc Pre
00:04:12:12   29DF
```

If you are only checking the location points, you can see the value of the location point on

the bottom line of the display screen. As you move the cursor between **Memo 1** and **Memo 2**, the value shown will change appropriately. Press **ESCAPE** when you have finished checking.

- 2 To edit the points, move the cursor to **Memo 1** or **Memo 2** and press **ENTER** to select the location point to edit.

```
Memo 1

00:04:12:12   29DF
```

- 3 Use the **▶** and **◀** keys to select the field you wish to edit (hours, minutes, seconds or frames) and the **▲** and **▼** keys to change the value, or you can edit the whole time value together (4.1.4, “Editing values”).

You can also use the function keys to enter the value directly, as described in 4.4, “Using the function keys as number keys”, or the dial to adjust the values (4.1.7, “Using the dial to change values”).

7.1.3 Setting the location pre-roll time

When you locate to a location memory (whether it is one of the **MEMO 1** and **2** points or the 10 “function key” memories), the tape will stop at the memorized location point, minus a pre-defined pre-roll time.

As shipped, the DA-98HR’s default location pre-roll time is 0 seconds. You can edit this to a value between 0 seconds (the tape will locate to the exact location point) and 59 minutes, 59 seconds, in 1 second increments.

NOTE

This pre-roll time is independent of the punch pre-roll time (6.6.5, “Editing the preroll and postroll times”).

- 1 Go to menu group 0, move the cursor to **Loc Pre**, and press **ENTER**.

```
Locate Pre-roll

00min06sec
```

- 2 Use the **◀** and **▶** keys to select the field you wish to edit (minutes or seconds) and the **▲** and **▼** keys to change the value.

You can also use the function keys to enter the value directly, as described in 4.4, “Using the

7 – Advanced operations—Function key location memories

function keys as number keys” or the dial to change values (4.1.7, “Using the dial to change values”).

When you go to a location point, the tape will now locate to the location point, minus the value you have just entered. For instance, if the location point is at 00:12:04:03 and you have set a location pre-roll time of 5 seconds, the tape will locate to 00 11 59 03.

7.1.4 Locating to MEMO 1 and MEMO 2

When you have set the location memories as described above, you simply need to press the **LOC 1** or **LOC 2** keys (24) or (27) to move the tape to these location points.

The display briefly shows the location memory value and the pre-roll time.

```
Locate      Preroll
Point       Time
00:02:23:08  00m03s
```

The tape then locates to the location memory minus the location pre-roll time, as described above.

7.2 Function key location memories

As explained in 4.2.1, “Function key modes”, the ten “soft” function keys can be assigned to locate to memorized positions.

7.2.1 Storing a function key location memory

In addition to the MEMO 1 and MEMO 2 memories, the function keys can store location memories.

The function keys must be in “location memory” mode (4.2.1, “Function key modes”, set in menu group 7).

The tape transport can be in any function (play, record, stop, shuttle) when you store a memory and assign it to a function key.

- 1 Press the **SHIFT** key (28), so that the indicator flashes.

- 2 Press the **LOC 2/PRESET** key (27):

```
Function Preset
PUSH FUNCTION KEY
Locate Position
```

- 3 Press the function key to which you want to assign a memory. The display screen shows the time of the location memory after you have stored it to a function key.

You can continue to press function keys to add location memory points. If you are recording a song, for example, you could run the tape from the beginning of the song and use the function key memories to mark the beginning of verses, choruses, instrumental breaks, etc. In post-production work, you could use this feature to mark important points in the video soundtrack.

- 4 To use the function keys for their preset functions as written on the front panel, press **SHIFT** (28) again so that the **SHIFT** indicator goes out.

7.2.2 Editing function key memories

Function key memories can be edited in the same way as the MEMO 1 and MEMO 2 memories.

- 1 Go to menu group 7, move the cursor to **Loc (Func)**, and press **ENTER**:

```
Locate Position
(Function Key)
29DF
F. 1 00:04:23:15
```

- 2 Move the cursor to the function key number, and use the **▲** and **▼** keys to select the number of the function key memory that you want to change.
- 3 Use the **◀** and **▶** keys to select the field (hours, minutes, seconds or frames) and use the **▲** and **▼** keys to change the value of the field.

7.2.3 Locating to a function key memory

Once a location has been assigned to a function key, this is the procedure for location to the memory position:

- 1 With the function keys in “location memory” mode(4.2.1, “Function key modes”, set in menu

7 – Advanced operations—Track delay

group 7), press the **SHIFT** key (28), so that the **SHIFT** indicator flashes.

- 2 Press the function key corresponding to the memory to which you want to locate.

The display shows the location point and the pre-roll time, and the tape starts to locate to the appropriate location memory.

- 3 To use the function keys for their preset functions as written on the front panel, press **SHIFT** again so that the **SHIFT** indicator goes out.

7.2.4 Location and playback

If you press the **PLAY** key while the tape is locating (the **PLAY** key flashes), the tape starts playing when it reaches the location point.

If you press **PLAY** twice while the tape is locating, the **PLAY** key lights steadily, the tape stops and playback starts immediately.

If you have pressed the **AUTO PLAY** key (18) before pressing the **SHIFT** key in step 1 in 7.2.3, “Locating to a function key memory”, (the **AUTO PLAY** indicator is on), replay will start automatically when the location point is reached.

7.2.5 Repeat function

You can repeat playback continuously between the two location memory points (Memo 1 and Memo 2).

NOTE

When we talk about the “first” and the “second” locations here, we are referring to the earlier and later location times. Memo 1 could be at a later time than Memo 2, and hence we refer to it in this section as the “second location point”.

In repeat mode, the tape winds to a little before the first point (if it is not there already) and starts playing. Repeat playback (and hence tape monitoring) starts at the first memory location and continues until the second location is reached. The tape then stops playing, and rewinds to a little before the first point and starts playing again.

7.2.6 To start repeat play

- 1 When the two location points have been set, press the **REPEAT** key (23).
- 2 The tape locates to the first location point and starts playing until the second location point,

rewinds to the first location point, and plays again. This process is repeated.

While the tape position is between the two location points, the **REPEAT** indicator lights steadily. It flashes while the tape position is outside the two location points.

- 3 Stop the repeat function by pressing the **REPEAT** key so that the indicator goes out.

If the tape is playing at this time, it will continue playing (past the second location point).

If the tape is rewinding to the first location point when the **REPEAT** key is pressed, it will stop.

NOTE

The two location points must be at least 5 seconds apart for the repeat facility to be operational.

If you have only set one location point, the repeat will be between 00 00 00 00 and the location point.

Pressing any transport control while repeat play is in progress will stop the replay, but will not cancel the repeat mode. To restart the repeat playback, locate to either location point, and while the tape is winding, press **PLAY**. Alternatively, press **PLAY** while the tape is before the second location point.

7.3 Track delay

The DA-98HR allows you to delay tracks relative to the other tracks, either when recording or playing back. You can use this function for post-production “slip”, compensate for delays caused by external processing equipment, allow for propagation delay in multi-microphone sessions or add special effects.

The track delay can be set from –200 samples to +7200 samples. A negative number means that the track on which the “delay” setting is made is advanced in time relative to the other tracks. However, this does not mean that the DA-98HR includes a time machine! Since the monitoring head is a “virtual” head, made of a composite of input source signals and delayed signals from tape, the “position” of the recording head can be adjusted in both directions.

The track delay, expressed in seconds, is between –4 to +150 milliseconds. At a typical sound propagation rate, the maximum value corresponds to about 50 meters (about 160 feet) of distance.

7.3.1 To set the track delay:

- 1 Select menu group 0, and move the cursor to `Delay`. Press the **ENTER** key:

```
Track Delay Time

Track
1      0000 sample
```

- 2 To select the track whose delay time you want to change, move the cursor to the number at the bottom left of the screen and use the **▲** and **▼** keys to select the track.

By using the **10KEY** key (4.4, “Using the function keys as number keys”), you can use the function keys to select the tracks directly. Function keys which do not correspond to an available track will be ignored, as will **F10**.

You can select all the available tracks (depending on the current track availability—6.2.1, “Available tracks”) or **ALL** (**ALL** can be selected using function key **F9** 24).

NOTE

If the **ALL** setting is made when the individual track delay settings are not identical, the value shown will be `-----`. Adjusting the value using the cursor keys or function keys will change this to the correct numerical value.

- 3 By moving the cursor to the bottom right parameter (shown here as “`Sample`”), and using the **▲** and **▼** keys, you can display and set the track delay in either samples or milliseconds (`msec`).

NOTE

`Sample` always refers to the actual frequency at which the selected track is being recorded. At high sampling frequencies, one sample is a shorter time than at lower sampling frequencies.

- 4 Move the cursor to the central number. The **▲** and **▼** keys will change the delay value for the selected track(s).

Remember that you can reset the value to zero by pressing and holding the **▲** key and then pressing the **▼** key. If “**ALL**” has been selected for the track, then all track delays will be reset to zero.

You can also use the function keys to enter the value directly, as described in 4.4, “Using the function keys as number keys”.

The **DELAY** status indicator by the tape counter ⑩ lights when any track’s delay value is set to a non-zero value.

7.4 Crossfade time

As mentioned earlier (6.6, “Punch-in and punch-out”), digital punch recording requires that the original and new signal be crossfaded over a short period of time.

The factory default crossfade time for the DA-98HR is 10 ms, and this can be adjusted in 10 millisecond steps to a maximum of 200 ms.

For the most part, 10ms is an adequate value and will produce seamless punches, but there may be times (matching reverb settings, etc.) when a longer crossfade is required.

- 1 Select menu group 1, move the cursor to **X-Fade** and press **ENTER**.

```
Crossfade Time

10 ms
```

- 2 Use the **▲** and **▼** keys to adjust the crossfade time. You can also use the function keys to enter the value directly, as described in 4.4, “Using the function keys as number keys”.

7.5 Vari speed (pitch control)

The speed of recording and playback (and hence the pitch) of the DA-98HR can be adjusted to 6% above or below normal speed in 0.1% steps.

NOTE

You cannot operate the pitch control when the DA-98HR is slaved to another unit, or synchronized to an external word sync clock (3.2.3, “Word sync clock connections”) or to a video clock (3.2.2, “Video connections”).

7.5.1 To set a non-standard speed

- 1 Select menu group 0, move the cursor to `Vari Spd`, and press **ENTER**:

```
Vari Speed

Fix + 0.0%
```

7 – Advanced operations—Shuttle operations

- 2 Use the ◀ and ▶ keys to move the cursor to the left parameter (Vari or Fix).
- 3 Use the ▲ and ▼ keys to select Vari rather than Fix, and the VARI SPEED indicator by the tape counter ⑩ will light.
- 4 Move the cursor to the value setting and use the ▲ and ▼ keys to alter the speed in 0.1% steps.

NOTE

The VARI SPEED indicator by the tape counter will light whenever the setting is Vari, even if the speed is set to 0.0%.

If pull up or pull down (Fs shift) is enabled (9.4.1, “Pull up and pull down (Fs shift)”, vari speed cannot be enabled.

Playback and recording now take place at the new speed which has just been set.

7.5.2 Resetting the speed to standard

- 1 Select menu group 0, move the cursor to Vari Spd, and press ENTER:

```
Vari Speed
          Vari + 1.4%
```

- 2 Move the cursor to the Vari field.
- 3 Use the ▲ and ▼ keys to change Vari to Fix, and the VARI SPEED indicator by the tape counter ⑩ goes out.

NOTE

Remember that the VARI SPEED indicator reflects the status of the Vari/Fix parameter, not the value of the variable speed. If the speed is set to a value other than 0.0%, and the status is Fix, the speed will remain at the standard value until Fix is changed to Vari.

7.6 Shuttle operations

The JOG/SHUTTLE key and indicator ③⑧ and shuttle wheel/jog dial control ③⑨ are used to simulate the “rock and roll” location method on open-reel tape decks, allowing you to locate a point on tape through audible cues.

As the knob is moved from the center detented position, the shuttle speed becomes higher.

The variation in speed is not continuous; but as you turn the knob from the center position, the shuttle

speed changes, following these values (relative to normal speed): 0.25, 0.5, 1.0, 2.0, 4.0, 8.0. The 1.0 speed is only available when shuttling in the forward direction.

Shuttle operations are only possible when the JOG/SHUTTLE indicator is lit by pressing the JOG/SHUTTLE key. While shuttling is active, none of the transport keys are lit.

If the DATA ENTRY indicator ③⑦ is lit when the JOG/SHUTTLE key is pressed, the DATA ENTRY indicator goes out and the dial can then be used for jog functions.

NOTE

If the jog dial or shuttle wheel remain untouched at the center position for 10 seconds, the shuttle mode is disabled, and the indicator goes off. The STOP key lights.

7.6.1 Shuttle monitoring

This is also covered in 5, “Monitoring modes”.

The default behavior of the DA-98HR is that when shuttling the tape, you can choose whether to monitor tape or source signals when shuttling, using the tracks’ INPUT MONITOR switches.

NOTE

When monitoring in shuttle mode, the monitor signal is attenuated by 12 dB (to avoid possible damage to ears and speakers).

When AUTO MON (5.1.2, “AUTO MON”) is on, the monitoring of any armed tracks will be from the tape, unless shuttle monitoring is on, in which case, the monitoring of armed tracks will be source input. The monitoring of all other (unarmed) tracks can still be switched on a track-by-track basis using the tracks’ INPUT MONITOR switches.

Shuttle monitoring is only enabled when AUTO MON is on. When AUTO MON is off, it has no effect.

- 1 Select menu group 2, move the cursor to Shtl Mon, and press ENTER:

```
Shuttle Monitor
          off
```

- 2 Use the ▲ and ▼ keys to change the setting between off and on.

When shuttle monitoring is enabled, the SHTL MON indicator below the tape counter lights.

7.6.2 Shuttle muting

As explained above, shuttling the tape will usually allow monitoring of the tape. However, there may be times when it is necessary to mute all tape signals when shuttling.

- 1 Enter menu group 2, move the cursor to `Sht1 Mute` and press **ENTER**:

```
Shuttle Mute

                                off
```

- 2 Use the **▲** and **▼** keys to change the setting between `off` and `on`.

7.7 Reference levels

The value of the reference levels for analog input and output to and from TASCAM-supplied optional slot boards may be selected using jumpers on the boards from among three standard values: TASCAM, SMPTE and European reference levels. This operation should be performed by a qualified service engineer, and the details of the operation are provided in the documentation accompanying the boards.

The meanings of these three levels are (referenced to +4 dBu nominal levels, as provided on the IF-AD98HR slot boards):

Standard	Reference level (0 dBFS)	Nominal level	Maximum level
TASCAM	-16 dB	+4 dBu	+20 dBu
European	-18 dB	+4 dBu	+22 dBu
SMPTE	-20 dB	+4 dBu	+24 dBu

To view the reference level settings for TASCAM-supplied slot boards, perform the following steps:

- 1 Enter menu group 2, move the cursor to `Ref Level`, and press **ENTER**:

```
Analog Ref Level

Input      Output
-16 dB     -16 dB
```

If the boards are not of a type that return a decibel value when viewed in this way, the bottom line of the display shows `#0` or `#1`, as appropriate.

NOTE

Any tapes produced with the TASCAM DA-88 or DA-38 will conform to the TASCAM standard. The IF-AN98HR slot boards themselves have jumpers to convert their settings, which should be adjusted by a qualified TASCAM service engineer.

Non-TASCAM boards may or may not permit setting of reference levels from this screen. Consult the board's documentation for details.

7.8 Meter modes

The DA-98HR peak bargraph meters can be customized to suit your working preferences. Both the peak hold time and the “ballistics” of the meters can be adjusted.

7.8.1 Peak hold time

- 1 Enter menu group 2, move the cursor to `Meter Mode` and press **ENTER**:

```
Level Meter Mode

Peak Hold      Release
0 sec          Fast
```

- 2 Use the **◀** and **▶** keys to select the `Peak Hold` parameter and the **▲** and **▼** keys to set the value for the peak signal level hold time.

This value can be set to values between `0` seconds (peak levels are not held at all) and `9` seconds. There is another value, `Continue`, which permanently displays the maximum peak signal level. This can be useful if you are doing a “dry run” rehearsal, but you cannot keep your eyes on the meters all the time that the rehearsal is going on.

You can also use the function keys in the number key mode (4.4, “Using the function keys as number keys”) to enter the peak time directly.

NOTE

To turn off the peak hold display if `Continue` has been set, change the peak hold value to `0` seconds and the meter segments will “drop back”.

7.8.2 Meter ballistics

Use the same menu (`Level Meter Mode`) as described above to change the “fall-back” ballistics of the peak meters. You cannot change the rise time of the meters, which are fixed with peak meter characteristics.

7 – Advanced operations—Sine oscillator

- 1 Move the cursor to the **Release** parameter and use the **▲** and **▼** keys to select between **Slow**, **Medium** and **Fast**.

7.9 Sine oscillator

The DA-98HR incorporates a digital oscillator for lineup and signal tracing purposes. This oscillator is a sine-wave oscillator at either the standard tuning frequency of 440Hz or the standard tape line-up frequency of 1kHz.

The oscillator signal level is at the nominal signal level of +4dBu (but note that since the oscillator is a constant sine wave, it cannot truly be compared with “real-world” transient signals).

To operate the oscillator:

- 1 Enter menu 2, move the cursor to **Sine Osc.** and press **ENTER**:

```
Sine Oscillator
                                     off
```

- 2 Use the **▲** and **▼** keys to turn the oscillator between **off**, **440 Hz** and **1 kHz**.

When the oscillator is turned on, it overrides all other track inputs.

NOTE

When using the oscillator, you should turn down the monitor levels in the control room and studio to avoid damage to your ears (and the speakers).

7.9.1 Recording the oscillator

As mentioned above, the oscillator overrides all other track inputs, regardless of whether tape, digital or slot board input has been selected.

Recording the oscillator test tone is therefore similar to any other recording operation (arm the appropriate tracks and record).

7.10 Digital recording

The DA-98HR is able to accept (and output) digital signals at the **TDIF-1 (DIGITAL I/O)** connector ⁽⁵⁶⁾ in TDIF-1 format.

It is also able to accept (and output) digital signals at the **DIGITAL (AES/EBU) I/O** connector ⁽⁵¹⁾ in AES3-1992 Amendment 3-1999 format.

Consult your TASCAM distributor dealer for details of other interface units or optional slot boards for the DA-98HR which allow connection to other equipment (e.g. the IF-88SD which allows conversion between SDIF-2 and TDIF-1 formats).

The DA-98HR should be connected to other TDIF-1 equipment using a PW-88D or PW-88DL connector cable.

NOTE

Only use TASCAM digital cables when making digital audio connections to the DA-98HR. Other types of cable may cause damage to the system, and the warranty will be voided if such damage is caused by use of the wrong cables.

Make sure that the DA-98HR’s word sync clock master or slave setting is correctly made when it is connected to other digital equipment. There can only be one word clock master in a setup.

Since the TDIF-1 format carries a word clock as part of the interface, there is no need to make a word clock connection when recording through the **DIGITAL I/O** connector if the TDIF-equipped devices are the only digital audio devices in the setup. If there are other digital audio devices present, make sure that the word sync clock is properly setup throughout the device chain.

7.10.1 Selecting different inputs for recording

See the section 6.3.3, “Selecting input sources” for details of the input patchbay.

7.10.2 Selecting input word length

When data is transferred into the DA-98HR through the **TDIF (DIGITAL I/O)** ⁽⁵⁶⁾ connector, the word length of the incoming data must be set. This can be selected from between 16-bit, 20-bit or 24-bit. To set the word length:

- 1 Select menu 2, move the cursor to **Word Len.**, and press **ENTER**:

```
TDIF Word Length
                                     16 bit
```

- 2 Use the **▲** and **▼** keys to change the value between **16**, **20** and **24 bits**.

We suggest that you experiment with the dither settings (7.12, “Dither”) if you find you are recording quantization noise at low levels when the input word

7 – Advanced operations–REC MUTE (recording silence)

length is set to 20 or 24 bits and recording at 16 bits (non-HR). Though you will lose a little in the signal-to-noise ratio, total harmonic distortion figures will be improved.

NOTE

If you are dubbing tracks from a DA-88, this value must always be set to 16 bits.

7.10.3 Setting the high-frequency AES/EBU I/O transfer mode

There are two ways in which high-frequency (i.e. not at the base sampling frequency) AES/EBU data can be input and output from the DA-98HR.

NOTE

This only applies when four dual-frequency tracks have been selected (see 6.2.1, "Available tracks"). In all other cases, the output is as described in 3.1.3, "Digital audio connections (using AES/EBU)".

The first choice is `dual line`. This means that each dual-frequency digital audio signal is carried in parallel along two channels (this is the way on which the TDIF connector **always** transmits and receives high-frequency digital audio data).

The other choice is `high speed`. This means that one AES/EBU dual-sampling frequency signal is carried at high speed along one AES/EBU channel.

It is not possible to have some audio channels transmitted using one method, and others using another—all channels must be transmitted using the same method. See the table in 3.1.3, "Digital audio connections (using AES/EBU)" for further details.

To select the method:

- 1 Enter menu group A, move the cursor to `AESx2Io`, and press **ENTER**:

```
AES x2 I/O Mode
                               dual line
```

- 2 Use the **▲** and **▼** keys to change between `dual line` and `high speed`.

7.10.4 Cbit mode

When receiving AES/EBU data, the header information (the "Cbits") in the audio data contain information about the audio format, etc. If these bits indicate that the audio data being received does not match

what the DA-98HR is expecting, an appropriate message will normally be shown on screen. However, this can be over-ridden, so that no such messages are displayed. If this is done, typically no damage will result to the system, but audible noise and pitch changes, etc. may be noticeable. Without the warning messages, it may be difficult to track these down.

- 1 Enter menu group A, move the cursor to `CbitMode` and press **ENTER**:

```
Receive Cbit Mode
                               Normal
```

- 2 There are two settings here: `Normal` (warning messages are displayed) and `No Warning` (the messages are suppressed).

7.11 REC MUTE (recording silence)

There may be times when you wish to prevent any signal from reaching an armed track (in other words, when you record, you are recording silence onto the track).

- 1 Enter menu group 1, move the cursor to `Rec Mute` and press **ENTER**:

```
Rec Mute
On           ■■■■■■
Off          ■■■■■■
Trk  1  2  3  4  5  6  7  8
```

In this screen, tracks 7 and 8 are muted (no input signal is routed to them).

- 2 Use the **◀** and **▶** cursor keys to navigate between tracks. Use the **▲** and **▼** keys to switch the track muting of individual tracks on or off.

Pressing and holding the **▲** key and then pressing the **▼** key will reset the REC MUTE settings of all tracks.

7.11.1 Viewing user bits

If user bits have been recorded as part of the incoming digital data, these can be viewed in the following way:

7 – Advanced operations–Dither

- 1 Enter menu group D, and move the cursor to User bits:

```
▶User bits InBdInfo
  IoCkRange OutBdInfo
  --:--:--:--
```

- 2 The incoming user bits are displayed on the bottom line of the screen. If there are no incoming user bits, the screen displays dashes, as shown above.

7.12 Dither

Dither is the technique of adding a known noise to low-level signals, especially when converting from a high number of bits (for instance 24 or 20 input bits, as in the case of the DA-98HR) to a lower number (for instance 16 when the DA-98HR is recording in standard mode) to improve quantization.

Paradoxically, this technique of adding noise removes quantization noise and distortion at low signal levels and improves the overall distortion figures.¹

Though quantization noise is reduced, there is a loss of a few dB in the signal-to-noise ratio. For this reason, the DA-98HR does not implement dither as a standard, but allows you to choose between no dither, rectangular or triangular (the shapes refer to the distribution of values in the digital noise). Rectangular gives about 3dB better signal-to-noise ratio than triangular, but there is noise modulation, which may be audible when recording and playing back low-level program sources.

NOTE

We suggest using the confidence mode of off-tape monitoring when recording using dither in order to be able to check the effect instantly (5.3.2, “Using confidence mode”).

Dither can be turned on and off while recording is taking place. However, there will probably be an audible change in the sound quality. We suggest making a test recording before a session using confidence mode. In this way you will be able to make an instant assessment of the effects of the different dither settings on your program material.

¹A full discussion of dither and other digital audio techniques is outside the scope of this manual. However, a good starting point for learning about this, and other aspects of digital audio, is John Watkinson’s *The Art of Digital Audio*, pub Focal Press, 2nd edition 1995.

7.12.1 Selecting dither settings

- 1 Enter menu group 1, move the cursor to Dither and press ENTER.

```
Dither
      Rectangular
```

- 2 Use the ▲ and ▼ keys to select the dither function you want (Off, Rectangular or Triangular), and press ENTER to confirm the setting.

If the setting is made to anything other than off, the DITHER indicator below the tape counter lights.

7.13 Output word length

The DA-98HR can output digital audio data at either 24 bit (if the recording has been made in HR mode) or 16-bit resolution.

To select the output word length:

- 1 Select menu group B, move the cursor to OutWdLen, and press ENTER:

```
Output Word Length
      16 bit
```

- 2 Use the ▲ and ▼ keys to select between 16 bit (default) and 24 bit output.

7.14 Disabling automatic muting

By default, when there are many playback errors, the output is muted. However, this can be changed so that playback errors are audible.

NOTE

If errors are heard, the resulting noise may cause damage to hearing, as well as monitoring equipment. Only disable the error muting if you are really sure that you want to do this.

Also note that this parameter is not backed up, or saved to tape when other settings are saved (see 12.5, “Tape storage of settings”). When the unit is powered up, or settings are restored from tape, output is always muted on errors unless explicitly set otherwise.

7 – Advanced operations—Setting the power-on message

- 1 Select menu group 9, move the cursor to `ErrorMute`, and press **ENTER**:

```
Error Mute
          mute
```

- 2 Use the **▲** or **▼** key to change the `mute` to the `no mute` setting.
- 3 A message will appear asking if you are sure that you want to disable the muting. Press **ENTER** to disable the muting, otherwise press **ESCAPE**.

7.15 Setting the power-on message

You can set a power-on message of up to 20 characters (letters, numbers and some punctuation) which is displayed on the meters, using the meter segments, when the DA-98HR is turned on.

The default message is `TASCAM HR`. To set a message other than this:

- 1 Select menu group 9, move the cursor to `PwrOn Msg` and press **ENTER**:

```
Power-on Message
ROCKJOE STUDIOS
[ ] DEL CLEAR INIT
```

- 2 To clear the current message, use the **◀** and **▶** keys to move the cursor to `CLEAR` and press the **ENTER** key.
- 3 Use the **◀** and **▶** keys to move the cursor to the input field, and press the **▲** and **▼** keys to select a character.

Characters available are: `A` through `Z`, `-`, `.`, `,`, `[space]` and `1` through `9` (you can use the letter `0` for the `0` (zero) character).

Move the cursor to `DEL` and press **ENTER** to delete the character currently highlighted by the cursor.

Move the cursor to `CLEAR` and press **ENTER** to delete all the current power-on message.

- 4 Press **ENTER** to confirm the character and add it to the end of the power-on message.
- 5 Press **ESCAPE** when all characters have been entered.

NOTE

To reset the message to `TASCAM HR`, move the cursor to `INIT` and press the **ENTER** key. The current message will be erased and replaced.

8 – DTRS synchronization

This section describes the techniques and methods to be followed when the DA-98HR is linked to other DTRS units (e.g. TASCAM DA-38, DA-88, DA-98, DA-78HR, and of course other DA-98HR units).

In addition to control by a master DTRS unit, the a chain of DA-98HR and other DTRS units can be controlled by a remote control unit (for example, the RC-898 remote control unit), or the control functions on one of the TASCAM TM-D series of digital mixing consoles. In these cases, the remote control device should be connected to the REMOTE IN/SYNC IN of the master unit. Machine IDs are unaffected by this type of control.

Up to 16 DTRS units can be linked, for a total of 128 digital tracks.

If you are connecting DTRS units of different types to the DA-98HR, use the DA-98HR as the master unit and the other units as slave units.

8.1 Synchronization connections

As described in 3, “Connections”, the cable to be used when connecting the DA-98HR to other DTRS units for synchronization purposes should be a PW-88S cable. This is 1 meter (3 ft.) long.

NOTE

Be sure to use only the optional PW-88S sync cables. The use of any other cables could damage the DA-98HR.

*Be sure to connect the termination plug that comes with the PW-88S cable to the last slave's **SYNC OUT** connector, or else incorrect functions may occur.*

Turn on all the DTRS units in your system, regardless of whether you actually use all of them. A unit or units turned off will make synchronization impossible.

To synchronize multiple DTRS units, use a pre-formatted tape in the master unit, and also in the slave units. Since the DTRS system uses ABS time to achieve synchronization, tapes without ABS time recorded on them make synchronization impossible.

To synchronize multiple DTRS units, all the tapes in each unit must be formatted using the same base sampling frequency, or synchronization is impossible. It is, however,

possible to match dual- and quad-frequency tracks with base-frequency tracks in a chain, provided that they all use the same base frequency (44.1 kHz or 48 kHz).

The synchronization connections form a “daisy-chain”, with the master unit at the head of the chain, and the last slave at the tail.

Connections are made from the **SYNC OUT** (55) of one unit to the **REMOTE IN/SYNC IN** (54) of the next.

You do not need to change the **CLOCK** setting from **INT** or to connect the **WORD SYNC** connectors (50) on any of the units if the system is a DTRS-only system.

NOTE

Always make and break all synchronization connections with the power to all units in the chain turned OFF.

8.2 Machine ID and master/slave settings

Each DTRS unit in the chain must be assigned a unique machine ID. The unit at the head of the chain (the master) should have ID number 1.

Though not strictly necessary, we suggest that IDs are assigned in a consecutive sequential order from the head of the chain.

8.2.1 Differences between DTRS models

The DA-98HR, DA-78HR, DA-98 and DA-38 all use machine IDs that are set by software (the machine must be turned on for the ID to be set). The values for the IDs of these models start at “1” and go up to “16”.

The switch on the back of the DA-88 is only operative when the unit is turned off. It is marked from “0” through “F”.

When including DA-88s and other DTRS units in the same chain, add 1 to the number shown on the DA-88's rear panel machine ID switch to make the DA-88's machine ID match the series of the DA-98HR (and DA-38) IDs. Any DA-88 whose Machine ID is not 1 (the switch has been set to a value other than 0) will show its Slave ID briefly at power-on.

8 – DTRS synchronization–DTRS emulation

Therefore, for a chain of three units; a DA-98HR as master, with a DA-88 and DA-38 as slaves, the machines' IDs should be set as follows:

Unit	ID as shown	"Real" ID	How the ID is set	Power on or off when ID is set
DA-98HR	1	1	Menu system (see below)	ON
DA-88	1	2	Rotary switch on rear panel	OFF
DA-38	3	3	Tape counter menu system	ON

It therefore makes sense to set the machine IDs of all DA-88s in the chain first, immediately after connections have been made with the power off, and then turn on power to all units before setting the machine IDs of all other DTRS units in the chain.

NOTE

When you set the machine IDs, you can set the ID of any machine first, but we recommend doing this in a standard sequence, working from the head of the chain to the end.

8.2.2 Setting machine ID

- 1 Select menu group 3, move the cursor to `MCN ID`, and press **ENTER**:

```
Machine ID
          Machine 1
```

- 2 Use the **▲** and **▼** keys to select a value from 1 to 16.

NOTE

If you try to set the ID to a value other than 1 when the synchronization cable is not connected, the display shows an error message. An error message is also displayed at this time in the case of a sampling frequency mismatch. Press **ESCAPE** to remove the message, reset the ID or correct the sampling frequency, and continue.

8.2.3 Master/slave settings (CHASE mode)

Each unit with an ID greater than 1 is regarded as a slave unit.

- 1 On each slave unit, select menu group 3, move the cursor to `TimeMode` and press **ENTER**:

```
Time Mode
          ABS
```

If the bottom line does not show `ABS` (that is, if it shows `TC`), press the **▲** key so that `ABS` is displayed.

- 2 On each slave unit, press the **CHASE** key (14). The **CHASE** indicator starts to flash.
- 3 Press any of the transport controls on the master unit (machine ID 1). The slave unit(s) synchronize and follow the transport commands of the master.

When a slave unit is locked to the master unit, its **CHASE** indicator lights steadily.

- 4 To turn off chase mode on a slave unit, press the **CHASE** switch or the **STOP** key (31) so that the **CHASE** indicator goes off.

8.3 DTRS emulation

When connecting a DA-98HR in a chain to be controlled by an RC-848 or a pre-HR update RC-898 remote controller, or by one of the TM-D series of TASCAM digital mixing consoles, it may be necessary to emulate another model in the series.

- 1 Select menu group A, move the cursor to `DeviceType` and press **ENTER**:

```
Device Type Select
          DA-98HR
```

- 2 Select the emulation as explained below.

The default is (naturally) `DA-98HR`, but you can use the **▲** and **▼** keys to select any of the following: `DA-88` (DA-88 post-V4 with `SY-88` fitted giving all timecode functions when working as a slave with ID 2 or greater), `DA-38` (DA-88 pre-V4, with track copy) and `DA-98` (DA-88 post-V4) or `DA-78HR`.

8 – DTRS synchronization–Machine offset

NOTE

None of these emulations provides full control of all facilities available on the DA-98HR from the remote control unit. If the remote control unit does not support the DA-98HR, select DA-98 as the emulation. If the controller does not support the DA-98, select DA-88 as the emulation.

8.4 Machine offset

It is sometimes necessary to offset a slave unit in the chain relative to the master unit. This offset can be set to sub-frame accuracy to a maximum value of $\pm 02:00:00:00$.

NOTE

This offset is unrelated to timecode offset and refers only to the machine offset when synchronized to other DTRS units.

8.4.1 Setting machine offset

- 1 Select menu group 3, move the cursor to `McN Offset`, and press **ENTER**:

```
Machine Offset
  sample sub frame
                                ABS
+00:12:38:00.0000 sm
```

- 2 Select the sub-frame units for the offset (either samples or 1/100ths of a frame) by moving the cursor to the bottom rightmost field and using the **▲** and **▼** keys to choose between `sm` (samples) and `sf` (1/100 frame sub-frames). Note that between the time and the sub-frame type, there is an `AUTO OFFSET` setting, explained in 8.4.3, “Setting machine offset “on the fly””)
- 3 Use the **◀** and **▶** keys to select the field to be edited (hours, minutes, seconds or frames) and the **▲** and **▼** keys to change the value of that field.

You can use the function keys as number keys (4.4, “Using the function keys as number keys”) to enter the value directly.

You can also change the sign of the offset value between **+** and **-** by moving the cursor to the sign and using the **▲** and **▼** keys or by using the **+/-** key **(25)** with the **10KEY** indicator lit.

8.4.2 Cancelling machine offset

To cancel machine offset, simply set the offset value to `00:00:00:00`.

- 1 Press and hold down the **▲** key and press the **▼** key to reset the value in the `Machine Offset` menu (see above).

Machine offset is now cancelled.

8.4.3 Setting machine offset “on the fly”

As well as entering an absolute number, it is also possible to enter a number “on the fly” as the tapes are playing.

- 1 On the slave machine where the offset is to be set, select menu group 3, move the cursor to `McN Offset`, and press **ENTER**.
- 2 Make sure chase mode (8.2.3, “Master/slave settings (CHASE mode)”) is off on the slave unit.
- 3 Use the **◀** and **▶** keys to move the cursor to an “invisible” field to the right of the sub-frames field

```
Machine Offset
  sample sub frame
                                ABS
                                AUTO OFFSET
```

- 4 Locate the two tapes (master and slave) so that they have the right offset.

You can play the tapes and pause them after cueing them up, or carry out the next operation while either one or both of the tapes is being played back.

- 5 Press either the **▲** or **▼** key on the slave machine at the correct offset time to capture and store the offset.

The captured difference between the master and slave tapes is displayed on the bottom line of the display screen and stored as the machine offset.

NOTE

The value entered in this way can be edited later using the technique described above.

You cannot determine the offset from an unformatted tape, or if either tape is currently displaying a negative ABS value.

8.4.4 An example of setting offsets

A practical example of setting offsets is given here.

The master DA-98HR contains the tape with the dialog and reference tracks from the video worktape.

8 – DTRS synchronization—Machine offset

Another DA-98HR (the slave) has a tape with some tracks containing video backing music. It is necessary to produce an offset between the two so that when the master is played, the music tracks will start at the correct time relative to the dialog and reference tracks.

Copy of video worktape audio tracks

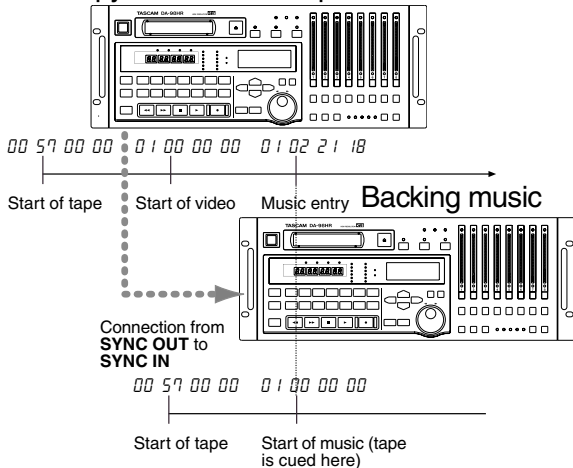

Press the ▲ or ▼ key at this point. The offset will be set to 00 02 21 18

- 1 Locate the slave tape with the backing music to the start of the music. The shuttle mode may be useful here (7.6, “Shuttle operations”).
- 2 Rewind the master to a little before you want the music to enter.
- 3 Make sure the slave is ready to accept an “on-the-fly” offset entry as described above.
- 4 Start playing the master DA-98HR.
- 5 When the music entry point is reached, press the ▲ or ▼ key on the slave machine to capture the offset point.
- 6 Stop the master, and set the slave into CHASE mode (8.2.3, “Master/slave settings (CHASE mode)”).
- 7 Rewind the master to a little before the music entry and start playing.

The slave machine now follows the transport movements of the master, with the appropriate offset, so that the music enters at the right point.

8.4.5 Clock mode

There are some circumstances where it may be necessary to use independent reference clocks on a chain of DTRS units when TC time mode (see 9.2, “Tape timecode mode”) is selected.

There are two settings, **Auto** and **Individual** (individual).

Note that this is only relevant when the time mode is set to TC, rather than ABS (see 9.1, “ABS and SMPTE/EBU timecode”).

Auto is the default, and the unit behaves as follows when this is selected.

Slave unit's time mode	Master DA-98HR	Slave DTRS units ^a
ABS	All clock sources	DTRS sync
TC	Internal	Internal
	WORD, VIDEO, AES/EBU, or SLOT	DTRS sync

a. DA-98HR, DA-78HR and v2.0 DA-98 units

If **Individual** is selected, the unit behaves as follows:

Slave unit's time mode	Master DA-98HR	Slave DTRS units ^a
ABS	All clock sources	DTRS sync
TC		Internal, WORD, VIDEO, AES/EBU or SLOT

a. DA-98HR, DA-78HR and v2.0 DA-98 units

- 1 Select menu group **A**, move the cursor to **ClkMode**, and press **ENTER**:

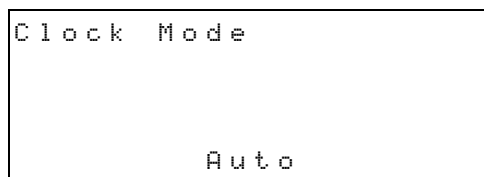

- 2 Use the ▲ and ▼ keys to select one of the two settings: **Auto** and **Individual**.

NOTE

This does not mean that you can use two different word clocks in a system—it means that the same word clock can be fed in more than one way to different units in a chain of DTRS recorders.

8 – DTRS synchronization—Digital dubbing

8.5 Digital dubbing

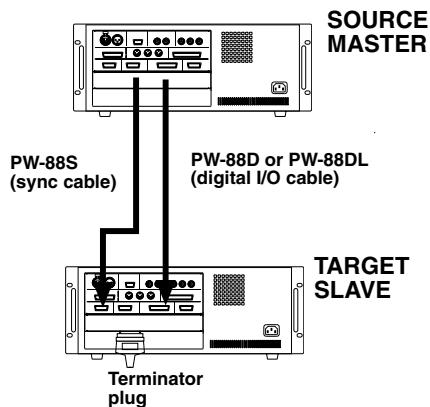

When you copy tapes between DTRS units in the digital domain, there is no loss of quality. A “work-tape” or copy is therefore indistinguishable from the original (also bear in mind that the media used by DTRS units is relatively low-cost, so making back-ups is in all ways a painless procedure).

You may want to exploit these features of the DTRS system to make archive copies, and “safety copies” of important material (see 1.5, “Recommended tapes” for our suggestions on tape use).

NOTE

When you copy tracks from DA-88 units, the input word length should be set to 16 bits.

You cannot copy from a source tape with one sampling frequency to a destination DTRS which does not support high-frequency sampling frequencies, or from an HR tape to a DTRS unit set to normal resolution (this always means the DA-88, DA-38 and DA-98 units).

- 1 With the power to all units turned OFF, make the synchronization connections as described in 8.1, “Synchronization connections”, remembering to terminate the slave unit.
- 2 Connect the DIGITAL I/O 56 of the master unit (source) to the TDIF-1 (DIGITAL I/O) of the slave (target).

Use only approved cables (PW-88D or PW-88DL) to connect the DTRS units. Use of any other cables can cause damage to the units and will invalidate the warranties.

- 3 Turn on both units. Make sure the machines’ IDs are correctly set (8.2.2, “Setting machine ID”).
- 4 Insert the master tape into the source master and a blank tape, formatted with the same

sampling frequency and bit resolution as the master tape, into the target slave.

- 5 Select the digital inputs on the target slave (this differs between models—for the DA-98HR, see 6.3.3, “Selecting input sources”).
- 6 Put the target slave machine into CHASE mode (8.2.3, “Master/slave settings (CHASE mode)”).
- 7 Locate the master tape to a point before the material you want to duplicate. The target slave also locates since it is in CHASE mode.
- 8 Arm all tracks (REC FUNCTION) on the target slave machine and make sure that all REC FUNCTION switches on the source master are turned OFF (press the ALL SAFE key to make sure).

NOTE

If any REC FUNCTION switches on the source master are turned on, you will erase your master tape! You may want to use the tape’s write-protect tab to prevent any such accidents.

- 9 On the master machine, hold down RECORD and press PLAY.

No recording will take place on the source master, but the tracks will be recorded digitally on a one-to-one basis to the target slave.

There is no need to carry out any special pre-dubbing procedure such as timing the digital output, as the digital and analog outputs are separate.

You can use the Track Copy (DA-38, DA-98) or the input patchbay functions (DA-98HR or DA-78HR) on the target slave machine to transfer tracks from the source master tape to different tracks on the target slave. Note, however, that you cannot combine tracks by this method.

8.5.1 Synchronized formatting

When several DTRS units are connected together, you can format several tapes simultaneously, using one machine as the master. This can be a very convenient way of saving time and effort.

- 1 Make sure that all machines have their IDs set, that they are connected together using the SYNC connections, as described above, and that the last unit in the chain is terminated.

- 2 Load a blank unformatted tape into each DTRS unit. You should ensure that all tapes are the same length.
- 3 Press the CHASE switch (14) on all of the slave DTRS unit(s). The indicator(s) will flash.
- 4 Press FORMAT/Fs twice within five seconds, on each of the DTRS units (master and all slaves) so that all FORMAT indicators are lit.

The first time you press the FORMAT/Fs switch, the indicator will flash. Press it again within five seconds to select format mode. If you wait more than 5 seconds, the indicator will stop flashing.

If you press the STOP (or the CLEAR or ESCAPE) key while the FORMAT indicator is lit steadily, you will cancel the format operation.

- 5 Select the same base sampling frequency (44 kHz or 48 kHz) on each DTRS unit. This sampling frequency should belong to the same frequency family as that selected on the DA-98HR (for example, it is possible to select 48 kHz as the sampling frequency on a DTRS unit that does not support the high-frequency modes supported by the DA-98HR, so long as any of 48 kHz, 96 kHz or 192 kHz are selected on the master unit.
- 6 Press and hold PLAY and press RECORD on the master. All slave units' CHASE indicators will light steadily, and the tapes will start to be formatted in synchronization.

8.5.2 Recording while formatting

As with a single-machine format process (6.2.4, "Recording while formatting"), it is possible to record while formatting.

You may want to use this feature when making a live multi-machine recording, and there has not been time to format all the tapes in advance of the performance.

Remember that you should let the tapes run to the end—you should not halt the formatting/recording process part of the way through the tape.

8.6 Error messages

These error messages may appear if there is an error with regard to DTRS synchronization:

```
WARNING!  
  
TDIF(dubbing)cable  
not connected
```

Appears if the digital cable is not connected. Reconnect the correct cable to the TDIF-1 (DIGITAL I/O) connector.

```
WARNING!  
  
No clock from MASTER  
Check connections  
and settings
```

Appears when the sync cable is not connected, the master has been turned off, or the master's sampling frequency is different from that of the slave unit's (this can include setting the master unit's ID to something other than 1). Recheck these parameters.

If either of these messages appears, correct the fault, and press the ESCAPE key to return to normal operation.

9 – Operations related to timecode

The DA-98HR contains synchronization facilities, including a timecode generator, which allow it to act either as a timecode master or a timecode slave.

If timecode is recorded, a special discrete subcode track is used, leaving all eight tracks free for recording and playback of audio material.

However, the DA-98HR is able to synchronize with external timecode devices, even if the DA-98HR tape has not been striped, by converting its internal servo subcode (ABS) to timecode “on-the-fly”. We refer to this as “synthesizing” timecode.

A full range of options is provided for full compatibility with the widest possible range of equipment.

9.1 ABS and SMPTE/EBU timecode

In some menus, by the time value, you may see either **ABS** or **TC**. Here, we explain these two different timing reference methods and the differences between them.

9.1.1 ABS time

“**ABS**” stands for “Absolute”, and is the absolute time of the tape as recorded on the subcode of the tape. This timing starts at the beginning of the tape with a value of 00:00:00:00. This is the timing reference used when the DA-98HR is not using SMPTE/EBU timecode.

Timecode (whether SMPTE or EBU) contains a fixed number of frames per second. However, the ABS method of timing works in a slightly different way.

In three seconds of time, there are 100 frames. These frames are allocated as follows:

Second	Number of frames	Maximum frame value displayed
00 – 01	33	32
01 – 02	33	32
02 – 03	34	33

This pattern is repeated every three seconds, as you will notice when you set frame values using the menu system in ABS mode. When multiple DTRS units are connected together in DTRS sync mode, the master unit always outputs ABS timings to the slave unit(s).

9.1.2 Tape timecode

“**TC**” stands for timecode, and is shown whenever a SMPTE/EBU timecode value is used rather than the ABS value.

The timecode may be internally generated or received from an external source. It can be SMPTE/EBU, received and transmitted via the **TIME CODE IN/OUT** connectors (47), or it can be SMPTE/EBU timecode synthesized from the ABS subcode (9.2, “Tape timecode mode”).

Whether the SMPTE/EBU timecode is generated or synthesized, we will refer to it as “timecode” in this manual, to distinguish it from ABS timing values.

SMPTE/EBU timecode can be re-produced independently of ABS timings and can be of any frame format supported by common timecode standards.

When multiple DTRS units are connected, and the master unit’s **CHASE** mode is set on, the master will chase to any incoming timecode, regardless of whether timecode or ABS timings have been selected as the time mode (9.1.3, “Selecting TC or ABS timing” below).

Timing information received and transmitted from and to external controllers (e.g. RS-422, MIDI or Bus) will always be referenced to timecode values.

When the DA-98HR is referenced to its absolute timecode, the **ABS** indicator to the left of the tape counter will light, and when referenced to timecode (internal or external), the **TC** indicator will light.

9.1.3 Selecting TC or ABS timing

NOTE

This procedure is fundamental to synchronization operations. If you select the ABS timing mode when you want to synchronize with timecode, you will be unable to synchronize the DA-98HR.

To change between the two different time reference modes, perform the following procedure:

- 1 Go to menu group 3, move the cursor to **TimeMode** and press **ENTER**.

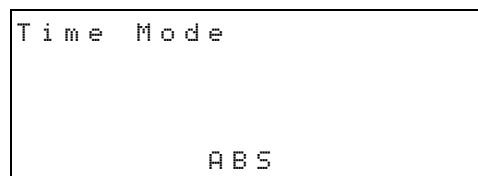

- 2 Use the **▲** and **▼** keys to select either **ABS** (absolute) or **TC** (timecode).

The appropriate indicator to the left of the tape counter (either **ABS** or **TC**) will light.

9.2 Tape timecode mode

The following procedure allows you to select the source for tape timecode when TC has been selected, as described above (including ABS timings used to synthesize SMPTE timecode. This synthesized timecode is treated exactly as if a tape had been striped with timecode).

- 1 Go to menu group 5, move the cursor to **Tape TC**, and press **ENTER**:

```
Tape TC Mode
offset Mode
00:00:00:00 ABS
```

- 2 Use the **▲** and **▼** keys to choose between the various options: **TcTrack**, **ABS**, **ABS-Ofs**, **ABS-13** and **ABS-23**.

These options are all described individually below.

9.2.1 TcTrack setting

This is the one setting in this menu which does not use the ABS conversion facility. You should only use this setting if you are using the dedicated timecode track with recorded timecode (either from an external source, from the DA-98HR's own internal generator or synthesized or assembled from ABS).

If you have selected **TcTrack** in the menu above, any timecode recorded on the tape is used as the tape timecode source.

If no timecode has been recorded on the tape, the tape counter shows all dashes **-- -- -- --**.

See 9.5, "Timecode input and output" and 9.3, "Recording timecode" for details of how to use this timecode setting.

9.2.2 ABS setting

This setting, and the settings following, synthesize timecode from the ABS subcode.

If you have selected **ABS** in the menu above, the ABS subcode time from the tape is used as the timecode, with the start of the tape having a timecode value of 00:00:00:00, as with the ABS code itself.

A negative ABS value in this mode is converted to a "before midnight" time.

The timecode frame rate used is the frame rate as selected in 9.4, "Selecting the frame rate".

NOTE

If you are using ABS timings as timecode, the hours, minutes and seconds of the ABS time will correspond to the converted timecode, **unless** the frame rate is set to 29.97 non-drop or 30 drop. In these two cases, the difference between ABS values and timecode values will be about 2 seconds per hour.

9.2.3 ABS-Ofs setting

As with the previous setting, this converts the ABS subcode timing to timecode, but allows you to add an offset to the absolute value so that the timecode does not start at the zero point.

When you select this option, the display changes to allow you to enter an offset time:

```
Tape TC Mode
offset Mode
00:00:00:00 ABS-Ofs
```

- 1 Use the **◀** and **▶** keys to choose the field to change (hours, minutes, seconds or frames) and then use the **▲** and **▼** keys to change the value of that field.

You can also enter a time offset directly using the function keys (4.4, "Using the function keys as number keys").

The time you enter is the time at which the timecode starts from the beginning of the tape. For instance, if you enter an offset of **00 59 00 00**, and the tape is positioned exactly 1 minute after the start, the timecode is **01 00 00 00**.

9.2.4 ABS-13 and ABS-23 settings

These settings are useful if you are recording many pieces on one tape. They automate the process of providing a timecode "pre-roll" and starting each piece at an easily-memorable timecode position.

The ABS-13 setting should be used to record pieces of 10 minutes or less in length, and the ABS-23 for pieces of 20 minutes or less.

With both of these settings, the start of the tape is automatically set with an offset of **HH 57 00 00**, where **HH** is the number of hours.

```
Tape TC Mode
offset Mode
00:57:00:00 ABS-13
```

9 – Operations related to timecode—Recording timecode

- 1 Use the ◀ and ▶ keys to select the “hours” field.
- 2 Use the ▲ and ▼ keys to set the “hours” value.

Here we assume (for simplicity) that the “hours” value has been set to 00. If you set this to a different value, add the appropriate offset as you read this explanation.

Timecode is synthesized, starting at 00 57 00 00, allowing three minutes of timecode “pre-roll” before the nominal start of the piece at 01 00 00 00.

With ABS-13 selected, once the tape is positioned approximately 13 minutes from the start, the timecode restarts at 01 57 00 00. If ABS-23 has been selected, this occurs approximately 23 minutes after the start of the tape (the piece is 20 minutes long). This allows another track to begin at 02 00 00 00.

This process continues until the end of the tape is reached. Wherever the tape is located, this calculation is performed, allowing you to locate each track easily with reference to the timecode values.

The diagram below shows the relationship between the “synthesized” timecode and the absolute time on tape, assuming that the “hours” value has been set to 00.

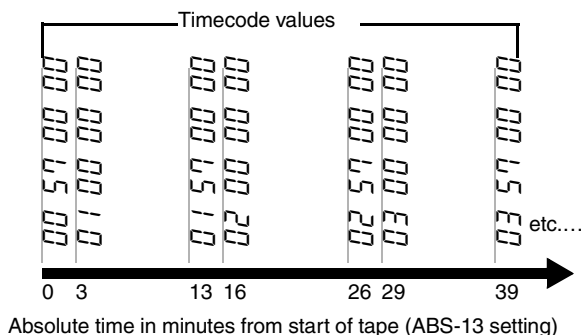

9.2.5 Checking tape TC

The **TAPE TC** indicator by the tape counter lights when either timecode recorded on tape *or* synthesized from ABS is being read.

As well as the tape counter, the display screen can also be used to show tape timecode values and the frame rate currently recorded on tape, as described below.

- 1 Go to menu group E, and move the cursor to Tape TC:

```
Ext TC      Abs Diff
▶Tape TC     Rel Diff
Gen TC      ABS Time
01:02:48:17 30ND
```

- 2 Start playing the tape.
- 3 The tape timecode value is displayed on the bottom line, together with the system frame rate.

If **TC Track** has been selected, but the timecode which has been recorded on the tape differs from the system frame rate, the frame rate at the lower right of the screen will be preceded by an asterisk (*).

9.3 Recording timecode

This section refers to the process of actually striping the timecode track with timecode.

9.3.1 Selecting the timecode source

The DA-98HR allows you to select one of three sources for recording timecode: the DA-98HR’s internal generator, an external source, or timecode based on the “Tape TC” source.

To select the source for recording timecode:

- 1 Go to menu group 8, move the cursor to TcRec Src (source for timecode recording), and press ENTER:

```
TC Record Source
Generator TC
```

- 2 Use the ▲ and ▼ keys to select a source for the timecode recording from the following options: Generator TC, Tape and External TC.

If you select **Tape**, the source of the tape timecode is also shown, as determined in the tape timecode selection menu (9.2, “Tape timecode mode”).

NOTE

Generally speaking, timecode should be recorded from an external source only when audio tracks and timecode must be transferred together from external units. In all other

9 – Operations related to timecode—Recording timecode

cases, we suggest that you use the internal generator or the tape as sources for recording timecode.

If you are recording timecode only, we suggest that you do not use external sources for recording timecode.

Set **Tape** as the source as described immediately above, and use **ABS** or **ABS-Ofs** (9.2.2, “ABS setting” and 9.2.3, “ABS-Ofs setting”) as tape timecode sources. This will ensure an accurate relationship between the timecode and the ABS timing reference (the fact that the generator must be started manually means that there will not be a tight relation between timecode and the ABS timing).

This will also allow you to synchronize multiple DTRS units accurately to external timecode, even if the slave units are not timecode-based.

If **TcTrack** is set as the Tape TC mode (9.2.1, “TcTrack setting”), and **Tape** is selected as the timecode source, the display shows **Tape (Assemble)**. See 9.3.4, “Assembling timecode” for details of how to use this function.

9.3.2 Recording timecode using the generator

1 Insert a formatted tape into the DA-98HR.

It is also possible to format and stripe a new tape simultaneously, by setting up the formatting procedure as described in 6.2, “Formatting a tape” and then following the instructions below.

2 Select timecode as the timing reference (9.1.3, “Selecting TC or ABS timing”).

3 From menu group 8, select a frame rate (9.4, “Selecting the frame rate”).

4 From menu group 8, move the cursor to **TcRec Src** (source for timecode recording) and press **ENTER**:

```
TC Record Source
  

Generator TC
```

5 Use the **▲** and **▼** keys to select the source of the timecode as **Generator TC**.

6 Go to menu group 8, move the cursor to **Gen Start** (generator start time) and press **ENTER**:

```
Generate Start Time
  

00:00:00:00 30ND
```

7 Use the **◀** and **▶** keys to select the field (hours, minutes, seconds or frames) to be edited, and the **▲** and **▼** keys to change the value.

You can also use the function keys as number keys to input the value directly, as described in 4.4, “Using the function keys as number keys”.

8 Go to menu group 8, move the cursor to **Gen Mode** (generator mode) and press **ENTER**:

```
Generate Mode
00:55:00:00 30ND
Run/Stop Mode
Stop Reset
```

9 Press the **TC REC** key (46). The indicator starts to flash.

10 With the cursor under the **Run/Stop** on the display, press the **▲** or **▼** key to start the timecode generator. The tape counter shows the generated timecode, as does the display.

11 Press and hold the **RECORD** and press the **PLAY** key and the tape starts recording timecode. The **TC REC** indicator lights steadily.

12 Press the **▲** or **▼** key with the cursor under the **Run/Stop** on the display to stop the timecode generator.

You can also start recording and then start the timecode generator. In this case, a warning message appears on the display screen as you start recording, to tell you that there is no timecode source.

If the **Mode** field is set to **Continue** rather than **Reset**, stopping the generator and then re-starting it picks up the timecode values from where it left off.

Conversely, setting this field to **Reset** restarts from the start time set above every time the generator is stopped and re-started.

It is also possible to “drop into” timecode recording by starting the transport in record mode and then

9 – Operations related to timecode—Recording timecode

pressing the **TC REC** switch. However, we do not recommend this method of working, as it is impossible to check the timecode source prior to recording.

If the method described above (arming the timecode track, and then starting recording) is used, the tape counter is used to show the output from the timecode source (the generator) when the timecode track is armed and recording (it flashes when the generator is stopped).

If there is no timecode source, the tape counter will show all hyphens (- - - - -) while the timecode track is armed.

After starting the generator, you may want to make other settings, and will therefore have to change the display screen.

The tape counter shows the timecode from the generator, but you can use the following procedure to check the frame rate, etc. especially in situations where you are using the output from the DA-98HR's generator to stripe another tape, etc.

- 1 Go to menu group E, and move the cursor to Gen TC:

```
Ext TC      Abs Diff
Tape TC     Rel Diff
▶Gen TC
01:05:12:23  30ND
```

- 2 The bottom line of the display screen shows the timecode values currently being output by the generator.

9.3.3 Recording synthesized timecode from ABS timing

When you are recording synthesized timecode from ABS, using any of the following options: **ABS**, **ABS-0fs**, **ABS-13** or **ABS-23**, as described in 9.2, "Tape timecode mode", the tape counter display behaves differently from the way as described above.

The tape counter does not flash when the timecode track is armed and the tape is stopped, and it does not display all hyphens, since the timecode source is always available.

In this case, you can start recording the timecode at any time (before or after) the tape has started moving.

9.3.4 Assembling timecode

You may want to use the assembly function when the first part of a tape contains timecode, and you want to

stripe the rest of the tape with timecode that follows on seamlessly from the originally recorded timecode.

The assembly function reads a few seconds of timecode from tape and then uses this to jamsync the internal generator, which then stripes the rest of the tape.

- 1 Select **TC Track from the Tape TC Mode menu (9.2.1, "TcTrack setting")**.
- 2 Go to menu group 8, move the cursor to **TcRec Src (timecode record source)** and press **ENTER**:

```
TC Record Source
Tape (Assemble)
```

- 3 Use the **▲** and **▼** keys to select **Tape** as shown above.
- 4 Rewind the tape to a point which already contains timecode to be used as the source for the rest of the tape.
- 5 Arm the timecode track (press **TC REC** so that the indicator is flashing). The tape counter shows the last timecode read from tape as a flashing display.
- 6 Start playing the tape. As timecode is read from the tape, the tape counter shows the values read from tape. If the tape does not contain timecode, the tape counter shows all hyphens.
- 7 Start recording when the tape counter is showing timecode (press the **RECORD** key). The **TC REC** indicator lights steadily

Timecode is laid down in a continuous stream, starting at the current timecode value. The tape counter displays continuous timecode values.

It is also possible to press the TC REC key after starting audio recording.

9.3.5 External timecode sources

The following notes should help you when you have no alternative but to record timecode on the DA-98HR from an external source (analog or digital). As mentioned earlier, though, you should only need to record timecode from an external source when the audio and timecode tracks have to be transferred together, keeping a strict relationship between the audio and timecode tracks.

9 – Operations related to timecode—Recording timecode

In all other cases, we suggest using either the DA-98HR's internal generator or timecode from tape. If you use these as sources, there will be no jitter problems, and any problems of synchronization with the digital audio clock are eliminated

NOTE

*When recording timecode from a timecode generator, ensure there is a common video reference for both the DA-98HR and the generator (set the **CLOCK** of the DA-98HR to **VIDEO**).*

When recording timecode from another DTRS unit, synchronize the two units using ABS chase (setting the timecode/audio source unit to be a slave unit as described in 8, "DTRS synchronization"). After the two units have been synchronized in this way, timecode and audio can be transferred together.

When recording timecode from a digital source (audio or video), make sure that the DA-98HR and the other unit are locked to a common word (audio recorder) or video (video recorder) clock reference. After the two machines have been synchronized in this way, timecode and audio can be transferred together.

9.3.6 Recording timecode from an analog recorder

When recording timecode from an analog recorder, feed the analog recorder or its external synchronizer and the DA-98HR with a common video source, and use the video resolve function of the analog recorder or synchronizer, if this is provided.

If the analog recorder has no video resolve function, it may have a timecode chase function, which can be driven by any timecode source from the following list:

- timecode already recorded on an audio track of the DA-98HR
- timecode recorded on other DTRS units, using ABS chase with the DA-98HR
- timecode recorded on any other recorders synchronized with the DA-98HR
- a timecode generator, video-synchronized with the DA-98HR.

NOTE

Do not use any timecode recorded on the DA-98HR's dedicated subcode track as the timecode master when transferring timecode from an analog recorder.

If your analog recorder cannot chase to external timecode, you must first record the timecode from the analog recorder on an audio track of the DA-98HR and then transfer the timecode to the dedicated timecode track.

Timecode recorded on the audio track in this way is synchronized to the audio clock, and can subsequently be transferred (through patching) to the timecode track.

9.3.7 Recording timecode from external sources

- 1 Set the Time Mode to TC (9.1.3, "Selecting TC or ABS timing").
- 2 Select the appropriate frame rate (9.4, "Selecting the frame rate") which matches the incoming timecode.
- 3 Set the timecode record source to External TC (9.3.1, "Selecting the timecode source").
- 4 Press the TC REC key to arm the timecode track.
- 5 Start the external source to check the status of the external timecode.

If no external timecode has been received since the DA-98HR has been switched on, the tape counter will show all hyphens. (- - - - -).

If external timecode has been received since the DA-98HR has been switched on, but is not currently being received, the tape counter will flash.

If the external timecode is currently being received at normal (play) speed, the tape counter will show the value of the timecode currently being received. If the external timecode is being received from a source in fast wind mode, the tape counter will flash.

If the timecode source is not clock-synchronized with the DA-98HR, a warning will be shown on the display screen. In this case, although you can record timecode, it is not recommended, as this will probably cause problems later on.

- 6 Stop the external timecode source, and rewind or reset it to a point prior to where you want recording to begin. The tape counter now starts to flash.
- 7 Restart the source. The tape counter displays the received timecode.
- 8 Press and hold down RECORD and press PLAY. Timecode is recorded from the external source onto the timecode track.

If the tape counter was flashing when the TC REC indicator was flashing (the timecode track was armed), the tape counter now shows all hyphens, and nothing will be recorded (but any

9 – Operations related to timecode—Selecting the frame rate

timecode previously recorded on the timecode track will be erased!).

9.3.8 Checking external timecode

External timecode can also be checked in another way, as described below. This method is useful for checking the frame rate of incoming timecode, if you are not sure what frame rate has been recorded or is being generated by the timecode source.

- 1 Go to menu group E, and move the cursor to Ext TC:

```
▶Ext TC      Abs Diff
Tape TC      Rel Diff
Gen TC       ABS Time
01:02:48:17  30DF
```

- 2 Incoming timecode is displayed on the bottom line, together with the frame rate of the timecode. If no incoming timecode is currently being received, the screen shows dashes (---:---:---:---).

9.4 Selecting the frame rate

The DA-98HR can use the following standards when recording and using timecode (including timecode synthesized from ABS): 30 non-drop, 30 drop, 29.97 non-drop, 29.97 drop, 25, and 24 frames per second (fps).

When using the DA-98HR to chase to a timecode master, the system frame rate on the DA-98HR must match the frame rate of the timecode master, otherwise chase operations are not possible.

The frame rate is automatically set when a tape which has been striped with timecode is inserted, or if power is switched on with a striped tape already inserted in the unit. The frame rate recorded on the tape is then used as the system frame rate.

To change the frame rate in other cases, follow the procedure below:

- 1 Go to menu group 5, move the cursor to TC Frame, and press ENTER:

```
TC Frame Mode

TC Track      System TC
none          30NDF
```

- 2 Use the ▲ and ▼ keys to change the system frame rate for your project.

- 3 The TC Track field shows the current tape stripe frame rate and cannot be changed.

9.4.1 Pull up and pull down (Fs shift)

When working in film post-production with NTSC telecine equipment, the frame rate of film (24 fps) and the NTSC color frame rate (29.97) do not form a simple mathematical ratio, and the sampling frequencies of either 44.1kHz and 48kHz are therefore affected on transfer back to film.

To avoid this, pull up and pull down functions are provided to adjust sampling frequencies to drop-frame rates, etc.

- 1 Go to menu group 8, move the cursor to Fs Shift, and press ENTER:

```
Fs Shift Mode

off
```

- 2 Use the ▲ and ▼ keys to select between Pull Down 30NDF, Pull UP 29.97 NDF, Pull UP 29.97 DF, Pull Down 30DF and Off.

The triangular PULL UP and PULL DOWN indicators by the tape counter light if the setting is anything other than Off.

NOTE

This setting is *not* memorized in the backup memory—you must reset it every time the DA-98HR is turned off and on again.

The clock source must be set to INT when using the Fs shift function to pull up, and to VIDEO when using this function to pull down.

If vari speed is enabled (7.5, “Vari speed (pitch control)”), it is not possible to use the Fs shift function.

When the Fs shift mode is operational, you cannot change the timecode frame rate (see 9.4, “Selecting the frame rate”).

9.5 Timecode input and output

Only timecode (not ABS timing) can be received via the TIME CODE IN jack.

The DA-98HR can, however, send both timecode recorded on tape, as well as ABS timings as timecode, in addition to using this time reference for multiple DTRS unit synchronization (9.5.2, “Timecode output”).

9 – Operations related to timecode—Timecode input and output

9.5.1 Timecode input

There are two primary reasons for the DA-98HR to receive timecode: when the DA-98HR is chasing to timecode, and must receive the master timecode, and when the DA-98HR is to record timecode from another unit (but see 9.3.5, “External timecode sources” below).

To view incoming timecode, follow the procedure described in 9.3.8, “Checking external timecode”.

9.5.2 Timecode output

The timecode received at the **TIME CODE IN** jack, or the timecode recorded on tape, can be output from the **TIME CODE OUT** jack (47).

When the DA-98HR is the timecode master, the timecode it outputs should be off tape.

However, when the DA-98HR is in the middle of a timecode chain, you will probably want to retransmit the incoming timecode (the **OUT** functions as a **THRU**).

- 1 Go to menu group 5, move the cursor to **OutTc Src** (output timecode source), and press **ENTER**:

```
Output TC Source
External (regen)
```

- 2 Using the **▲** and **▼** keys, select one of the three options: **Tape**; timecode will be replayed off-tape, **External (regen)**; the external timecode will be re-generated by the DA-98HR’s generator, resulting in a clean signal, or **External (reshape)**; the timecode signal will be simply filtered before being re-transmitted.

NOTE

When the DA-98HR is in **CHASE** mode, and the tape timecode mode has been set to **TC Track** (9.2, “Tape timecode mode”), the timecode output from the DA-98HR will be the received timecode, with the offset value (9.6.2, “Setting timecode offset”) added or subtracted from it. This means that any other units slaved to the timecode output do not need to have separate offset settings, but can use the master DA-98HR’s offset.

9.5.3 Timecode output format

This **Fast LTC** function controls the way in which timecode is output when fast winding the tape,

or if shuttling is carried out at greater than normal playback speed.

The **05 Frame** setting means that timecode information is not output continuously. Here, the DA-98HR reads the timecode from the tape as it is spooling, outputs 5 consecutive frames at normal speed starting with the value which has been read from tape, then reads the tape again, outputs another 5 consecutive frames based on the new tape position, and so on.

The **Leap** setting means that timecode is output continuously during fast operations, and will not be contiguous (it will leap between frames).

The **off** setting means that timecode is not output during fast operations.

- 1 Go to menu group 5, move the cursor to **Fast LTC** and press **ENTER**:

```
Fast LTC Mode
05 Frame
```

- 2 Use the **▲** or **▼** keys to select the option as described above.

9.5.4 Timecode input and output timing

Because of the nature of the digital-to-analog conversion, the timecode which is input to and output from the DA-98HR must be synchronized to match the audio timing from either the digital (either the TDIF or AES/EBU digital connectors depending on which is currently selected using the **AES/EBU** key (13)) inputs and outputs, or those of the optional analog audio slot boards.

- 1 Go to menu group 5, move the cursor to **TC Timing** (output timecode timing) and press **ENTER**:

```
TC I/O Timing
Input      Output
Analog     Analog
```

- 2 Use the **◀** and **▶** keys to select either the **Input** or the **Output** timing parameter.
- 3 Use the **▲** and **▼** keys to select between **Analog** and **Digital** for that parameter.

9 – Operations related to timecode—Chasing to timecode

9.5.5 Using MIDI Time Code (MTC)

The DA-98HR can output MIDI Time Code in almost exactly the same way as it outputs audio timecode, with the following exceptions.

MIDI Time Code is only output when the control protocol is set to MIDI. See 10.1, “Selecting the control source (protocol)” for details of how to do this using menu group 3.

MIDI Time Code can be output either when the DA-98HR is playing, or in fast forward or rewind, or when stopped. You can turn off the output during the “fast” modes and while stopped, to avoid overloading a MIDI data stream.

- 1 Go to menu group 7, move the cursor to **MTC Out.** and press **ENTER**:

```
MTC Output
Output  Fast  Stop
   on    off  off
```

- 2 Use the ◀ and ▶ cursor keys to select the field for which you want to turn MTC on and off, and the ▲ and ▼ keys to turn MTC on or off.

Note that if the **Output** field is turned off, turning the other fields on will have no effect.

NOTE

Note that the DA-98HR cannot accept MIDI timecode, and therefore cannot chase to MTC.

9.6 Chasing to timecode

The following sections describe the operation of the DA-98HR when chasing to external timecode.

The operation of the **CHASE** switch is similar to the way the **CHASE** switch is used when synchronizing DTRS units (8, “DTRS synchronization”), but in this case, the machine ID is not used.

9.6.1 Machine ID and timecode

Since a DA-98HR with machine ID set to 1 is always a master unit as regards DTRS sync operation, there is no need to make any setting on such a machine if it is to be a timecode slave. As long as timecode is

received at the **TIME CODE IN** connector (the **EXT TC** indicator is lit), a unit whose machine ID is set to 1 will automatically enter timecode chase mode when the **CHASE** key is pressed.

However, when a DA-98HR unit has its machine ID set to a value other than 1, there is a conflict when the **CHASE** key is pressed. You must determine whether the chase mode refers to timecode or to the DTRS sync, and this is done using the Time Mode menu (9.1.3, “Selecting TC or ABS timing”). If **ABS** is selected, when **CHASE** is pressed, the machine will enter DTRS sync mode, but if **TC** is selected, the machine attempts to lock to external timecode.

When the DA-98HR is in “chase-ready” mode (the **CHASE** indicator is flashing) and timecode is received at the **TIME CODE IN** connector, the DA-98HR starts to chase the timecode. When it is locked to the incoming timecode, the **CHASE** indicator lights steadily.

NOTE

The timecode frame rate used on the DA-98HR must match the frame rate of incoming timecode (9.4, “Selecting the frame rate”). If they do not match, a warning message will be shown, and the DA-98HR will not chase to timecode. You can check the frame rate of incoming timecode (See “Checking external timecode” on page 62.) and of the timecode recorded on the DA-98HR’s tape (See “Checking tape TC” on page 58).

The timecode used internally by the DA-98HR does not have to be an actual timecode striped tape. Instead, timecode can be “synthesized” from the ABS subcode timings, as described in 9.2, “Tape timecode mode”.

The exact ways in which it chases the timecode and handles transport functions, etc. are determined by a number of settings, as described below:

9.6.2 Setting timecode offset

You may enter a timecode offset for the audio from the DA-98HR to match the audio (or video sequence) from the timecode master.

As with the machine offset (8.4, “Machine offset”), you can either set this manually, entering the numbers, or set it “on-the-fly” by ear. In either case, once the offset has been entered, it can then be edited.

The offset can be set to subframe accuracy (1/100ths of 1 frame) or to sample accuracy.

9 – Operations related to timecode—Chasing to timecode

9.6.3 Setting timecode offset from the menu

- 1 Go to menu group 4, move the cursor to TC Offset and press ENTER:

```
Timecode Offset
  sample sub frame
                                30DF
+00:00:00:00.0000 sm
```

- 2 Use the ◀ and ▶ keys to select the sub-frame unit (either 1/100 frame or samples) at the bottom right of the screen, and then use the ▲ and ▼ keys to set the value in hours, minutes, seconds, frames and subframes.

You can use the function keys in the number key mode (4.4, “Using the function keys as number keys”) to enter the offset (and the leading sign) directly.

If this value is set to anything other than all zeroes, the OFFSET indicator by the tape counter lights (as long as TC is selected as the timing reference).

9.6.4 Cancelling timecode offset

When the timecode offset value is set to all zeros, timecode offset is cancelled and the OFFSET indicator goes out.

- 1 From the Timecode Offset menu described above, press the ▲ and ▼ keys simultaneously to reset the value.

9.6.5 Setting timecode offset on-the-fly

There is a second “invisible field” between the subframes and the sub-frame type fields (similar to that for machine offset settings). Moving the cursor to this field changes the display:

```
Timecode Offset
  1/100 sub frame
                                25F
  AUTO OFFSET
```

This screen allows the offset to be set by pressing the ▲ or the ▼ key. When this is done, the difference between incoming timecode and the internal timecode will be captured and stored as the timecode offset (either a positive or negative value).

Note that if the words AUTO OFFSET are not displayed on the screen, you cannot capture the offset value.

Once the offset value has been captured successfully, the display will change to show the captured offset value on the bottom line.

After the timecode offset has been entered in this way, you can “fine-tune” the value to subframe accuracy using the method described above.

9.6.6 Timecode accuracy

It is possible to set the accuracy of the timecode following mechanism of the DA-98HR to its normal mode, or to a slightly “wider” tolerance, to allow for slightly non-standard input:

- 1 Go to menu group 4, move the cursor to TC Accuracy, and press ENTER:

```
TC Accuracy
                                Normal
```

- 2 Use the ▲ and ▼ keys to choose between the Normal and Wider settings.

9.6.7 Park position

When the DA-98HR is slaved to an external timecode source, it will take some time between the master unit starting to play and starting to transmit timecode for the DA-98HR to read.

These functions allow you to measure and test the optimum pre-roll position for the DA-98HR (when it is a timecode slave) to park itself relative to the master timecode device so that it will lock up and start playing quickly.

- 1 Go to menu group 4, move the cursor to Park Posi (park position) and press ENTER:

```
Park Position
  TEST
  off 02s08f 25F
```

- 2 The time value shows the current park setting, and this can be changed using the ▲ and ▼ keys, or the function keys.

9.6.8 Automatic park position setting

When the DA-98HR is acting as a timecode slave, it can automatically determine the optimum park pre-roll position to sync with the master.

9 – Operations related to timecode—Chasing to timecode

- 1 Go to menu group 4, move the cursor to Park Posi (park position) and press ENTER:

```
Park Position
TEST
off 02s08f 25F
```

- 2 Play and stop the master tape.
- 3 Turn the DA-98HR's CHASE on, if it is off.
- 4 Use the ▲ or ▼ keys to turn the TEST parameter to on.

The DA-98HR rewinds so that the relative difference is zero. When the DA-98HR has stopped, go on to the next step below.

- 5 Play the timecode master.

When the value shown on the screen has stopped changing and is stabilized, go on to the next step below.

- 6 Turn TEST to off (▲ or ▼ key). The optimum park pre-roll time for the timecode master is now stored.

9.6.9 Absolute and relative difference

The offset as set above (9.6.2, “Setting timecode offset”) can be called the “absolute difference” between the two times. However, if the slave machine “wanders” (actually, this is unlikely), the offset (theoretical difference) will not be equal to the absolute difference. The “relative difference” is expressed as below:

Relative difference = Absolute difference – Offset

Thus, if the offset is set on a slave machine to +00:10:00:00 (10 minutes) and while chasing, the two machines' counters read as follows:

```
Master 10 15 12 12
Slave  10 05 12 08
```

the slave is now 10 minutes and 4 frames behind the master.

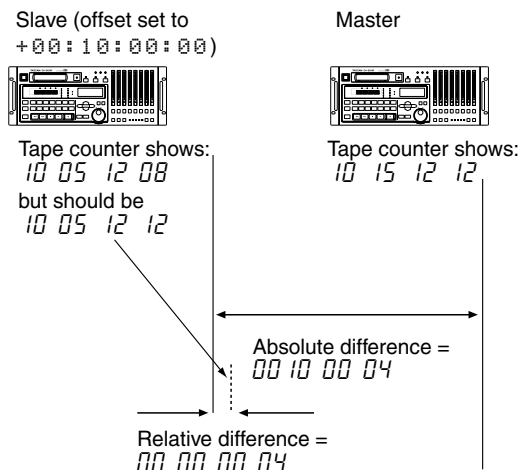

Since the slave is meant to be exactly 10 minutes behind the master, the difference, +4 frames, is the “relative difference” between the master and the slave.

To view the absolute and relative differences between master and slave machines:

- 1 Go to group menu E:

```
Ext TC  Abs Diff
Tape TC  Rel Diff
Gen TC  ABS Time
00:00:00:04 25F
```

- 2 Move the cursor to either Abs Diff (absolute difference) or Rel Diff (relative difference). The appropriate value is shown on the bottom line of the display screen.

9.6.10 Rechasing timecode

When timecode is received, the DA-98HR can either constantly monitor the internal off-tape timecode (or the synthesized equivalent as set in 9.2, “Tape timecode mode”) and the external timecode, issuing “speed-up” and “slow-down” messages to the transport to keep itself in sync (rechasing), or it can synchronize once and run freely, ignoring the incoming timecode.

While the DA-98HR is re-syncing (speeding up and slowing down), playback output will be muted, unless the clock is set to INT). Usually you should find that the DA-98HR does not need to re Chase, however, and you can leave it in free-running mode. If the timecode master tape includes a break in the timecode, though, you may want the DA-98HR to re Chase the master.

9 – Operations related to timecode–Video resolution

As well as selecting rebase, you can also select the length of the “rebase window”. This means that if the difference between internal and incoming timecode is greater than the value of this window (1 or 2 seconds in the case of the DA-98HR), the synchronizer will start to rebase.

- 1 Go to menu group 4, move the cursor to **RechsMode** (rebase mode) and press **ENTER**:

```
Rebase Mode
          Mode      Window
rebase    1 sec
```

- 2 Use the ◀ and ▶ keys to select the left **Mode** field, and the ▲ and ▼ keys to choose between **rebase** and **free**.
- 3 If you select **rebase**, use the ◀ key to move to the right field, and select a **Window** of either 1 or 2 seconds.

9.6.11 Bypassing timecode errors

As timecode is received from a remote master unit, it may be subject to errors (dropouts on the timecode master tape, etc.). These errors can cause synchronization failure (the DA-98HR will no longer be locked to the timecode of the master unit).

You can set the DA-98HR to bypass and ignore incoming timecode errors of up to 30 frames in length, or up to 10 frames in length.

- 1 Go to menu group 4, move the cursor to **ErrBypass** (Error Bypass), and press **ENTER**:

```
Error Bypass
          10 Frame
```

- 1 Use the ▲ and ▼ keys to select between 10 frame and 30 frame.

9.6.12 Individual recording while chasing timecode

If slave DTRS units are chasing a master DTRS unit, the default action is for the slaves' record status to follow that of the master. If the slaves are connected with TC as well as SYNC, and have TC rather than ABS selected as the timing reference, this default

behavior can be overridden using the function described here.

- 1 Go to menu group 4, move the cursor to **TcChs Rec** (timecode chase record), and press **ENTER**:

```
TC Chase Indiv. Rec
          enable
```

- 2 Use the ▲ and ▼ keys to select between **enable** (individual recording is possible while chasing to timecode) and **disable** (all chasing units will follow the record status of the first unit).

9.7 Video resolution

As explained above, if the DA-98HR is to be synchronized with a VTR, all units must share a common video reference for the digital audio clocks, generated either by the VTR or from a sync generator.

As well as the sample clock, the timecode can be referenced to a video clock (i.e. the start of each timecode frame is synchronized with each frame boundary received at the **VIDEO IN** terminal) or can be independent of the received frame clock.

Additionally, in a similar way to timecode rebase mode 9.6.10, “Rechasing timecode”, the DA-98HR can be set to rebase the video frame sync (muting playback output as it rebases), or to run freely once sync is achieved, ignoring any breaks in the received video signal.

- 1 Go to menu group 5, move the cursor to **Vid Rslv** (Video Resolve) and press **ENTER**:

```
Video Resolve
          on/off   Mode
          off     free
```

- 2 Use the ◀ and ▶ keys to select the frame synchronization mode (**on/off**) and the ▲ and ▼ keys to toggle it on and off.
- 3 Use the ◀ and ▶ keys to select the video rebase mode (either **free** or **re-sync**).

9 – Operations related to timecode–Video resolution

9.7.1 Video reference setting

When syncing the DA-98HR to a video frame source, it may be useful to specify the frame rate of the video source, in order to assist the synchronization process. To specify this explicitly:

- 1 Go to menu group 3, move the cursor to VideoRef, and press ENTER:

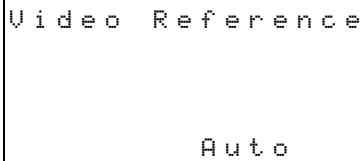

```
Video Reference
                Auto
```

- 2 Use the ▲ and ▼ keys to set this value to either Auto (the default), 30F, 29.97F, 25F or 24F.

The Auto option automatically detects and synchronizes to the incoming video frame rate. The other options force synchronization to the specified frame rate.

The DA-98HR can be controlled by other units, either through the **REMOTE IN/SYNC IN** TASCAM connector (54) as described in 8, “DTRS synchronization”, the 9-pin **RS-422** serial control connector (48), or through the **MIDI IN** connector (52) using MIDI Machine Control.

10.1 Selecting the control source (protocol)

- 1 Go to menu group 3, move the cursor to **Ctrl Prt (control protocol)** and press **ENTER**:

```
Control Protocol
          9Pin
```

- 2 Use the **▲** and **▼** keys to select between **9Pin**, **MIDI**, **Bus** and **off**.

NOTE

If MTC is to be used, **MIDI** must be selected using this screen.

These are all self-explanatory, except for the **Bus** setting, which refers to the sync/control bus carried through the **RS-422** connector (48).

NOTE

The selection of an external control protocol does not disable the local controls. When an external controller is selected, the last control pressed, whether local or remote, operates the DA-98HR.

10.2 Disabling local control

If it is required that only the selected remote controller can control the DA-98HR, press the **LOCAL DISABLE** key (15).

When this indicator is lit, no keys on the front panel of the unit are active, except for the **STOP** key and the menu viewing keys (settings can be viewed using the cursor and **ENTER/ESCAPE** keys, but not changed).

However, commands received through the **REMOTE IN/SYNC IN** (54) connector (see 8, “DTRS synchronization”) will always be valid.

10.3 Use with 9-pin external control

The RS-422 control allows the DA-98HR to be controlled by a number of different editor/controllers, in the same way as a VTR or DAT can be controlled.

10.3.1 Video clocking

If the DA-98HR is to be controlled by a video editor, it is essential that the DA-98HR and the controller receive identical video signals from the same source (a video generator, for example).

The DA-98HR should also be set with video resolve set to **ON**, either free-running or rebase (see 9.7, “Video resolution”).

After connecting the video signal, the **CLOCK** switch of the DA-98HR (45) should be pressed until the **VIDEO** indicator lights.

10.3.2 Emulation

The DA-98HR is able to emulate a number of different units, so that when a Device-ID request is sent, the appropriate reply can be sent back in response.

- 1 Go to menu group 6, move the cursor to **Emul Dev (Emulation Device)** and press **ENTER**:

```
Emulation Device
          PCM-7050
```

- 2 Use the **▲** and **▼** keys to select a device from the following list:

```
TASCAM
PCM-7050
BVH-3000
BVU-950
BVW-75
PCM-800
BVH-2000
DVR-10
```

- 3 Set your editor to control the device which is closest to the emulation you have just selected.

If the editor determines its controlling method from the reply to Device ID request, you should try using IDs starting from the top of the list.

If the editor recognizes “TASCAM” (and therefore bypasses video emulation) use the **TASCAM** emulation setting.

10 – External control—Use with 9-pin external control

10.3.3 Record delay

Most recorders (both VTRs and audio recorders) drop into record a short time after they receive the command to start recording, and editor/controllers are programmed to take this into account.

However, the DA-98HR starts recording immediately it receives the command. You can compensate for this using the Record Delay settings.

- 1 Go to menu group 6, move the cursor to **Rec Dly** (Record Delay) and press **ENTER**:

```
Record Delay
Auto (0 Frame)
```

- 2 Use the **▲** and **▼** keys to select the record delay in frames. This is the time the DA-98HR delays between receiving a record command and actually starting to record.

This value can be between 0 and 9, or the default **Auto** setting. The value of the **Auto** setting depends on the emulation selected, as shown below:

Emulation	Number of frames
TASCAM	0
PCM-7050	3
BVH-3000	4
BVU-950	6
BVW-75	3
PCM-800	0
BVH-2000	4
DVR-10	5

The delay is calculated in the following way: the first frame boundary of the video signal received at the **VIDEO IN** after the record command is received is counted as "1". This number is incremented as subsequent frames are received, and when it equals the record delay value as set above, recording starts.

If the value is set to 0, recording starts instantly on receipt of the command, and if to 1, when the first frame edge is received.

If no correct video sync signals are being received, or if video sync mode is not enabled for some reason, internal data frame timing (every 30 ms) is used instead.

NOTE

This delay is also used for controlling the timing of the monitor switching.

10.3.4 Cue-up tally

When the DA-98HR is in 9-pin protocol mode and a locate command is received, the transport locates to the desired position, and then goes into pause mode.

What is then returned to the controller depends on the following setting:

- 1 Go to menu group 6, move the cursor to **Cueup Tly** (cue-up tally), and press **ENTER**:

```
Cueup Tally
Stop
```

- 2 Use the **▲** and **▼** keys to select between **Stop** and **Still**.

Some controllers will only take their next action when they know that the controlled slaves are stopped. Select the **STOP** value for use with these controllers.

Other controllers (e.g. the LYNX II and MicroLynx synchronizers) make a distinction between pause and stop. When using such synchronizers, select the **Still** value.

10.3.5 Fast wind speed

There are two basic methods for locating which are used by controllers. The first method is to send a locate command. The second is to send fast wind and shuttle commands.

If the usual high speed winding of the DA-98HR is used with the second method, the tape will almost invariably overshoot each time and never come to rest. For that reason, you can select between the fast wind modes (at 100 times play speed) and fast shuttle (8 times play speed) depending on the method used by your controller.

- 1 Go to menu group 6, move the cursor to **Fast Spd** (fast wind speed) and press **ENTER**:

```
Fast Wind Speed
x 100
```

10 – External control—Use with 9-pin external control

2 Use the ▲ and ▼ keys to select between the two options: × 100 and × 8.

To determine whether your controller is sending (a) locate commands or (b) fast wind commands, enter a locate operation from the remote controller.

If a true location command is being sent, the screen display shows the location point for a few seconds and only the **F FWD** (30) and **REW** (29) keys light. If the second type of command is received, the display does not change, the fast forward and rewind indicators light steadily, and the **SHUTTLE** indicator (38) flashes.

10.3.6 Track mapping

When a controller arms and records on tracks, you need to specify which tracks on the controller correspond to particular tracks on the DA-98HR. The video controller protocol allows for control of up to eight digital and four analog audio tracks. The setting described here allows you to map controller tracks to DA-98HR tracks.

This mapping does not imply any correspondence between the user interface of the controller and the DA-98HR tracks—it refers to the relationship between the command signals transmitted by the controller and the DA-98HR tracks. The relationship between the user interface of the controller and the command signals must be determined using the controller itself.

NOTE

Not all eight tracks may be available, depending on the available track setting (6.2.1, “Available tracks”). Unavailable tracks will simply be ignored.

1 Go to menu group 6, move the cursor to Trk Map (track mapping) and press ENTER:

Track Mapping											
Ana	1	2	3	4							
Dig					1	2	3	4			
Trk	1	2	3	4	5	6	7	8			

The lines above show the analog and digital tracks to which the DA-98HR tracks on the bottom line are currently assigned.

The terms “analog” and “digital” used here have nothing to do with whether tracks actually are analog or digital. They correspond to the terms “Analog” and “Digital” tracks which are used by the controller.

In the assignment above, therefore, when the controller refers to analog track 3, it is actually addressing

DA-98HR track 3, and when referring to digital track 4, it is addressing DA-98HR track 8.

2 Use the ▲ and ▼ keys to select the track mapping for use with your setup. The pre-set options available are shown below:

DA-98HR track ⇒	1	2	3	4	5	6	7	8
Analog	1	2	3	4				
Digital					1	2	3	4
Analog								
Digital	1	2	3	4	5	6	7	8
Analog	1	2	3	4	1	2	3	4
Digital								
Analog	1	1	2	2	3	3	4	4
Digital								
Analog								
Digital	1	2	3	4	1	2	3	4
Analog								
Digital	1	1	2	2	3	3	4	4

There are no user-settable track mappings, but these pre-set mappings are designed to cover almost every set of circumstances.

10.3.7 Timecode track mapping

This is a special instance of track mapping, where the track corresponding to analog track 3 in the controller’s command signals is mapped either to the digital audio track selected above (10.3.6, “Track mapping”), or to the DA-98HR’s dedicated timecode track.

1 Go to menu group 6, move the cursor to TC Rec EN and press ENTER:

TC Record Enable
disable

2 Use the ▲ and ▼ keys to select between enable and disable.

If you choose **disable**, the track referred to by the controller’s command signals as “analog 3” will be the audio track designated as “analog 3” in the **Track Mapping**

10 – External control–MIDI Machine Control

ware must be able to transmit MMC commands and also to sync to MTC for this to be effective:

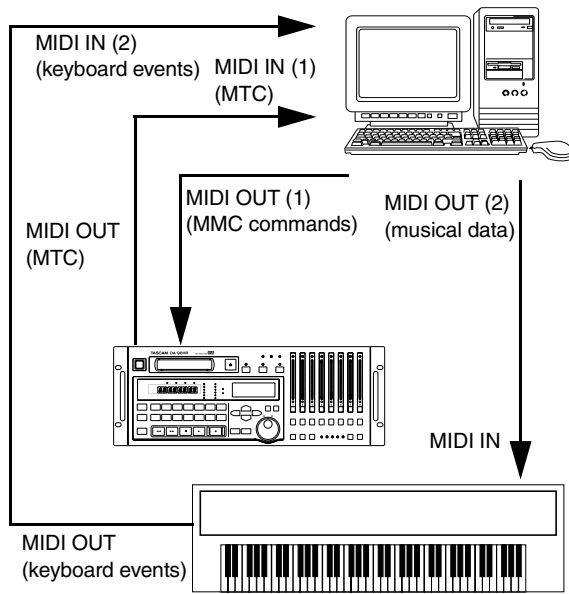

The sequencer is set up to transmit MMC commands, and is set so that it synchronizes to SMPTE/MTC.

When a “transport” command is given from the sequencer, the appropriate MMC command is transmitted to the DA-98HR. When the DA-98HR has located and starts playback (or recording), the MTC is transmitted back to the sequencer, which locks in and starts at the correct point.

In this way, though the DA-98HR is the timecode master, the sequencer is the transport master.

The arrangement shown here uses two inputs to the sequencer. The same effect could be achieved with the intelligent use of filtering mechanisms and one input to the sequencer.

11 – Menu and parameter reference

11.1 Menu groups

This section provides a quick guide to the menus and their functions, providing a list of menus in each menu group, the parameters available in each menu, and the values that each parameter can take (default

values are underlined). There is also, wherever appropriate, a reference to the section of the manual which describes the function.

Please note 11.2, “Menu item index” which provides an alphabetically-sorted list of menu functions.

11.1.1 Menu group 0

<pre> Delay Memo 1 In Patch Memo 2 Vari Spd Loc Pre </pre>			
Menu item	Parameter(s)	Values	Reference
Track Delay Time	Track Delay time Unit	<u>1</u> through <u>8</u> , ALL -200 through 7200 (samples) - 4 through 150 (msec) - default <u>0</u> SAMPLE,msec	7.3, “Track delay”
Input Patch	Input patchbay	Allows assignment of inputs from tape (T), optional slot board inputs (S) or digital inputs (D) or muting (M)	6.3.3, “Selecting input sources”
Vari Speed	Enabled Amount	Fix, Vari -6.0% through +6.0% (default is <u>0.0%</u>)	7.5, “Vari speed (pitch control)”
Memo 1	Time value	Defaults to <u>00:00:00:00</u>	7.1, “Autolocation”
Memo 2			
Locate Preroll	Minutes and seconds	<u>00min00sec</u> through <u>59min59sec</u>	7.1.3, “Setting the location pre-roll time”

11.1.2 Menu group 1

<pre> In Point X-Fade Out Point Dither Pre/Post Rec Mute </pre>			
Menu item	Parameter(s)	Values	Reference
Punch-in Point	Time value	Defaults to <u>00:00:00:00</u>	6.6, “Punch-in and punch-out”
Punch-out Point			
Preroll Postroll	Pre-roll time Post-roll time	<u>00m05s</u> through <u>59m59s</u> <u>00m03s</u> through <u>59m59s</u>	6.6.5, “Editing the pre-roll and postroll times”
Crossfade Time	Milliseconds	<u>10</u> ms through 200 ms in 10 ms steps	7.4, “Crossfade time”
Dither	Type of dither	off, Rectangular, Triangular	7.12, “Dither”
Rec Mute	Track muting	On or <u>off</u> for each track	7.11, “REC MUTE (recording silence)”

11 – Menu and parameter reference—Menu groups

11.1.3 Menu group 2

<pre>Sht1 Mute MeterMode Sht1 Mon Word Len Sine Osc. Ref Level</pre>			
Menu item	Parameter(s)	Values	Reference
Shuttle Mute	Enabled	<u>off</u> or on	7.6.2, "Shuttle muting"
Shuttle Monitor	Enabled	<u>off</u> or on	5.1.3, "Shuttle monitoring"
Sine Oscillator	Enabled	<u>off</u> , 440 Hz, 1 k Hz	7.9, "Sine oscillator"
Level Meter Mode	Hold time Release rate	0 to 9 seconds or <u>Continue</u> (default 1) <u>Slow</u> , <u>Fast</u> , <u>Medium</u>	7.8, "Meter modes"
TDIF Word Length	Length in bits of incoming data	<u>16 bit</u> , <u>20 bit</u> , <u>24 bit</u>	7.10.2, "Selecting input word length"
Analog Ref Level	Reference level in dB	<u>Input</u> , <u>Output</u> (view-only)	7.7, "Reference levels"

11.1.4 Menu group 3

<pre>Mcn ID Ctrl Prt McNOffset Trk Arm TimeMode VideoRef</pre>			
Menu item	Parameter(s)	Values	Reference
Machine ID	Machine ID for synchronization	<u>1</u> through 16	8.2.2, "Setting machine ID"
Machine Offset	Time value to sub-frame accuracy 1/100 frame or sample s/f	Defaults to <u>+00:00:00:00.0000</u> <u>±02:00:00:00</u>	8.4, "Machine offset"
Time Mode	Time reference	<u>ABS</u> , <u>TC</u>	9.1, "ABS and SMPTE/EBU timecode"
Control Protocol	Type	<u>9Pin</u> , <u>MIDI</u> , <u>Bus</u> , <u>off</u>	10, "External control"
Remote Track Arming	Enabled	<u>enable</u> , <u>disable</u>	10.3.8, "Remote track arming"
Video Reference	Automatic or frame rate	<u>Auto</u> , <u>30F</u> , <u>29.97F</u> , <u>25F</u> , <u>24F</u>	9.7.1, "Video reference setting"

11 – Menu and parameter reference—Menu groups

11.1.5 Menu group 4

<pre>TcChs Rec TC Offset RechsMode Park Posi ErrBypass TC Accrcy</pre>			
Menu item	Parameter(s)	Values	Reference
TC Chase Individ. Rec	Enabled	<u>enable</u> , disable	9.6.12, "Individual recording while chasing timecode"
Rechase Mode	Mode Window	<u>rechase</u> , free 1 sec., 2 sec	9.6.10, "Rechasing timecode"
Error Bypass	Time in frames	10 Frame, 30 Frame	9.6.11, "Bypassing timecode errors"
Timecode Offset	Time to sub-frame accuracy	Defaults to <u>+00:00:00:00.00</u> ±12:00:00:00	9.6.2, "Setting timecode offset"
Park Position	Test Manual entry	<u>off</u> , on <u>00s00f</u> through 2 seconds minus 1 frame	9.6.7, "Park position"
TC Accuracy	Width of accuracy	<u>Normal</u> , Wider	9.6.6, "Timecode accuracy"

11.1.6 Menu group 5

<pre>TC Frame Fast LTC TC Timing Vid Rslv OutTc Src Tape TC</pre>			
Menu item	Parameter(s)	Values	Reference
TC Frame Mode	System frame rate, TC track rate (view-only)	30 DF, 30 NDF, <u>29.97 DE</u> , 29.97NDF, 25 F, 24 F	9.4, "Selecting the frame rate"
TC I/O Timing	Input and output timing reference for timecode	<u>Analog</u> , Digital for both input and output	9.5.4, "Timecode input and output timing"
Output TC Source	Source of timecode output	<u>TAPE</u> (ABS or TC Track), External (regen), External (reshape)	9.5.2, "Timecode output"
Fast LTC Mode	Linear timecode in fast wind	<u>05 Frame</u> , Leap, off	9.5.3, "Timecode output format"
Video Resolve	Enabled Mode	<u>on</u> , off <u>free</u> , re-sync	9.7, "Video resolution"
Tape TC Mode	Mode	<u>TcTrack</u> , ABS, ABS-Ofs ^a , ABS-13, ABS-23	9.2, "Tape timecode mode"

a.If the ABS-Ofs (Absolute timing with offset) option is selected, the bottom line of the display changes to allow direct entry of the desired offset value.

11 – Menu and parameter reference—Menu groups

11.1.7 Menu group 6

<pre>Em1 Dev TC Rec EN Rec Dly Fast Spd Trk Map Cueup Tly</pre>			
Menu item	Parameter(s)	Values	Reference
Emulation Device	Device name	PCM-7050, BVH-3000, BVU-950, BVW-75, PCM-800, BVH-2000, DVR-10, TASCAM	10.3.2, "Emulation"
Record Delay	Time in frames	0 through 9 frames or <u>Auto</u> (the number of frames depends on the selected emulation)	10.3.3, "Record delay"
Track Mapping	Track maps	Various mappings of DA-98 tracks to analog/digital. Default is DA-98 tracks 1 through 4 correspond to analog tracks 1 through 4 and DA-98 tracks 5 through 8 correspond to digital tracks 1 through 4.	10.3.6, "Track mapping"
TC Record Enable	Enabled	<u>disable</u> , <u>enable</u>	10.3.7, "Timecode track mapping"
Fast Wind Speed	Referenced to play speed	<u>x 100</u> , <u>x 8</u>	10.3.5, "Fast wind speed"
Cueup Tally	Message to remote	<u>Stop</u> , <u>Still</u>	10.3.4, "Cue-up tally"

11.1.8 Menu group 7

<pre>MTC Out MIDI ID FunctMode Loc(Func)</pre>			
Menu item	Parameter(s)	Values	Reference
MTC Output	Output Fast wind mode Stop	<u>on</u> , <u>off</u> <u>on</u> , <u>off</u> <u>on</u> , <u>off</u>	10.5.1, "MMC and the DA-98HR"
Function Key Mode	Mode for function keys	<u>Menu</u> , <u>Locate Position</u>	4.2.1, "Function key modes"
MIDI/Bus ID	MIDI ID for MMC	001 through 127, <u>Receive</u> <u>All</u>	
Locate Position (Function Key)	Enabled Function key Time value	<u>off</u> (if function key mode is "Locate Position", location point is displayed. If the function key mode is not "Locate Position", <u>off</u> is displayed) <u>F. 1</u> through <u>F. 10</u> Defaults to 00:00:00:00	7.2, "Function key location memories"

11 – Menu and parameter reference—Menu groups

11.1.9 Menu group 8

<pre> Gen Start Fs Shift Gen Mode TcRec Src TC Frame Tape TC </pre>			
Menu item	Parameter(s)	Values	Reference
Generate Start Time	Time value	Defaults to <u>00:00:00:00</u>	9.3.2, "Recording timecode using the generator"
Generate Mode	Run/Stop Mode	<u>Stop,Run</u> <u>Reset,Continue</u>	
TC Frame Mode	System frame rate, TC track rate (view-only)	<u>30 DF,30 NDF,29.97</u> <u>DE,29.97NDF,25 F,24 F</u>	9.4, "Selecting the frame rate"
Fs Shift Mode	Pull up/down parameters	<u>off,Pull Down 30NDF,</u> <u>Pull Up 29.97NDF,</u> <u>Pull Up 29.97 DF,</u> <u>Pull Down 30DF</u>	9.4.1, "Pull up and pull down (Fs shift)"
TC Record Source	Timecode source	<u>External TC,Generator</u> <u>TC,Tape^a</u>	9.3, "Recording timecode"
Tape TC Mode	Tape timecode source	<u>TcTrack,ABS,ABS-Ofs^b,</u> <u>ABS-13,ABS-23</u>	9.2, "Tape timecode mode"

a.If Tape is selected, there will be another parameter automatically appended. This parameter will be Assemble, ABS,ABS/Offset,ABS/Auto13 or ABS/Auto23 depending on the setting made in the Tape TC Mode menu 9.2, "Tape timecode mode".

b.If the ABS-Ofs (Absolute timing with offset) option is selected, the bottom line of the display changes to allow direct entry of the desired offset value.

11.1.10 Menu group 9

<pre> Cleaning Setup BER Disp ErrorMute PwrOn Msg </pre>			
Menu item	Parameter(s)	Values	Reference
Cleaning Mode	on/off Counter	<u>off,on</u> Automatically incremented	12.1, "Head and transport cleaning"
Block Error Rate	Tape area	No parameters — shows error rate at different positions	12.2, "Checking error rates"
Power-on Message	Startup message	Defaults to <u>TASCAM HR</u>	7.15, "Setting the power-on message"
Setup	Setup memories Load/Save	<u>1,2,3</u> and F (factory) <u>Load,Save</u>	12.4, "User setups in RAM"
Error Mute	enable	<u>mute,no mute</u>	7.14, "Disabling automatic muting"

11 – Menu and parameter reference—Menu groups

11.1.11 Menu group A

<pre> ClkMode DeviceType AESx2Io ResEbuClk Cbit Mode </pre>			
Menu item	Parameter(s)	Values	Reference
Clock Mode	automatic or individual	Auto, Individual	8.4.5, "Clock mode"
AES x2 I/O Mode	High-resolution transmission	dual line, high speed	7.10.3, "Setting the high-frequency AES/EBU I/O transfer mode"
Cbit Mode	Display or ignore	Normal, No Warning	7.10.4, "Cbit mode"
Device Type Select	Device type	DA-38, DA-88, DA-98, DA-78HR, DA-98HR	8.3, "DTRS emulation"
AES/EBU Clock	AES/EBU channels to be used as clock source	Usually paired (1-2, etc.), but for dual- and quad-frequency tracks, these are grouped together.	6.1.2, "Setting the AES/EBU channel for the word sync source"

11.1.12 Menu group B

<pre> Out Patch MixInSel OutWdLen Mix Down </pre>			
Menu item	Parameter(s)	Values	Reference
Output Patch	source, and channel-track assignment	Normalled (one-to-one correspondence between tracks and channels)	5.2, "Patching the outputs"
Output Word Length	Word length of the outputs	16 bit, 24 bit	7.13, "Output word length"
Mix Input Select	Source and assignment of mixdown	S (slot), I (tape), D (digital input) Destination track (1 through 8) — default is normalled	5.4.2, "Selecting the mixdown sources"
Mix Down	channel, level and pan + master level	Channel 1 through 8, Level 0 through 127, Pan L63 through R63, master level 0 through 127	5.4.3, "Setting mixdown levels"

11 – Menu and parameter reference–Menu groups

11.1.13 Menu group D

<pre>User bits InBdInfo IoCkRange OutBdInfo</pre>			
Menu item	Parameter(s)	Values	Reference
User bits	none	Allows the viewing of received user bits	7.11.1, "Viewing user bits"
Io Board ClkRange	precision of optional slot board clock	Narrow, Wide	6.1.3, "Clock range with slot board"
Input Board Info.	none	Provides brand name, model name and firmware revision number of the fitted slot boards.	See the appropriate board manual.
Output Board Info.			

11.1.14 Menu group E

<pre>Ext TC Abs Diff Tape TC Rel Diff Gen TC ABS Time</pre>			
Menu item	Parameter(s)	Values	Reference
Ext TC	There are no user-settable values in this menu. Moving the cursor to the menu item will display the relevant value on the bottom line of the display.		9, "Operations related to timecode"
Tape TC			
Gen TC			
Abs Diff			9.6.9, "Absolute and relative difference"
Rel Diff			
ABS Time			

11.1.15 Menu group F

<pre>Sys Ver Front Ver Servo Ver Dr Total Dr Search</pre>			
Menu item	Parameter(s)	Values	Reference
Sys Ver	There are no user-settable values in this menu. Moving the cursor to the menu item will display the relevant value on the bottom line of the display.		12.6, "Checking version numbers"
Servo Ver			
Dr Search			12.1, "Head and transport cleaning"
Front Ver			12.6, "Checking version numbers"
Dr Total			12.1, "Head and transport cleaning"

11.2 Menu item index

Use this alphabetical list when you want to find out quickly to which menu group a menu item belongs.

Menu Item	Menu group
Abs Diff	E
ABS Time	E
AES x2 I/O Mode	A
AES/EBU Clock	A
Analog Ref Level	2
BER Disp	9
Cleaning Mode	9
Clock Mode	A
Control Protocol	3
Crossfade Time	1
Cueup Tally	6
Device Type Select	A
Dither	1
Dr Search	F
Dr Total	F
Emulation Device	6
Error Bypass	4
Error Mute	9
Ext TC	E
Fast LTC Mode	5
Fast Wind Speed	6
Front Ver	F
Fs Shift Mode	8
Function Key Mode	7
Gen TC	E
Generate Mode	8
Generate Start Time	8
Input Board Info.	D
Input Patch	0
Io Board Clk Range	D
Level Meter Mode	2
Locate Position	7
Locate Pre-roll	0

Menu Item	Menu group
Machine ID	3
Machine Offset	3
Memo 1	0
Memo 2	0
MIDI/Bus ID	7
Mix Down	B
Mix Input Select	B
MTC Output	7
Output Board Info.	D
Output Patch	B
Output TC Source	5
Output Word Length	B
Park Position	4
Power-on Message	9
Pre-roll / Post-roll	1
Punch-in Point	1
Punch-out Point	1
Rec Mute	1
Receive Cbit Mode	A
Rechase Mode	4
Record Delay	6
Rel Diff	E
Remote Track Arming	3
Servo Ver	F
Setup	9
Shuttle Monitor	2
Shuttle Mute	2
Sine Oscillator	2
Sys Ver	F
Tape TC	E
Tape TC Mode	5
Tape TC Mode	8
TC Accuracy	4
TC Chase Individ. Rec	4

11 – Menu and parameter reference–Menu item index

Menu Item	Menu group
TC Frame Mode	5
TC Frame Mode	8
TC Record Enable	6
TC Record Source	8
TC Timing	5
TDIF Word Length	2
Time Mode	3
Timecode Offset	4
Track Delay Time	0
Track Mapping	6
User bits	D
Vari Speed	0
Video Reference	3
Video Resolve	5

12.1 Head and transport cleaning

The DA-98HR incorporates an internal cleaning mechanism that not only cleans the rotary head, but also the tape as it enters the tape path. The provision of this cleaning mechanism significantly reduces the need for manual cleaning.

However, before recording in HR mode, because of the high bit density, dirty heads can have a significant effect on recording and playback. We therefore suggest a daily cleaning procedure as described below:

12.1.1 Daily cleaning

If this unit is used for HR recording, we suggest a daily cleaning of the heads. However, take note that excessive head cleaning may cause abrasion of the heads.

To clean the heads when recording in HR mode:

- 1 **Before inserting the tape to be used for recording, insert a suitable cleaning tape (such as the TEAC HC-8).**
- 2 **As the cleaning tape is loaded, the display shows --LoRd, followed by E. H 18t (E Hi8T), and the cleaning tape is then automatically ejected.**

This method of cleaning the heads causes minimum abrasion.

If, despite the internal cleaning mechanism and this daily cleaning operation, the **PB CONDITION** indicator (10) lights, the heads are dirty and the periodic manual cleaning procedures below should be followed.

12.1.2 Periodic cleaning

Use a TEAC HC-8 cleaning tape (as supplied with the unit, and recommended) or a dry cleaning tape specially designed for Hi8 8mm video equipment.

NOTE

NEVER use a wet-type cleaning tape, as this will result in winding problems.

The use of the dry tape will reduce the head life of the DA-98HR by about five hours. Use of manual cleaning is therefore discouraged.

We recommend the following schedule (based on our experience with the DTRS system) for cleaning and maintenance schedules. See “Checking head time”

on page 84 below for details of how to check head usage time.

Every 350 to 400 hours

Perform manual cleaning of heads and guides as described below. Check the tape path alignment after cleaning. This requires proper test and measurement equipment, and should be performed only by qualified service personnel.

Every 1000 hours (every third cleaning)

A complete alignment check should be performed.

The above cleaning cycle timings are based on the assumption that the DA-98HR is being operated in a clean environment. A dusty or smoky atmosphere will shorten the time between cleaning operations

NOTE

Most name brand tapes are of very high quality. However, it is sometimes possible to receive “bad” stock which exhibits excessive shedding characteristics. If you receive such tape stock, stop using it immediately, and follow the cleaning procedure as described below.

- 1 **Select menu group 9, move the cursor to Cleaning, and press ENTER:**

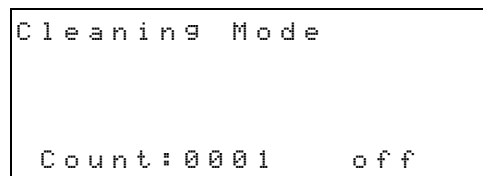

- 2 **Press the ▲ or ▼ key to set the cleaning mode to on. If a tape is loaded, it is automatically ejected.**
- 3 **Insert the cleaning tape.**
- 4 **The cleaning tape “plays” for about two seconds and then is automatically ejected. The cleaning counter (number of times the heads have been cleaned) is incremented by one.**

NOTE

Note the following points:

Do not attempt to rewind or fast forward the cleaning tape, either in the DA-98HR or in a video unit. Simply insert it into the DA-98HR when you use it the next time.

Excessive cleaning can cause excessive wear on the heads. Do not clean the heads too frequently, and never perform the head cleaning procedure more than 5 times running.

In addition to cleaning the heads, we recommend that you have the DA-98HR checked by an authorized TASCAM service technician every 500 hours or so of use.

12 – Maintenance and settings—Checking error rates

Also, before using an ME tape for archival or one-time recording (see 1.5, “Recommended tapes” for an explanation of the difference between tape types), we suggest that you clean the heads, as described here.

12.2 Checking error rates

If you hear noise and distortion on playback, even after cleaning the heads, or if you are presented with a tape of dubious quality, you may want to check the error rate of the tape.

You can check the error rates at four tape track positions, for each of the two heads (A and B) with two audio channels in each position:

- 1 Select menu group 9, move the cursor to **BER Disc** and press **ENTER**:

```
A 0000000000 B 0000000000
0000000000 0000000000
0000000000 0000000000
0000000000 0000000000
```

The two heads A and B are on the left and right respectively, with the audio channels represented as rows. From the top, the rows represent audio channels 1-2, 3-4, 5-6 and 7-8.

- 2 Start playing back the tape. Block errors are shown by a solid block.

```
A 0■00000000 B 0000000000
0000000000 0■0000000000
0000000000 0000000000
0000000000 00000000■000
```

It is inevitable that there will be a few errors, but if the display consists mainly of solid blocks while the tape is playing, something is wrong (and you will almost certainly be able to hear it!).

Use this display to show where the tape is in error, and which head is causing errors. In this way, you can pinpoint the cause of trouble.

If playing another tape seems to remove the errors, the problem is with the tape, otherwise you may want to clean the heads (12.1, “Head and transport cleaning”). Remember not to clean the heads more than 5 times in a row.

NOTE

If, after trying different tapes and cleaning the heads, you still see many errors, you should contact a TASCAM service technician to check your DA-98HR.

12.2.1 Checking head time

This function allows you to check the number of hours that the head has been used in play or record mode.

- 1 Select menu group F, and move the cursor to **Dr Total**. The number of whole hours that the head has been in use is shown on the bottom line of the display.

```
Sys ver    Front ver
Servo ver  Dr Total
Dr Search
           0214
```

12.2.2 Checking head search time

This allows you to check the number of hours that the head has spent in fast forward and rewind modes:

- 1 Select menu group F, and move the cursor to **Dr total**. The number of whole hours that the head has been in use for fast forward and fast rewind is shown on the bottom line of the display.

```
Sys ver    Front ver
Servo ver  Dr Total
Dr Search
           0064
```

12.3 Memory backup

The DA-98HR incorporates battery-backed memory which preserves almost all user settings after the power is turned off.

Settings can also be stored to one of three user RAM memories, meaning that even when settings are changed between sessions, the previous settings can be recalled. Factory settings are also recallable in the same way.

In addition, the user settings for a particular session can be stored on tape and later reloaded. This enables a tape to be transported between locations and replayed on another unit with the minimum of setup time.

12.4 User setups in RAM

Commonly-used setups are saved in one of three user setup memory banks: 1, 2 or 3. This enables pre-configuration of the DA-98HR for different jobs (video or film post-production, or different recording setups, for example). There is also a preset memory bank which contains the factory settings (see below).

When the DA-98HR is shipped, the contents of all setup memories are the same; they contain the factory settings.

12.4.1 Saving user setups

- 1 Go to menu group 9, move the cursor to **Setup** and press **ENTER**:

```

Setup
                                     Load  1  2  3  F
    
```

- 2 To save the current setup, press the **▲** key while the word **Load** is flashing so that the bottom line now reads **Save**:

```

Setup
                                     Save  1  2  3
    
```

- 3 Move the cursor (**◀** and **▶** keys) to 1, 2 or 3, and press the **▲** key:

```

Setup
  Are you sure?
                                     3
Save  1  2
    
```

- 4 To save the current setup to the selected setup memory, press the **ENTER** key.

The word **Complete** appears on the screen for about 2 seconds and the user settings are saved to the selected setup memory bank.

12.4.2 Loading user setups

- 1 Go to menu group 9, move the cursor to **Setup** and press **ENTER**:

```

Setup
                                     Load  1  2  3  F
    
```

- 2 To load the setup memory into the current memory, make sure the bottom line shows **Load**:

```

Setup
                                     Load  1  2  3  F
    
```

- 3 Move the cursor to 1, 2 or 3, and press the **▲** key:

```

Setup
  Are you sure?
                                     1
Load  2  3  F
    
```

- 4 Press **ENTER**. The word **Complete** appears on the screen for about 2 seconds. The contents of the currently-selected setup are loaded into memory and the unit resets itself.

NOTE

Since the unit resets when a user memory is loaded, you should make sure that the levels of all monitoring equipment, etc. are turned down, to avoid "thumps" and possible damage to ears and equipment.

12.4.3 Resetting the memory to factory defaults

You may sometimes want to reset all of the memory to factory settings. The values of all the factory settings are listed in 11, "Menu and parameter reference".

- 1 Follow the instructions regarding loading user setups, but choose **F** as the memory to load.
- 2 Press **ENTER**. The word **Complete** appears on the screen for about 2 seconds. The factory settings are loaded into memory and the unit resets itself.

12 – Maintenance and settings—Tape storage of settings

NOTE

Since the unit resets when the factory settings are loaded, you should make sure that the levels of all monitoring equipment, etc. are turned down, to avoid “thumps” and possible damage to ears and equipment.

12.5 Tape storage of settings

The DA-98HR saves the user parameters to tape using the first few seconds of the tape after the ABS `00 00 00 00` position. This is entirely independent of any audio data written at this position, and the same part of the tape may safely be used for user data settings and for audio.

The following settings are not saved to tape. When a set of parameters is loaded from tape, these are reset to the default values, as listed here:

- Confidence mode (off)
- Format mode (off)
- Error mute (mute)
- Rehearsal/Auto punch (off)
- Tape transport status (stop)
- REC FUNCTION (all off)
- TC Rec (disabled)
- Rec mute (all off)
- Track input monitor (all off)
- Varispeed (off)
- Sine oscillator (off)
- TC generator run/stop (stop)
- Fs shift (off)
- Cleaning (off)
- Shift mode (off)
- Data entry mode (off)

Only one set of user data may be written on each tape.

When a tape is re-formatted, the recorded settings are erased.

12.5.1 Saving settings to tape

- 1 Press the **SHIFT** key so that the indicator flashes.

- 2 Press the **◀ (SAVE)** key:

```
User Set Save
Are you sure?
```

- 3 Press the **ENTER** key to confirm the save operation. The tape rewinds to the start of the ABS code, records the settings, rewinds and verifies that the settings have been correctly written to tape.

The display shows `done` when this is performed with no errors, otherwise an error message is displayed.

If you want to cancel the save operation at the `Are you sure?` stage, press the **ESCAPE** key.

12.5.2 Loading settings from tape

- 1 Press the **SHIFT** key so that the indicator flashes.

- 2 Press the **▶ (LOAD)** key:

```
User Set Load
Are you sure?
```

- 3 Press the **ENTER** key to confirm the load operation. The tape rewinds to the start of the ABS code, and reads the settings from tape. The unit then resets itself.

The display briefly shows `done` before the reset when this load is performed with no errors, otherwise an error message is displayed (the heads may require cleaning—see 12.1, “Head and transport cleaning”).

If you want to cancel the load operation at the `Are you sure?` stage, press the **ESCAPE** key.

NOTE

Since the unit resets when the settings are loaded from tape, you should make sure that the levels of all monitoring equipment, etc. are turned down, to avoid “thumps” and possible damage to ears and equipment.

12.6 Checking version numbers

In case of problems, you may need to quote the version number of the DA-98HR's internal software components to a TASCAM representative.

1 Go to menu group F:

```
▶ Sys ver    Front ver
  Servo ver  Dr Total
  Dr Search
           Ver 32.06
```

2 Within menu group F, move the cursor so that it is by the `Sys ver` (system version), `Front ver` (front panel software version) or `Servo ver` (servo control software version) field. The version number of the appropriate software will be shown on the bottom line of the display.

12.6.1 Software upgrades

TASCAM pursues a policy of continuous improvement to products, and there may be future enhancements to the DA-98HR software. Your TASCAM dealer will be able to advise you of developments in this area.

13.1 DA-98HR options

You can purchase a number of options through your TASCAM dealer.

These include the IF-AN98HR interface boards, allowing high-quality 24-bit conversion between the analog and digital domains. These boards may be fitted in the option slots of the DA-98HR.

13.1.1 Accuride®¹ mounting

The DA-98HR is fitted with screw holes in the case which allow you to fit Accuride 200 series guide rails (20") which also help with removing and replacing the DA-98HR from and to rack installations.

Accuride strips are fitted as shown below:

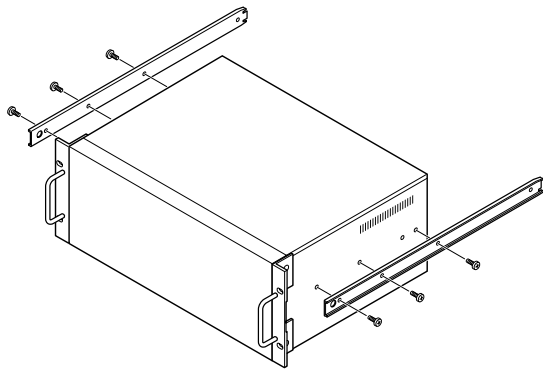

Make sure that all screws and bolts are securely tightened before replacing the DA-98HR in the rack.

13.1.2 Remote control units (RC-898, RC-848 and RC-828)

The RC-828, RC-848 and RC-898 remote control units can be used with the DA-98HR as well as the DA-78HR, DA-98, DA-88 and DA-38 DTRS recorders. However, note that not all functions of the DA-98HR can be used with these units.

The RC-898 remote control unit can be rack-mounted using the RM-8824, or placed on a roll-around stand (CS-898).

If a longer cable is required, the 10 meter (30 ft.) PW-848L can be used.

- If a remote control unit is used, it should be connected to the DA-98HR's **REMOTE IN/SYNC IN** connector (54).
- Up to 6 DTRS units can be controlled using one RC-898 controller. The first unit in the chain should be a DA-98HR.
- The first DTRS unit in the chain should be given Machine ID 1 (ID 0 for DA-88 units), even when a remote control unit is used.
- The last DTRS unit in the chain (even if it is the only one) must be terminated at the **SYNC OUT** connector (55) using a TASCAM terminator.

13.1.3 Meter unit (MU-8824)

The optional MU-8824 external meter bridge unit can be connected using a PW-88M cable from the **METER UNIT** connector (57).

The meter can be rack mounted using the RM-8824 rack mount angle accessory or mounted on the RC-898 using the MK-9824 mounting kit.

No settings are necessary on the DA-98HR to use this meter unit.

13.1.4 Cables

As mentioned earlier, TASCAM cannot accept any responsibility for damage caused by the use of the wrong cables.

Always consult your TASCAM dealer to see if there is a ready-made cable to meet your needs. The TASCAM cables to be used with the DA-98HR (at the time of writing this manual) are given in the table below:

Cable	Purpose
PW-88D	1 m (3 ft.) DA-98HR ↔ DTRS digital dubbing cable
PW-88DL	5 m (15 ft.) DA-98HR ↔ DTRS digital dubbing cable
PW-88S	1 m (3 ft.) DA-98HR ↔ DTRS sync cable
PW-1ES	1m (3 ft.) standard 9-pin RS-422 cable
PW-5ES	5m (15 ft.) standard 9-pin RS-422 cable
PW-88M	External meter connecting cable

1. Accuride is a registered trademark of Accuride International Inc.

13.2 Specifications

13.2.1 Physical specifications

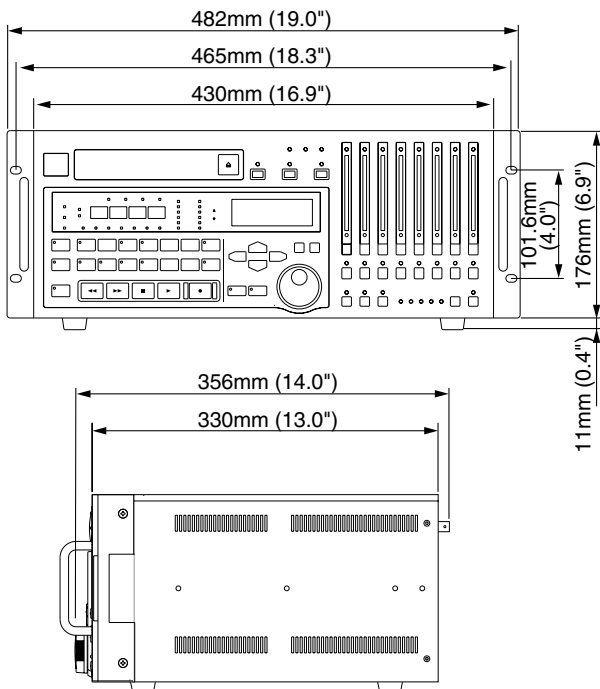

Size (exc feet)	482 x 176 x 356 (mm)
w x h x d	19 x 6.9 x 14 (in)
Weight	11 kg (24 lb)

13.2.2 Power specifications

Power requirements	USA/Canada 120 VAC, 60 Hz U.K./Europe 230 VAC, 50 Hz Australia 240 VAC, 50 Hz
Power consumption	62W
Applicable electromagnetic environment	E4
Peak inrush current	15.5 A (230 V, all options fitted)

13.2.3 Digital recording characteristics

Number of recording tracks	8
Sub-code	ABS track, SMPTE/EBU timecode facility
Sampling frequency	44.1 kHz, 48 kHz, 88.2 kHz, 96 kHz, 176.4 kHz, 192 kHz
Recording resolution	16/24 bits linear
Error correction	Double-encoded Reed-Solomon code

13.2.4 Tape recorder section

Format	DTRS format
Recording method	Rotary-head, helical-scan method
Tracking method	ATF

Erase method	Overwrite
Head construction	2 x record, 2 x playback
Tape type	Hi8 MP tape / Hi8 ME
Maximum recording time	108 min (using P6 120 tape)
Other features	Up to 16 DTRS units can be synchronized, giving up to 128 recording tracks

13.2.5 Tape transport

Vari speed	±6% (0.1% steps)
Fast forward/rewind time	80 seconds (using P6 120 tape)
Time to play from stop	Less than 2 seconds
Search speed	Maximum of 100 x play speed
Shuttle speed	Forward and reverse at 8.0, 4.0, 2.0, 1.0, 0.5 and 0.25 play speed (1.0 speed available only in forward shuttle mode)
Positioning accuracy	To 1 sample
Positioning lock time	Within 8 seconds (when locating 2 DA-98HRs synced together)

13.2.6 Inputs and outputs

TDIF-1 (DIGITAL I/O)	
Connector	25-pin D-sub
Format	TDIF-1
DIGITAL (AES/EBU)	
Connector	25-pin D-sub
Format	PRO AES3-1992 Amendment 3-1999
REMOTE IN/SYNC IN	
	15-pin D-sub
	Conforms to REMOTE IN/SYNC IN protocol
SYNC OUT	
	15-pin D-sub
	Conforms to REMOTE IN/SYNC IN protocol
WORD SYNC IN/THRU	
	BNC connector, 75Ω at TTL level ON/OFF (THRU auto-terminated)
WORD SYNC OUT	
	BNC connector, 75Ω at TTL level
METER UNIT	
	15-pin D-sub
TIME CODE IN	
	XLR-3 balanced
	Input impedance: > 10 kΩ
	Input level: 0.5 Vp-p to 10.0V p-p
TIMECODE OUT	
	XLR-3 balanced
	Output impedance (< 100 Ω)
	Output level: 2.0 V p-p

13 – Options/specifications/reference—Specifications

VIDEO IN/THRU	NTSC or PAL Negative Sync Composite Video, Sync Composite Video or Frame Pulse (auto detect) 1 V p-p, ± 0.2 V (Negative Sync Com- posite Video or Sync Composite Video) TTL Level (Frame Pulse) THRU automatically terminated (75Ω)
MIDI RS-422	IN, OUT, THRU 9-pin D-sub Conforms to RS-422 specifications
CONTROL I/O	37-pin D-sub

13.2.7 Recorder characteristics

Cross-fade time	10ms to 200ms (10ms increments)
Track delay	-200 to +7,200 samples (-4 to +150 ms) in single-unit increments. Can be set in samples or ms.
Offset	± 2 hours (to frame accuracy)

13.2.8 9-pin (RS-422), MIDI, synchronizer specifications

MIDI functions	MMC (MIDI Machine Control) MTC (MIDI timecode) output TASCAM System Exclusive (track delay, etc.) Control Change (mixdown)
Supported timecode for- mats	SMPTE 30, 29.97 drop, 29.97 non-drop, EBU 25 and Film 24 fps with telecine pull-up and pull- down facilities
Timecode offset	Up to 24 hours (jamsync capability) ABS to SMPTE conversion facility (with offset)
Video sync	Video frame resolvable even when VIDEO not selected as clock source

13 – Options/specifications/reference–MMC Bit Map Array

13.3 MMC Bit Map Array

Commands unavailable on the DA-98HR are struck through, as for example (~~RECORD PAUSE~~).

Byte	Bit 7	Bit 6 (40H)	Bit 5 (20H)	Bit 4 (10H)	Bit 3 (08H)	Bit 2 (04H)	Bit 1 (02H)	Bit 0 (01H)
c0	- 0	(06) RECORD STROBE	(05) REWIND	(04) FAST FORWARD	(03) DEFERRED PLAY	(02) PLAY	(01) STOP	(00) reserved
c1	- 0	(0D) MMC RESET	(0C) COMMAND ERROR RESET	(0B) CHASE	(0A) EJECT	(09) PAUSE	(08) RECORD PAUSE	(07) RECORD EXIT
c2	- 0	(14)	(13)	(12)	(11)	(10)	(0F)	(0E)
c3	- 0	(1B)	(1A)	(19)	(18)	(17)	(16)	(15)
c4	- 0	- 0	- 0	- 0	(1F)	(1E)	(1D)	(1C)
c5	- 0	(26)	(25)	(24)	(23)	(22)	(21)	(20)
c6	- 0	(2D)	(2C)	(2B)	(2A)	(29)	(28)	(27)
c7	- 0	(34)	(33)	(32)	(31)	(30)	(2F)	(2E)
c8	- 0	(3B)	(3A)	(39)	(38)	(37)	(36)	(35)
c9	- 0	- 0	- 0	- 0	(3F)	(3E)	(3D)	(3C)
c10	- 0	(46) SEARCH	(45) VARIABLE PLAY	(44) LOCATE	(43) UPDATE	(42) READ	(41) MASKED WRITE	(40) WRITE
c11	- 0	(4D) ADD	(4C) MOVE	(4B) MTC COMMAND	(4A) GENERATOR COMMAND	(49) ASSIGN SYS. MAS	(48) STEP	(47) SHUTTLE
c12	- 0	(54) DEFERRED VARI. PLAY	(53) COMMAND SEGMENT	(52) GROUP	(51) EVENT	(50) PROCEDURE	(4F) DROP FR. ADJUST	(4E) SUBTRACT
c13	- 0	(5B)	(5A)	(59)	(58)	(57)	(56)	(55) REC STROBE VARIABLE
c14	- 0	- 0	- 0	- 0	(5F)	(5E)	(5D)	(5C)
c15	- 0	(66)	(65)	(64)	(63)	(62)	(61)	(60)
c16	- 0	(6D)	(6C)	(6B)	(6A)	(69)	(68)	(67)
c17	- 0	(74)	(73)	(72)	(71)	(70)	(6F)	(6E)
c18	- 0	(7B)	(7A)	(79)	(78)	(77)	(76)	(75)
c19	- 0	- 0	- 0	- 0	(7F) RESUME	(7E)	(7D)	(7C) WAIT

13 – Options/specifications/reference–MMC Bit Map Array

Byte	Bit 7	Bit 6 (40H)	Bit 5 (20H)	Bit 4 (10H)	Bit 3 (08H)	Bit 2 (04H)	Bit 1 (02H)	Bit 0 (01H)
r0	- 0	(06) GENERATOR TIME CODE	(05) LOCK DEVIATION	(04) ACTUAL OFFSET	(03) REQUESTED OFFSET	(02) SELECTED MASTER CODE	(01) SELECTED TIME CODE	(00) reserved
r1	- 0	(0D) GP5	(0C) GP4	(0B) GP3	(0A) GP2	(09) GP1	(08) GP0/LOCATE POINT	(07) MTC- INPUT
r2	- 0	(14)	(13)	(12)	(11)	(10)	(0F) GP7	(0E) GP6
r3	- 0	(1B)	(1A)	(19)	(18)	(17)	(16)	(15)
r4	- 0	- 0	- 0	- 0	(1F)	(1E)	(1D)	(1C)
r5	- 0	(26) Short GENERATOR TIME CODE	(25) Short LOCK DEVIATION	(24) Short ACTUAL OFFSET	(23) Short REQUIRED OFFSET	(22) Short SELECTED MASTER CODE	(21) Short SELECTED TIME CODE	(20) reserved
r6	- 0	(2D) Short GP5	(2C) Short GP4	(2B) Short GP3	(2A) Short GP2	(29) Short GP1	(28) Short GP0 LOCATE POINT	(27) Short MTC INPUT
r7	- 0	(34)	(33)	(32)	(31)	(30)	(2F) Short GP7	(2E) Short GP6
r8	- 0	(3B)	(3A)	(39)	(38)	(37)	(36)	(35)
r9	- 0	- 0	- 0	- 0	(3F)	(3E)	(3D)	(3C)
r10	- 0	(46) SELECTED TIME CODE SOURCE	(45) TIME STANDARD	(44) COMMAND ERROR LEVEL	(43) COMMAND ERROR	(42) RESPONSE ERROR	(41) UPDATE RATE	(40) SIGNATURE
r11	- 0	(4D) RECORD STATUS	(4C) RECORD MODE	(4B) FAST MODE	(4A) STOP MODE	(49) VELOCITY TALLY	(48) MOTION CONTROL TALLY	(49) SELECTED TIME CODE USER BITS
r12	- 0	(54) STEP LENGTH	(53) TRACK INPUT MONITOR	(52) TRACK-SYNG MONITOR	(51) RECORD MONITOR	(50) GLOBAL MONITOR	(4F) TRACK RECORD READY	(4E) TRACK RECORD STATUS
r13	- 0	(5B) GENERATOR COMMAND TALLY	(5A) CHASE MODE	(59) RESOLVED PLAY MODE	(58) CONTROL DISABLE	(57) LIFTER DEFEAT	(56) FIXED SPEED	(55) PLAY SPEED REFERENCE
r14	- 0	- 0	- 0	- 0	(5F) MTC SETUP	(5E) MTC COMMAND TALLY	(5D) GENERATOR USER-BITS	(5C) GENERATOR SETUP
r15	- 0	(66)	(65) FAILURE	(64) RESPONSE SEGMENT	(63) VTC-INSERT ENABLE	(62) TRACK MUTE	(61) EVENT RESPONSE	(60) PROCEDURE RESPONSE
r16	- 0	(6D)	(6C)	(6B)	(6A)	(69)	(68)	(67)
r17	- 0	(74)	(73)	(72)	(71)	(70)	(6F)	(6E)
r18	- 0	(7B)	(7A)	(79)	(78)	(77)	(76)	(75)
r19	- 0	- 0	- 0	- 0	(7F) RESUME	(7E)	(7D)	(7C) WAIT

13.4 MIDI Implementation Chart

TASCAM Multitrack Digital Recorder		MIDI Implementation Chart		date:2000.05.20
Model DA-98HR				Version : 1.00
Function	Transmitted	Recognized	Remarks	
:Basic Default	: x	: x		
:Channel Changed	: 1-16	: 1-16		
: Mode Default	: x	: x		
: Mode Messages	: x	: x		
: Altered	: *****	: x		
: Note	: x	: x		
: Number : True voice	: *****	: x		
: Velocity Note ON	: x	: x		
: Note OFF	: x	: x		
: After Key's	: x	: x		
: Touch Ch's	: x	: x		
: Pitch Bender	: x	: x		
: 7, 9, 10, 11	: x	: o		
: Other	: x	: x		
: Control				
: Change				
: : True #	: 0/127			
: Prog	: x	: x		
: Change : True #	: 1-128			
: System Exclusive	: o	: o	: *1	
: System : Song Pos	: x	: x		
: : Song Sel	: x	: x		
: Common : Tune	: x	: x		
: System : Clock	: x	: x		
: Real Time : Commands	: x	: x		
: Aux : Local ON/OFF	: x	: x		
: : All Notes OFF	: x	: x		
: Mes- : Active Sense	: x	: x		
: sages:Reset	: x	: o		
: Notes:	: *1 MMC RP Ver 1.00 (T, R)			
: (T) : Transmitted	: Identity Request (R), Identity Reply (T)			
: (R) : Recognized	: TASCAM System Exclusive (R)			
: MTC Quarter Frame Message (T)				
Mode 1 : OMNI ON, POLY	Mode 2 : OMNI ON, MONO		o : Yes	
Mode 3 : OMNI OFF, POLY	Mode 4 : OMNI OFF, MONO		x : No	

13.5 MIDI Control Change

It is possible to send use MIDI Control Change messages to control the sub-mixer parameters, as described here:

Parameter	MIDI Control	Hex value
Channel fader	Volume (7)	0x07
Channel pan	Pan (10)	0x0a
Master fader	Control (9)	0x09
Channel mute ^a	Control (11)	0x0b

- a. Values of 0 through 63 turn mute on, values of 64 through 128 turn it on.

MIDI channels 1 through 8 control channels 1 through 8 on the master DA-98HR in a DTRS chain. MIDI channels 9 through 16 can be used to control channels 1 through 8 on the first slave DA-98HR in a chain.

13.6 MIDI System Exclusive

The following are the System Exclusive formats used by the DA-98HR:

13.6.1 Identity Reply

Reply to an Identity Request:

F0	SysEx header
7E	Universal SysEx non-realtime header
<channel>	Obtained by subtracting 1 from the Machine ID
<06>	sub-ID #1 — general information
<02>	sub-ID #2 — device identity reply
4E	TEAC ID
01	Category = recorder
04	type = digital cassette
00	interface = direct
0F	machine = DA-98HR
<VH>	Software version of unit. Numbers above decimal point, expressed in binary
<VL>	Software version of unit. Numbers below decimal point expressed in binary
00	Currently unassigned
00	Currently unassigned
F7	End of SysEx

13.6.2 TASCAM Exclusive messages

These TASCAM Exclusive messages are developed for controlling DTRS recorders connected to each other via the **SYNC IN** connections.

The messages follow the following format:

F0	SysEx header
4E	TEAC ID
<channel>	Obtained by subtracting 1 from the Machine ID
11	Operation code (DTRS SYNC IN)
<an>	Machine ID set on each DTRS recorder
<cc>	Command code
<data>	Data — format varies according to command
<cs>	checksum — lower 7 bits of the sum of all numbers from (and including) <cc> up to <cs>
F7	End of SysEx

13.6.3 Track delay

Track delay can be set from -200 through +7200

<cc> = 04

<data> is 5 bytes: <tk><da><db><dc><dd>

<tk> = 0s000ttt where s = sign bit (1 if negative) and ttt is the track number.

<da>, <db>, <dc> and <dd> represent the units, tens, hundreds and thousands digits respectively of the delay value.

13.6.4 Crossfade

Can be set from 0 to 90 ms in this way

<cc> = 05

1 data byte, taking a value from 0 through 9 (0 through 90 ms)

13.6.5 Machine offset

Used to set the machine offset of a slave machine chasing to a master via a **SYNC IN** connection (the master's chase cannot be set, of course).

The limits of this parameter are ±02:00:00.00. If a value over or below these limits are entered, the limit value will be set.

<cc> = 06

<data> is four bytes: <hh> <mm> <ss> <ff>

<hh> = 0sssuuuu, where sss=000 means a plus value, and sss=01 is a minus value. uuuu is the hours setting.

13.6.6 Input Patch setup

<cc> = 0b

There are two data bytes: <destination> and <source>.

<destination> is the tape track number – 1 (00h through 07h)

<source> is either the slot input channel number – 1 (00h through 07h), the digital input channel number +7 (08h through 0Fh), or the tape track number + 15 (10h through 17h).

In addition, if the <source> is set to 18h, the <destination> is muted.

A

ABS and SMPTE/EBU timecode 56
ABS timing 56
 recording synthesized timecode from 60
 selecting TC or ABS 56
ABS-13 and ABS-23 settings 57
ABS-Ofs setting 57
Absolute and relative difference 66
Accuracy, timecode 65
Accuride® mounting 88
AES/EBU
 connector 17
 digital audio connections 19
 key and indicator 13
 setting the channel for the word sync source 31
 setting the high-frequency I/O mode 47
ALL INPUT key 16
 INPUT MONITOR key 27
ALL SAFE key 16
Analog audio connections 19
 optional IF-AN98HR 19
Analog recorder
 Recording timecode from 61
Analog timecode connections 20
Arming tracks 72
 in pairs 29
Assembling timecode 60
Assigning a menu screen to a key 25
Assigning menus 25
Assigning MIDI and Bus ID 72
Audio connections
 AES/EBU 19
 optional IF-AN98HR 19
 TDIF-1 19
AUTO MON key 16, 27
AUTO PLAY key 14
AUTO PUNCH 14
Autolocation 40
Automatic punch point setting 36
AVAILABLE TRACK
 indicators 13
Available tracks 32

B

Basic tracks, recording 34
Bit Map Array, MMC 91
Blanking the screen display 24
Bouncing, track 35
Bus and MIDI ID assignment 72
Bus protocol 72
Bypassing timecode errors 67

C

Cables 88
Cancelling machine offset 52
Cancelling timecode offset 65
Cassettes, write-protecting 34
Cbit mode 47
Changing menu values fast 24
CHASE key 13, 51
CHASE mode
 master/slave settings 51
Chasing timecode 64
Chasing timecode, individual recording while 67
Checking
 error rates 84
 external timecode 62
 head search time 84
 head time 84
 MEMO 1 and MEMO 2 40
 tape TC 58
Cleaning 83
CLEAR key 14
Clock
 mode 53
 range with slot board 31
 selecting word sync 31
 source in a digital studio 9
 video 69
Clock connections 20
CLOCK key and indicators 16
Code (MTC), Using MIDI Time 64
Condensation 10
Confidence mode 9, 28–29
CONFIDENCE MODE key and indicator 12
Connections
 analog timecode 20
 audio 19
 control 21
 synchronization 20, 50
 to other TASCAM units 21
 video 20
 word sync clock 20
CONTROL I/O 17
Control protocol, selecting 69
Controls, front panel 12
Counter, tape 13
Crossfade time 43, 94
Cue-up tally 70
Cursor keys 15

D

Daily cleaning 83
DATA ENTRY key 15

Defaults

 factory 85
Delay
 record 70
 track 42
Dial, using to change values 24
Difference
 absolute and relative 66
Digital audio connections
 AES/EBU 19
 TDIF-1 19
Digital dubbing 54
Digital recording 46
Digital recording characteristics 89
Digital source, selecting 34
Digital studio, clock source in a 9
Disabling local control 69
Display screen 13
 blanking 24
Dither 48
 selecting settings 48
DTRS emulation 51
DTRS models, differences between 50
Dubbing (digital) 54

E

Editing
 function key memories 41
 preroll and postroll times 37
 punch points (using the menus) 37
 values 23
EJECT key 12
Emulation
 DTRS 51
 RS-422 69
ENTER key 15, 23
Environmental conditions 9
Error messages 55
Error rates, checking 84
Errors, bypassing timecode 67
Errors, Muting on playback 48
ESCAPE key 15, 23
Exiting punch-in mode 39
External control with 9-pin 69
External sources
 recording timecode from 61
External timecode
 checking 62
 sources 60

F

F1 key (LOCAL DISABLE) 13
F10 key (LOC 1) 14
F2 key (CLEAR) key 14

F3 (PREROLL) 14
 F4 key (AUTO PLAY) 14
 F5 key (MEMO 1) 14
 F6 key(MIXDOWN) 14
 F7 key (RHSL) 14
 F8 key (AUTO PUNCH) 14
 F9 key(REPEAT) 14
 Factory defaults
 resetting memory to 85
 Fast wind speed 70
 Format process 32
 FORMAT/Fs key 12
 Formatting 32
 recording while 33, 55
 synchronized with multiple units 54
 Frame rate, selecting 62
 Front panel controls 12
 Fs indicators 12
 Fs shift 62
 Function key location memories 41
 storing 41
 Function key memories
 editing 41
 locating to 41
 Function keys 25
 about 24
 as number keys 25
 assigning menus to 25
 modes 24
 recalling an assigned menu 25
 with SHIFT key 25

H

Head and transport cleaning 83
 Head search time 84
 Head time 84
 High-frequency AES/EBU I/O
 transfer mode 47
 Hold time (meters) 45
 HR mode 12

I

ID
 machine 51
 MIDI and bus 72
 IF-AN98HR 19
 Indirect word sync 21
 Individual recording while chasing
 timecode 67
 INPUT MONITOR keys 16, 27
 INPUT PATCH key 13
 Input patchbay 46
 Input sources, selecting 34
 Input word length, selecting 46

Inputs (recording) 46
 Installation 9

J

JOG/SHUTTLE key 15

K

Key location memories 41
 editing 41
 locating to 41
 storing 41
 Key modes 24

L

Level
 mixdown 30
 reference 45
 Loading settings from tape 86
 Loading user setups 85
 LOC 1 (F10) key 14
 LOC 2 (PRESET) key 14
 Local control, disabling
 LOCAL DISABLE (F1) key and
 indicator 69
 LOCAL DISABLE (F1) key and
 indicator 13
 Locating to a function key
 memory 41
 Location and playback 42
 Location memories 41
 storing 41
 Location pre-roll time, setting 40

M

Machine ID
 and master/slave settings 50
 and timecode 64
 setting 51
 Machine offset 52, 94
 cancelling 52
 setting 52
 setting “on the fly” 52
 Mapping
 timecode track 71
 track 71
 Master/slave settings
 CHASE mode 51
 machine ID 50
 MEMO 1 and MEMO 2
 locating to 41
 setting “on the fly” 40
 Memory
 resetting to factory defaults 85
 Memory backup 84

Menu function
 recalling assigned 25
 setting 25
 Menus
 assigning menu screen to a key 25
 assigning to function keys 25
 changing values fast 24
 resetting a value 24
 system navigation 23
 Messages, error 55
 Meter ballistics 45
 Meter modes 45
 Meter unit (MU-8824) 22, 88
 MIDI
 implementation Chart 93
 MIDI Machine Control 72
 MIDI Machine Control 72
 MIDI Time Code 64
 MIDI Tme Code 64
 MMC Bit Map Array 91
 System Exclusive 94
 MIDI and Bus ID, assigning 72
 MIDI Time Code (MTC) 64
 Mixdown levels 30
 Mixdown mode 29
 Mixdown patchbay 29
 Mixdown sources 30
 Monitoring controls 27
 Monitoring, shuttle 27, 44
 MU-8824 22, 88
 Multiple DTRS units 21
 Muting on errors 48
 Muting, shuttle 45

N

Navigation around the menu
 system 23
 9-pin (RS-422) specifications 90
 9-pin external control 69
 9-pin specifications 90
 Number keys, using the function
 keys as 25

O

On the fly
 setting machine offset 52
 setting MEMO 1 and MEMO 2 40
 setting punch points 36
 setting timecode offset 65
 Oscillator
 recording 46
 sine 46
 Other TASCAM units, connection
 to 21
 Output

timecode 63
timecode format 63
timecode timing 63
word length 48

Outputs
 patching 28
Overdubbing 35

P

Parallel control 21
Park position 65
 automatic setting 65
 setting 65
Patchbay
 input 34
 mixdown 29
 outputs 28
Peak hold time 45
Peak meters 13
Periodic cleaning 83
Physical specifications 89
Pitch control 43
PLAY key 15
Playback
 available time 11
 location 42
 repeat 42
+/- (MEMO 2) key 14
Postroll and preroll times, editing 37
~ IN (power) 18
Power specifications 89
Power switch 12
Power-on message, setting 49
Preparing to record 34
PREROLL (F3) and indicator 14
Preroll and postroll times
 editing 37
Pre-roll time (location)
 setting 40
PRESET key 14
Protocol
 bus 72
 selecting control 69
Pull up and pull down (Fs shift) 62
Punch points
 automatic setting 36
 setting “on the fly” 36
 setting and editing with the
 menus 37
Punch procedures
 overview 36
Punch recording
 exiting 39
 interrupting 38
 recording 38
 rehearsing 38

Punched material, reviewing 39
Punch-in and punch-out 35

R

REC FUNCTION keys 15
REC MUTE 47
Recalling an assigned menu
 function 25
Rechasing timecode 66
Recommended tapes 10
Record delay 70
RECORD key 15
Recording
 available time 11
 basic tracks 34–35
 digital 46
 digital characteristics 89
 first tracks 33
 interrupting a rehearsal or punch 38
 oscillator 46
 preparation 34
 punch-in 38
 selecting inputs 46
 silence 47
 synthesized timecode from ABS
 timing 60
 time 11
 timecode 58
 timecode from analog source 61
 timecode from external sources 61
 timecode from generator 59
 while chasing timecode 67
 while formatting 33, 55
Reference levels 45
Rehearsing the punch-in 38
Relative difference 66
Remote control units 88
REMOTE IN/SYNC IN 18
Remote track arming 72
REPEAT (F9) key 14
Repeat function 42
Repeat play 42
Resetting a menu value 24
Resetting the memory to factory
 defaults 85
Resetting the tape speed to
 standard 44
Reviewing punched material 39
RHSL (F7) key 14
RS-422 connector 21
RS-422 specifications 90

S

Saving settings to tape 86
Saving user setups 85

Screen display
 blanking 24
Search time, checking 84
Selecting control source
 (protocol) 69
Selecting digital source 34
Selecting dither settings 48
Selecting frame rate 62
Selecting input sources 34
Selecting input word length 46
Selecting mixdown sources 30
Selecting recording inputs 46
Selecting TC or ABS timing 56
Selecting timecode source 58
Selecting word sync clock 31
Setting and editing punch points
 using the menus 37
Setting location pre-roll time 40
Setting machine ID 51
Setting machine offset 52
Setting machine offset “on
 the fly” 52
Setting MEMO 1 and MEMO 2 “on
 the fly” 40
Setting mixdown levels 30
Setting power-on message 49
Setting punch points “on the fly” 36
Setting the AES/EBU channel for
 the word sync source 31
Setting the high-frequency AES/
 EBU I/O mode 47
Setting timecode offset 64
Setting timecode offset
 “on-the-fly” 65
Setting timecode offset from the
 menu 65
SHIFT key 25
SHIFT key and function keys 25
SHIFT key and indicator 15
Shuttle controls 15
Shuttle monitoring 27, 44
Shuttle muting 45
Shuttle operations 44
Sine oscillator 46
Software upgrades 87
Specifications 89
Speed, fast wind 70
Status indicators 13
STOP key 15
Storing a function key location
 memory 41
SYNC OUT 18
Synchronization connections 20, 50
Synchronized formatting 54
Synthesized timecode from ABS
 timing 60

T

Tape brands *11*
 Tape counter and status indicators *13*
 Tape loading slot *12*
 Tape storage of user settings *86*
 Tape TC, checking *58*
 Tape timecode *56*
 Tape timecode mode *57*
 Tape transport *89*
 Tape, formatting *32*
 Tapes, recommended *10*
 TASCAM units, connection to *21*
 TC or ABS timing *56*
 TC REC key *16*
 TcTrack setting *57*
 TDIF-1 *18–19*
 Telecine timing *62*
 10KEY key and indicator *14*
 TIME CODE (IN and OUT) *17*
 Time, crossfade *43*
 Time, head *84*
 Time, head search *84*
 Time, peak hold (meters) *45*
 Timecode *56*
 ABS setting *57*
 accuracy *65*
 analog connections *20*
 and Machine ID *64*
 assembling *60*
 bypassing errors *67*
 cancelling offset *65*
 chasing to *64*
 checking external *62*
 connectors *17*
 external sources *60*
 individual recording while
 chasing *67*
 input *63*
 input and output *62*
 output *63*
 output format *63*
 output timing *63*
 rechasing *66*
 recording *58*
 recording from an analog
 recorder *61*
 recording from external sources *61*
 recording using the generator *59*
 selecting source *58*
 setting offset *64*
 setting offset “on-the-fly” *65*
 setting offset from the menu *65*
 synthesized from ABS timing *60*
 tape timecode mode *57*
 track mapping *71*

Timing, TC or ABS *56*
 Track arming, remote *72*
 Track bouncing *35*
 Track delay *42, 94*
 Track mapping *71*
 timecode *71*
 Transport and head cleaning *83*

U

Unpacking *7*
 Upgrades, Software *87*
 Use with 9-pin external control *69*
 User bits, viewing *47*
 User settings
 loading *85*
 loading from tape *86*
 RAM *85*
 saving *85*
 saving to tape *86*
 tape storage of *86*
 Using the function keys as number
 keys *25*

V

Values, changing using the dial *24*
 Values, editing *23*
 Vari speed *43*
 Video
 clocking *69*
 connections *20*
 reference setting *68*
 resolution *67*

W

Wind speed *70*
 Word length
 input *46*
 output *48*
 Word sync clock *17*
 connections *20*
 from AES/EBU channel *31*
 indirect *21*
 selecting *31*
 settings *31*
 Write-protecting cassettes *34*

TASCAM

TEAC Professional Division

DA-98HR

TEAC CORPORATION

Phone: (0422) 52-5082

3-7-3, Nakacho, Musashino-shi, Tokyo 180-8550, Japan

TEAC AMERICA, INC.

Phone: (323) 726-0303

7733 Telegraph Road, Montebello, California 90640

TEAC CANADA LTD.

Phone: 905-890-8008 Facsimile: 905-890-9888

5939 Wallace Street, Mississauga, Ontario L4Z 1Z8, Canada

TEAC MEXICO, S.A. de C.V.

Phone: (525) 581-5500 Facsimile: (525) 581-5111

Campesinos 184. Col. Granjas Esmeralda. 09810.Mexico D.F.

TEAC UK LIMITED

Phone: 01923-819699

5 Marlin House, Marlin Meadow, The Croxley Centre, Watford, Herts. WD1 8YA, U.K.

TEAC DEUTSCHLAND GmbH

Phone: 0611-71580

Bahnstrasse 12, 65205 Wiesbaden-Erbenheim, Germany

TEAC FRANCE S. A.

Phone: 01.42.37.01.02

17 Rue Alexis-de-Tocqueville, CE 005 92182 Antony Cedex, France

TEAC BELGIUM NV/SA

Phone: 0162-510860

Oeverkruid 15, NL-4941 VV Raamsdonksveer, Netherlands

TEAC NEDERLAND BV

Phone: 0162-510210

Oeverkruid 15, NL-4941 VV Raamsdonksveer, Netherlands

TEAC AUSTRALIA PTY.,LTD. A.C.N. 005 408 462

Phone: (03) 9644-2442

106 Bay Street, Port Melbourne, Victoria 3207, Australia

TEAC ITALIANA S.p.A.

Phone: 02-66010500

Via C. Cantù 11, 20092 Cinisello Balsamo, Milano, Italy