

TASCAM

TEAC Professional Division

DA-60MKII

Digital Audio Tape Deck

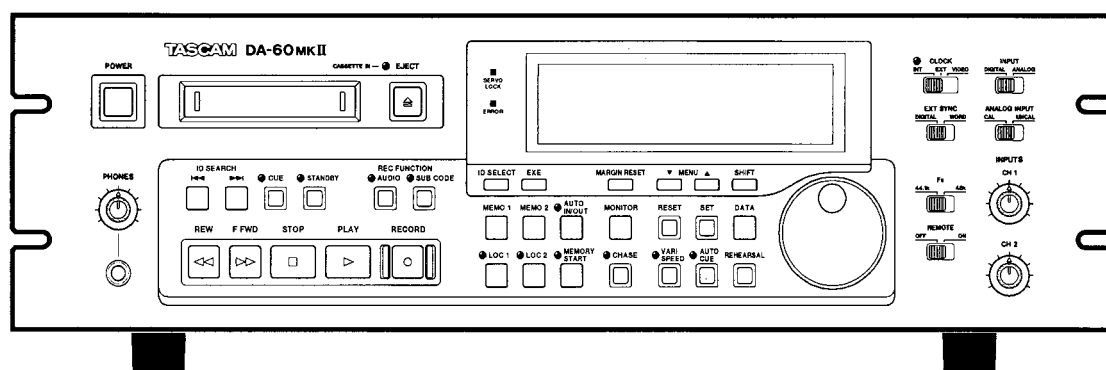

OWNER'S MANUAL

D00212900A

Important Safety Precautions



CAUTION
RISK OF ELECTRIC SHOCK
DO NOT OPEN



CAUTION: TO REDUCE THE RISK OF ELECTRIC SHOCK, DO NOT REMOVE COVER (OR BACK). NO USER-SERVICEABLE PARTS INSIDE. REFER SERVICING TO QUALIFIED SERVICE PERSONNEL.



The lightning flash with arrowhead symbol, within equilateral triangle, is intended to alert the user to the presence of uninsulated "dangerous voltage" within the product's enclosure that may be of sufficient magnitude to constitute a risk of electric shock to person.



The exclamation point within an equilateral triangle is intended to alert the user to the presence of important operating and maintenance (servicing) instructions in the literature accompanying the appliance.

This appliance has a serial number located on the rear panel. Please record the model number and serial number and retain them for your records.

Model number _____
Serial number _____

WARNING: TO PREVENT FIRE OR SHOCK HAZARD, DO NOT EXPOSE THIS APPLIANCE TO RAIN OR MOISTURE.

For U.S.A.

TO THE USER

This equipment has been tested and found to comply with the limits for a Class A digital device, pursuant to Part 15 of the FCC Rules. These limits are designed to provide reasonable protection against harmful interference when the equipment is operated in a commercial environment. This equipment generates, uses, and can radiate radio frequency energy and, if not installed and used in accordance with the instruction manual, may cause harmful interference to radio communications. Operation of this equipment in a residential area is likely to cause harmful interference in which case the user will be required to correct the interference at his own expense.

CAUTION

Changes or modifications to this equipment not expressly approved by TEAC CORPORATION for compliance could void the user's authority to operate this equipment.

For the consumers in Europe

WARNING

This is a Class A product. In a domestic environment, this product may cause radio interference in which case the user may be required to take adequate measures.

Pour les utilisateurs en Europe

AVERTISSEMENT

Il s'agit d'un produit de Classe A. Dans un environnement domestique, cet appareil peut provoquer des interférences radio, dans ce cas l'utilisateur peut être amené à prendre des mesures appropriées.

Für Kunden in Europa

Warnung

Dies ist eine Einrichtung, welche die Funk-Entstörung nach Klasse A besitzt. Diese Einrichtung kann im Wohnbereich Funkstörungen verursachen; in diesem Fall kann vom Betreiber verlangt werden, angemessene Maßnahmen durchzuführen und dafür aufzukommen.

SAFETY INSTRUCTIONS

CAUTION:

- Read all of these Instructions.
- Save these Instructions for later use.
- Follow all Warnings and Instructions marked on the audio equipment.

- 1) **Read instructions** — All the safety and operating instructions should be read before the product is operated.
- 2) **Retain instructions** — The safety and operating instructions should be retained for future reference.
- 3) **Heed Warnings** — All warnings on the product and in the operating instructions should be adhered to.
- 4) **Follow instructions** — All operating and use instructions should be followed.
- 5) **Cleaning** — Unplug this product from the wall outlet before cleaning. Do not use liquid cleaners or aerosol cleaners. Use a damp cloth for cleaning.
- 6) **Attachments** — Do not use attachments not recommended by the product manufacturer as they may cause hazards.
- 7) **Water and Moisture** — Do not use this product near water — for example, near a bath tub, wash bowl, kitchen sink, or laundry tub; in a wet basement; or near a swimming pool; and the like.
- 8) **Accessories** — Do not place this product on an unstable cart, stand, tripod, bracket, or table. The product may fall, causing serious injury to a child or adult, and serious damage to the product. Use only with a cart, stand, tripod, bracket, or table recommended by the manufacturer, or sold with the product. Any mounting of the product should follow the manufacturer's instructions, and should use a mounting accessory recommended by the manufacturer.
- 9) A product and cart combination should be moved with care. Quick stops, excessive force, and uneven surfaces may cause the product and cart combination to overturn.



10) Ventilation — Slots and openings in the cabinet are provided for ventilation and to ensure reliable operation of the product and to protect it from overheating, and these openings must not be blocked or covered. The openings should never be blocked by placing the product on a bed, sofa, rug, or other similar surface. This product should not be placed in a built-in installation such as a bookcase or rack unless proper ventilation is provided or the manufacturer's instructions have been adhered to.

11) Power Sources — This product should be operated only from the type of power source indicated on the marking label. If you are not sure of the type of power supply to your home, consult your product dealer or local power company. For products intended to operate from battery power, or other sources, refer to the operating instructions.

12) Grounding or Polarization — This product may be equipped with a polarized alternating-current line plug (a plug having one blade wider than the other). This plug will fit into the power outlet only one way. This is a safety feature. If you are unable to insert the plug fully into the outlet, try reversing the plug. If the plug should still fail to fit, contact your electrician to replace your obsolete outlet. Do not defeat the safety purpose of the polarized plug.

13) Power-Cord Protection — Power-supply cords should be routed so that they are not likely to be walked on or pinched by items placed upon or against them, paying particular attention to cords at plugs, convenience receptacles, and the point where they exit from the product.

14) Outdoor Antenna Grounding — If an outside antenna or cable system is connected to the product, be sure the antenna or cable system is grounded so as to provide some protection against voltage surges and built-up static charges. Article 810 of the National Electrical Code, ANSI/NFPA 70, provides information with regard to proper grounding of the mast and supporting structure, grounding of the lead-in wire to an antenna-discharge unit, size of grounding conductors, location of antenna-discharge unit, connection to grounding electrodes, and requirements for the grounding electrode.

"Note to CATV system installer:

This reminder is provided to call the CATV system installer's attention to Section 820-40 of the NEC which provides guidelines for proper grounding and, in particular, specifies that the cable ground shall be connected to the grounding system of the building, as close to the point of cable entry as practical.

Example of Antenna Grounding as per National Electrical Code, ANSI/NFPA 70

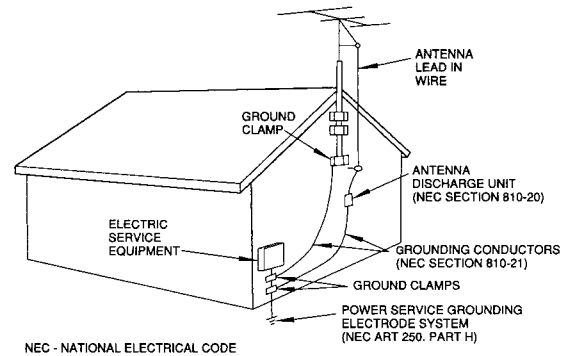

15) Lightning — For added protection for this product during a lightning storm, or when it is left unattended and unused for long periods of time, unplug it from the wall outlet and disconnect the antenna or cable system. This will prevent damage to the product due to lightning and power-line surges.

16) Power Lines — An outside antenna system should not be located in the vicinity of overhead power lines or other electric light or power circuits, or where it can fall into such power lines or circuits. When installing an outside antenna system, extreme care should be taken to keep from touching such power lines or circuits as contact with them might be fatal.

17) Overloading — Do not overload wall outlets, extension cords, or integral convenience receptacles as this can result in risk of fire or electric shock.

18) Object and Liquid Entry — Never push objects of any kind into this product through openings as they may touch dangerous voltage points or short-out parts that could result in a fire or electric shock. Never spill liquid of any kind on the product.

19) Servicing — Do not attempt to service this product yourself as opening or removing covers may expose you to dangerous voltage or other hazards. Refer all servicing to qualified service personnel.

20) Damage Requiring Service — Unplug this product from the wall outlet and refer servicing to qualified service personnel under the following conditions:

- a) when the power-supply cord or plug is damaged.
- b) if liquid has been spilled, or objects have fallen into the product.
- c) if the product has been exposed to rain or water.
- d) if the product does not operate normally by following the operating instructions. Adjust only those controls that are covered by the operating instructions as an improper adjustment of other controls may result in damage and will often require extensive work by a qualified technician to restore the product to its normal operation.
- e) if the product has been dropped or damaged in any way.
- f) when the product exhibits a distinct change in performance — this indicates a need for service.

21) Replacement Parts — When replacement parts are required, be sure the service technician has used replacement parts specified by the manufacturer or have the same characteristics as the original part. Unauthorized substitutions may result in fire, electric shock, or other hazards.

22) Safety Check — Upon completion of any service or repairs to this product, ask the service technician to perform safety checks to determine that the product is in proper operating condition.

23) Wall or Ceiling Mounting — The product should be mounted to a wall or ceiling only as recommended by the manufacturer.

24) Heat — The product should be situated away from heat sources such as radiators, heat registers, stoves, or other products (including amplifiers) that produce heat.

SECTION 1 : INTRODUCTION

The DA-60 MKII was designed for professional use and its features include the following :

- 4-head, 4-DD mechanism
- Punch-in/out (with digital crossfade)
- Variable speed playback
- Auto Cue/Memory Start ensuring instant play start from the exact point
- Autolocation
- Fade in and out of play or record
- Digital audio interface conforming to AES/EBU standards
- External sync (referenced to Word Sync signal)
- Parallel data port and RS-422 serial data port for interface to external controllers
- Record and read of SMPTE/EBU/FILM timecodes, following IEC standards
- Timecode generator integrated
- Timecode-controlled synchronization
- Slaving to an incoming composite video or a film sync signal

Using this manual

Before actually using the DA-60 MKII, please read this manual thoroughly at least once, so you will know where to return to when you need answers. Even though a quick glance will get you going, careful study will ensure that misunderstandings won't slow you down.

Use of capital letters : In general, we use all upper case type to designate a particular switch, control or connector label.

Installation Site

The DA-60 MKII may be used in most area, but to maintain top performance and prolong operating life, observe the following environmental limitations :

- 1) Nominal temperature should be 5 to 35 degrees Centigrade (41 to 95 degrees Fahrenheit).
- 2) Relative humidity should be 30 to 90% (non-condensing).
- 3) Strong magnetic fields should not exist nearby.

Beware of Condensation

When the DA-60 MKII is moved from a cold to a warm place or used after sudden temperature change, there is the danger of condensation ; water vapor in the air could condense on the internal mechanism, making correct operation impossible. To prevent this, or if this occurs, leave the DA-60 MKII for 1 or 2 hours with power turned on, then turn off power and switch on again.

Mounting in a 19" Rack

- Be sure to leave a 1 U or more space on top of the unit.

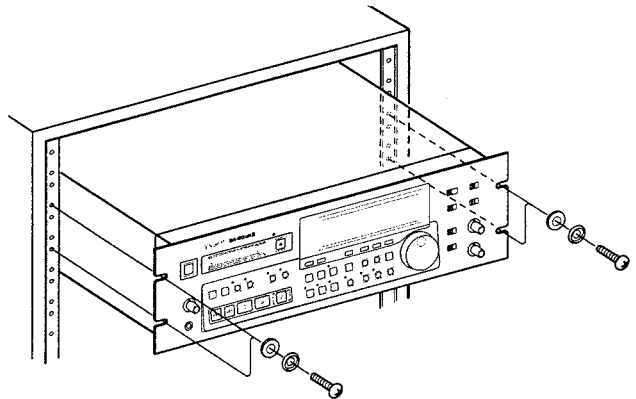

Care of the DA-60 MKII

- Be careful not to drop your deck or don't subject it to severe impact, especially during recording.
- When cleaning the exterior of the deck, use a soft cloth. If necessary, moisten a soft cloth with mild solution of detergent and water. Do not use any type of solvents such as alcohol or benzine.

Table of Contents

<p>Important Safety Precautions 2</p> <p>Safety Instructions 3</p> <p>Section 1 : Introduction 1 • 1</p> <p>Section 2 : Features and Controls..... 2 • 1</p> <p> 2-1. Front panel 2 • 2</p> <p> 2-2. Rear panel 2 • 5</p> <p> 2-3. Pin Assignment 2 • 6</p> <p>Section 3 : DAT Cassette Tape..... 3 • 1</p> <p> 3-1. How to Handle a DAT Cassette 3 • 1</p> <p> 3-2. Structure of DAT Cassettes 3 • 1</p> <p>Section 4 : Hookup Examples..... 4 • 1</p> <p> 4-1. Connection to Analog Equipment..... 4 • 1</p> <p> 4-2. Connection to External Digital Equipment to Make a Digital Copy 4 • 1</p> <p>Section 5 : Initial Settings 5 • 1</p> <p> 5-1. Selecting a Record/Write Mode 5 • 1</p> <p> 5-2. Selecting a Sampling Frequency 5 • 1</p> <p> 5-3. Selecting Analog or Digital Input 5 • 2</p> <p> 5-4. Selecting a Copy ID 5 • 2</p> <p> 5-5. Selecting a Sync Signal 5 • 3</p> <p> 5-6. Pre-emphasis On/Off..... 5 • 4</p> <p>Section 6 : Recording Audio Input..... 6 • 1</p> <p>Section 7 : Striping a Tape with Timecode 7 • 1</p> <p> 7-1. Getting Ready to Record Timecode 7 • 1</p> <p> 7-2. Striping Timecode using the Internal Generator 7 • 3</p> <p> 7-3. Copying Timecode from External Units 7 • 4</p> <p> 7-4. Recording ABS (Absolute) Time 7 • 7</p> <p>Section 8 : Playback 8 • 1</p> <p> 8-1. Selecting a Playback Timecode Reference 8 • 1</p> <p> 8-2. Playback 8 • 2</p> <p>Section 9 : Recording Sub-code Data..... 9 • 1</p> <p> 9-1. About DA-60 MKII Sub-codes..... 9 • 1</p> <p> 9-2. Recording/Erasing Start IDs 9 • 1</p> <p> 9-3. Program Numbers 9 • 3</p> <p> 9-4. Renumbering Program Numbers 9 • 3</p> <p> 9-5. Recording/Erasing an End ID 9 • 4</p> <p>Section 10 : Autolocation Functions..... 10 • 1</p> <p> 10-1. Setting Locations 10 • 1</p> <p> 10-2. Autolocating to MEMO Points 10 • 1</p> <p> 10-3. Locating to a Start ID 10 • 1</p> <p> 10-4. Program Number Search..... 10 • 2</p>	<p>Section 11 : Memory Start Operations..... 11 • 1</p> <p> 11-1. To Store Audio into a Memory Buffer..... 11 • 1</p> <p> 11-2. To Audition the "Buffered" Audio..... 11 • 1</p> <p> 11-3. To Trim Your Memory Start Point..... 11 • 1</p> <p> 11-4. Auto Cue Trigger Level 11 • 2</p> <p> 11-5. Executing a Memory Start Play 11 • 2</p> <p>Section 12 : Punch In and Out..... 12 • 1</p> <p> 12-1. To Select a Crossfade Time 12 • 1</p> <p> 12-2. Automatic Insertion 12 • 1</p> <p> 12-3. Manual Punch In and Out 12 • 2</p> <p>Section 13 : Fade In and Out..... 13 • 1</p> <p> 13-1. Setting the Fade In/Out Time..... 13 • 1</p> <p> 13-2. The Fade In Function..... 13 • 1</p> <p> 13-3. The Fade Out Function 13 • 2</p> <p>Section 14 : Play at Variable Speeds 14 • 1</p> <p> 14-1. To Change the Pitch..... 14 • 1</p> <p> 14-2. Cancelling the Variable Speed Mode..... 14 • 1</p> <p> 14-3. Checking the Current Pitch..... 14 • 1</p> <p>Section 15 : Slaving to External Machines 15 • 1</p> <p> 15-1. Hookup Examples..... 15 • 1</p> <p> 15-2. Setting-up the DA-60 MKII 15 • 1</p> <p> 15-3. Synchronization 15 • 3</p> <p> 15-4. Syncing with an Offset 15 • 4</p> <p> 15-5. Auto Offset Entry 15 • 4</p> <p> 15-6. Punch In and Out while Syncing 15 • 5</p> <p> 15-7. Slaving to a Video Picture 15 • 6</p> <p>Section 16 : Operations Conforming to P2 Protocol 16 • 1</p> <p> 16-1. Initial Settings..... 16 • 1</p> <p> 16-2. Memory Jog..... 16 • 2</p> <p>Section 17 : Lists of Menus..... 17 • 1</p> <p>Section 18 : Error Messages Explained..... 18 • 1</p> <p>Section 19 : Specifications 19 • 1</p> <p>Section 20 : Optional Features of Reference Level 20 • 1</p>
--	--

Important (for U.K. Customers)

DO NOT cut off the mains plug from this equipment. If the plug fitted is not suitable for the power points in your home or the cable is too short to reach a power point, then obtain an appropriate safety approved extension lead or consult your dealer.

If nonetheless the mains plug is cut off, remove the fuse and dispose of the plug immediately, to avoid a possible shock hazard by inadvertent connection to the mains supply.

If this product is not provided with a mains plug, or one has to be fitted, then follow the instructions given below:

IMPORTANT: The wires in this mains lead are coloured in accordance with the following code:

GREEN-AND-YELLOW	: EARTH
BLUE	: NEUTRAL
BROWN	: LIVE

WARNING: This apparatus must be earthed.

As the colours of the wires in the mains lead of this apparatus may not correspond with the coloured markings identifying the terminals in your plug proceed as follows:

The wire which is coloured GREEN-and-YELLOW must be connected to the terminal in the plug which is marked by the letter E or by the safety earth symbol \perp or coloured GREEN or GREEN-and-YELLOW.

The wire which is coloured BLUE must be connected to the terminal which is marked with the letter N or coloured BLACK.

The wire which is coloured BROWN must be connected to the terminal which is marked with the letter L or coloured RED.

When replacing the fuse only a correctly rated approved type should be used and be sure to re-fit the fuse cover.

IF IN DOUBT — CONSULT A COMPETENT ELECTRICIAN.

Head Drum Replacement

TASCAM recommends that you replace the head drum after every about 1,000 hours of operation for quality recording and playback. When 1,000 hours more or less are shown at a "2 Hour" menu, contact TASCAM or you nearest TASCAM dealer.

Voltage Conversion (General Export Models Only)

NOTE

Voltage conversion is not possible on models sold in the U.S.A., Canada, U.K., Australia or Europe.

For general export models only, if the input voltage specified on the machine, power cord tag, or packing carton differs from the line voltage at the installation site, first make sure that AC power cord is disconnected, then locate the voltage selector on the rear panel (figure below), and turn the selector using an appropriate screwdriver until the required voltage appears.

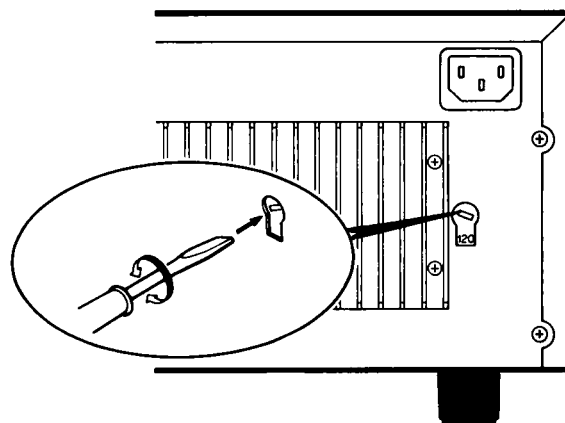

Optional Accessory

RC-D6 Remote Control Unit

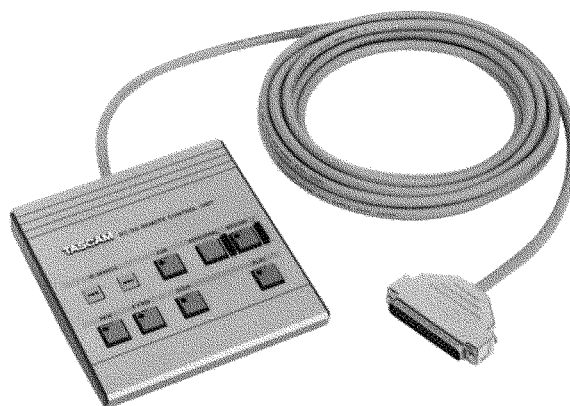

SECTION 2 : FEATURES AND CONTROLS

Front Panel

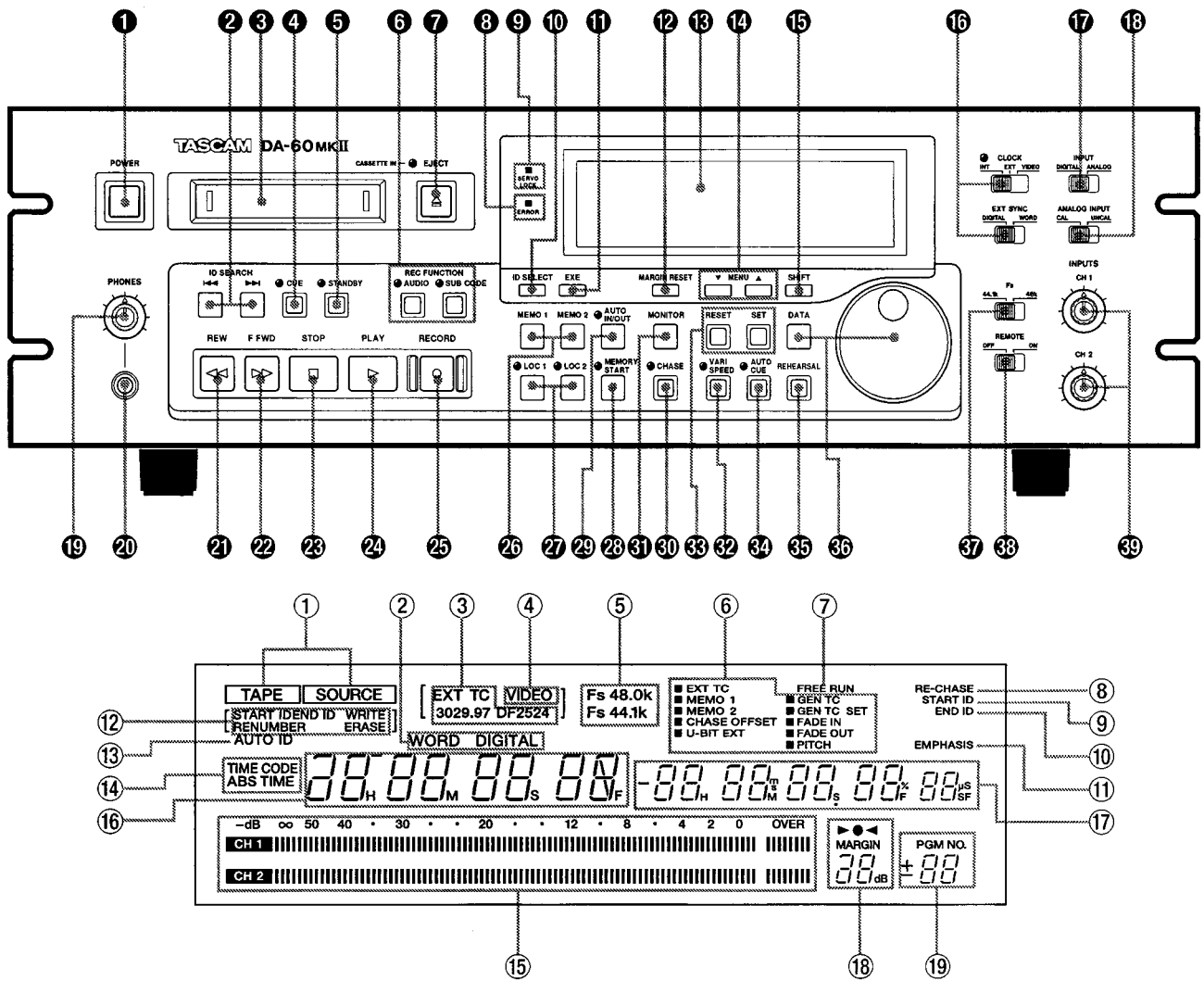

Rear Panel

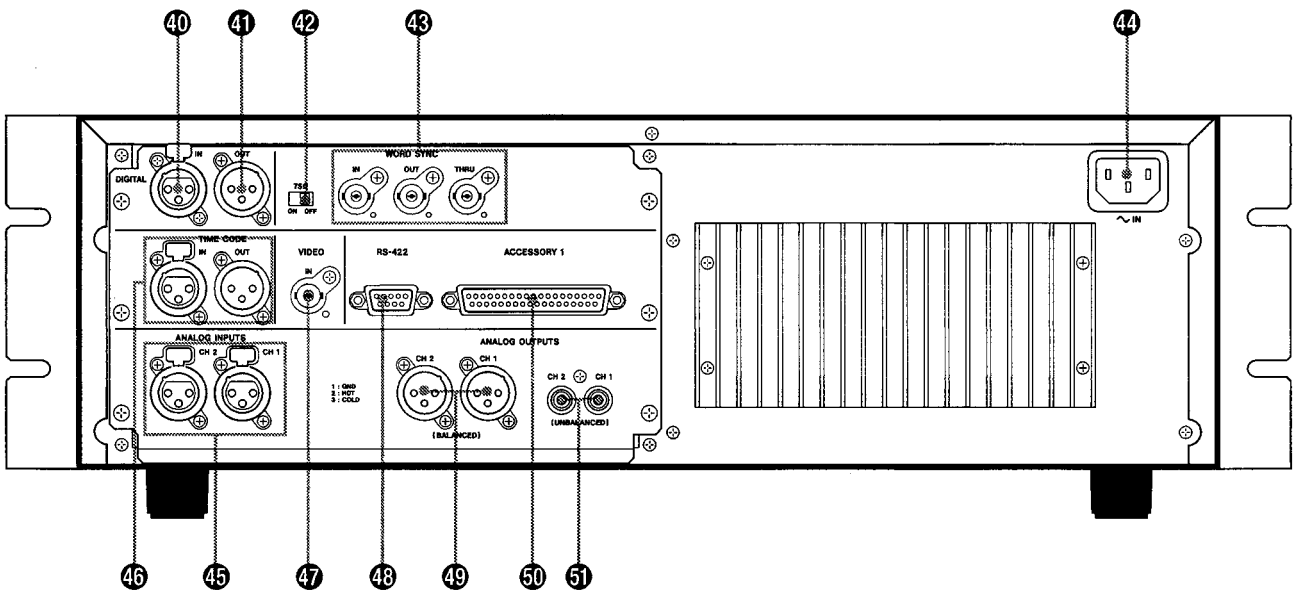

Skimming through this section of the manual will allow you to get an overview of the DA-60 MKII. It is not necessary to memorize all of what is here nor to try to understand all details to get started.

2-1. Front Panel

① POWER switch

Controls the power to the DA-60 MKII. Turning off power does not reset your settings at menus. The on/off state of the MEMORY START (item 28) and AUTO CUE (item 34) functions is or is not saved, as selected at a menu.

② ID SEARCH keys

Can operate during play or stop, and have the tape locate to the next or the previous Start ID mark. The transport will go into Standby mode at the end of search operations.

③ IDCassette loading slot

④ CUE switch

When pressed, it causes the deck to be ready for review or cueing, waiting for you to press F.FWD or REW. When either of these is pressed the first time, the PLAY button will light, also the fast wind button pressed, and you can hear the tape at about 1 time normal play speed. A second press, causes the tape to play at about 3 times normal play speed. A third press, speeds up to about 9 times normal play speed.

Pressing PLAY during CUE mode slows the tape down to the normal play speed. Pressing CUE again disables the mode.

⑤ STANDBY switch

STANDBY is a mode in which, if the tape is not running, the head drum is spinning. This ensures a tight start of play (or record).

Initiating PLAY, F.FWD or REW automatically causes the STANDBY LED to turn on, showing that the head drum will go into STANDBY mode when you press STOP.

To disable STANDBY mode, press the switch again.

If left in STANDBY mode for about 3 minutes, the deck will automatically exit the mode to avoid head wear.

⑥ REC FUNCTION switches

Offer three record/write modes, as discussed later (p. 5 • 1)

⑦ EJECT Key

Used to remove the cassette tape.

⑧ ERROR indicator

Lights during play when errors occur in the digital data at so excessive rates that they cannot be corrected and are submitted to interpolation to arrive at an approximation to the correct data.

⑨ SERVO LOCK indicator

Lights when the tape is correctly running, or when the master and slave transports are locked in sync.

⑩ ID SELECT switch

Each time this switch is pressed the following modes are selected in sequence, as shown in the display :

1. START ID WRITE (in ASSEMBLE or EDIT SUB mode)
2. START ID ERASE (in EDIT SUB mode)
3. END ID WRITE (in ASSEMBLE mode)
4. RENUMBER (in EDIT SUB mode)

Pressing the next EXE key executes selected operations.

⑪ EXE key

Used to execute operations selected by the ID SELECT switch.

⑫ MARGIN RESET key

Defeats a MARGIN (headroom available) indication so new readings can be taken.

⑬ Display window

Provides various information and messages, keeping you aware of what is currently taking place.

① **Monitor Source : TAPE** lights to show that the audio outputs and the meters are fed on tape signal. **SOURCE** lights when the monitor is switched to the input.

② **Sync Signal : WORD** will light when the deck is referenced to the Word Sync input. **DIGITAL** will light to show that the deck is referenced to the clock derived from the digital in.

③ **Time Code In : EXT TC** lights when time codes are being fed into the deck from the exterior. The type of time code selected at a "22 rEFtc" menu is also shown.

④ **Video/Film In : VIDEO** lights when the clock derived from the video in.

⑤ **Sampling Frequency** : Either indication lights when recording from analog input, as optionally selected ; or, when recording from digital input or during play, the sampling frequency at which the original recording was made will show.

- ⑥ **Menu Items and Variables** : Menus, and options available at them, are shown here. For more information, see Section 17, List of Menus.
- ⑦ **FREE RUN** : Blinks when the timecode generator is in the corresponding mode. See page 7 • 3 for an explanation.
- ⑧ **RE-CHASE** : Lights when this unit is used as a slave machine and is in the corresponding mode. For more information, see page 15 • 2.
- ⑨ **START ID** : Lights each time a Start ID mark is encountered.
- ⑩ **END ID** : Lights when an End ID mark is encountered.
- ⑪ **EMPHASIS** : Lights during both the pre-emphasis and the de-emphasis process.
- ⑫ **Subcode Edit Mode Indications** : The following are lit in sequence as you press the ID SELECT switch :
 - START ID WRITE** : Shows that you can write Start ID marks manually (in ASSEMBLE or EDIT SUB mode).
 - START ID ERASE** : Shows that you can erase Start ID marks (in EDIT SUB mode only).
 - END ID WRITE** : Shows that you can mark the end of audio recordings with End ID (in ASSEMBLE mode only).
 - RENUMBER** : You have to let this indication light when renumbering programs on tape (in EDIT SUB mode).
- ⑬ **AUTO ID** : Lights when recording of Start ID is automated.
- ⑭ **Time Indicators** : **TIME CODE** lights when professional DAT timecode is being converted to SMPTE/EBU timecode. When ABS time is being converted to SMPTE/EBU timecode, both the **TIME CODE** and the **ABS TIME** indicators are lit.
- ⑮ **Peak Level Meters** : If inputs overreach the meter scale, the red OVER indicator comes on. You can select a peak-hold mode at a menu, and also the release time of readings.
- ⑯ **Time Readout (left)** : Shows timecode numbers or menus. For details of the menus, see Section 17.
- ⑰ **Time Readout (right)** : Shows your settings at menus or locating time points.

⑱ **MARGIN indicator**

This is a digital peak-hold meter, showing the available headroom before digital saturation is reached and distortion occurs. It holds the highest reading since MARGIN RESET was last pressed (or since a new tape has been loaded). Readings range from 39 dB down to 0 dB (in 1 dB steps). If you have "1 Audio" (page 17 • 1) show on the left hand side of the display, the "●" indicator will light at the reference margin of "16 dB"; and at higher readings the "◀" indicator will light, and at lower readings the "▶" indicator will light.

- ⑲ **PGM NO.** : Shows (1) program numbers (if available) as the tape runs; (2) how many times you have pressed the ID SEARCH key to locate the tape to the Start ID mark of a program (p.10 • 1) ; and (3) frame numbers when trimming a MEMORY START point (p.11 • 1).

⑭ **MENU key**

Used to access menus. Depending on menus, you have to press SHIFT at the same time, as discussed later.

⑮ **SHIFT key**

Used together with the MENU key (or with the DATA dial) to access menus or to make your selections at them.

⑯ **CLOCK and EXT SYNC select switches**

Used to select a signal to which the DA-60 MKII is referenced for synchronization. See page 5 • 3 for details.

⑰ **INPUT select switch**

Used to select either the digital input or the analog input as the source of the DA-60 MKII.

⑱ **ANALOG INPUT select switch**

Determines whether the analog input passes through the level controls before reaching the tape and the output.

☞ This switch has effect only when the INPUT source select switch is set to the right/ANALOG position, and the monitor is switched to the input, as confirmed by the "SOURCE" indication being lit in the display.

CAL : The CH 1 and CH 2 INPUTS level controls are bypassed and the input level is passed to the output without receiving any level alteration. This CAL position is generally used for system calibration (level alignment). When a nominal level input is fed in, the level meter will read -16 dB. The nominal output level is +4 dBm at the balanced XLR-type connectors, and -10 dBV at the unbalanced RCA jacks.

UNCAL : The INPUTS level controls can operate.

SECTION 2 : FEATURES AND CONTROLS

19 PHONES control

Used to adjust the listening level in the headphones plugged into the jack just below.

20 PHONES jack

For connection of stereo headphones.

CAUTION

Don't connect a 2-conductor mono plug to this jack which will short out one of the amplifiers feeding the headphones, causing it burn out.

21 REW button

Winds the tape at high speed in reverse. If pressed when the CUE indicator lights, you can hear it play at high speeds. See also item 4.

22 F.FWD button

Similar to REW, but winds the tape in the forward direction.

23 STOP button

Disables the current transport mode and stops any tape motion. A STANDBY feature is then automatically activated and the head drum continues to spin for the resumption of play (or record) to be instantaneous.

24 PLAY button

Enables play mode. If REC FUNCTION is in EDIT AUDIO mode, and recording is taking place, pressing PLAY punches out of record.

The PLAY button automatically lights when F.FWD or REW is pressed after CUE (item 4).

25 RECORD button

When pressed together with PLAY, enables record mode. When the deck is in EDIT AUDIO mode and is playing, it will drop into record upon hitting RECORD.

26 MEMO 1 and MEMO 2 keys

Used to set locations to which the deck will be auto-located when you press the LOC 1/2 key. Setting MEMO points at menus is explained in Section 10, page 10 • 1.

MEMO points can be fine tuned within 30 frames behind or ahead of the original point, as explained in Section 11, pages 11 • 1 and 2.

Turning off the deck does not clear MEMO points from memory.

27 LOC 1 and LOC 2 keys

Used to autolocate the deck to the MEMO 1 and 2 points, respectively.

28 MEMORY START key

This ensures instant transition from Stop to Play. When you press this key and locate the tape to the point where you want to let play start from, the first 3 seconds of digital audio are stored into a memory buffer ; so that, when you hit PLAY, audio is read from the memory instead of directly from the tape and there can be no delay between the time you hit PLAY and hear audio. See Section 11 for more information.

29 AUTO IN/OUT switch

Causes the deck to drop into record at the MEMO 1 point, and drop out of record at the MEMO 2 point. See pages 12 • 1 and 15 • 5 for details.

30 CHASE key

When this is pressed on, the DA-60 MKII constantly compares the timecode read off tape with the incoming timecode so that the deck operates in sync with external machines.

The DA-60 MKII offers two sync modes:

(1) Re-chase mode : In this mode, two timecodes, one from the master and one from a slave, are compared constantly, and each time the slave advances or delays with respect to the master, the slave is made to speed up or slow down to keep up with the master.

(2) Free run mode : In this mode, the slave chases and locks to the master only once ; thereafter the slave does not respond to the master and operates independently.

31 MONITOR select switch

This switch toggles between two monitoring options : TAPE and SOURCE, switching the headphones output, and also both the digital and analog outputs, to the tape or to the input.

32 VARI SPEED switch

Pressing this switch allows you to use the rotary dial to change the tape speed. See page 14 • 1 for details.

33 SET and RESET keys

SET is used to save your settings at menus, and RESET is used to cancel your settings.

34 AUTO CUE switch

Automatically cues the deck to "first frame of audio" (or the very fast musical note) in a program. See page 11 • 2 for details.

③ REHEARSAL key

Used when a trial punch in is required without actually recording on to tape (page 12 • 2). Also used for a trial Memory Start (page 11 • 1).

④ DATA switch and rotary dial

Used to select parameters from menus. Also, rotating the dial while holding SHIFT scrolls the menus.

☞ While the VARY SPEED LED is on, the rotary dial is used to increase or decrease the play speed.

⑤ Fs (sampling frequency) select switch

Selects a sampling frequency when recording from analog input.

⑥ REMOTE switch

Setting this switch to OFF selects the ACCESSORY 1 parallel data port for interface to external systems ; and setting to ON selects the RS-424 serial data port, instead.

NOTE

Setting the switch to ON disables all the controls on the DA-60 MKII.

⑦ INPUTS level controls

Can operate only when the INPUT source select switch is at ANALOG position and the ANALOG INPUT switch (item 18) is at UNCAL position.

2-2. Rear Panel

⑧ DIGITAL IN

For connection to the XLR digital audio output of external equipment. Either the AES/EBU format data (IEC 958 TYPE I) or a consumer format data (IEC 958 TYPE II) can be plugged in ; the deck configures itself for the type of incoming data.

⑨ DIGITAL OUT

For connection to the XLR digital input of external equipment. Only the AES/EBU format data is available at this output.

⑩ 75 ohm ON/OFF switch

Setting this switch to ON position disables the WORD SYNC THRU jack by terminating the WORD SYNC IN jack in 75-ohm resistor. When using the THRU jack, set the switch to OFF position.

⑪ WORD SYNC jacks

Used for the deck to operate in sync with external machines by referencing to the Word Sync signal.

The IN signal is "echoed" out the THRU jack unless the 75 ohm switch is at ON. The THRU jack may be connected to a second slave machine.

⑫ AC IN

For connection of a supplied AC power cable.

⑬ ANALOG INPUTS

These XLR-type connectors accept balanced signals from external units.

Pin assignment : Pin 1 shield (GND), Pin 2 hot (+), and Pin 3 cold (-).

⑭ TIME CODE IN and OUT

For receiving and transmitting SMPTE/EBU timecodes.

⑮ VIDEO IN

Accepts a video composite or film sync signal from VTRs or film editing machines to which the DA-60 MKII will be slaved.

⑯ RS-422 port

This 9-pin D-sub connector is for serial interface to computers or controllers. The pin assignment is shown on the next page.

⑰ ANALOG OUTPUTS (XLR-type connectors)

For connection to the balanced analog input of external units.

Pin assignment : Pin 1 shield (GND), Pin 2 hot (+), and Pin 3 cold (-).

⑱ ACCESSORY 1 port

This 37-pin D-sub connector is for parallel interface to the optional remote control RC-D6, or to computers or others. The pin assignment is shown on the next page.

⑲ ANALOG OUTPUTS (RCA jacks)

For connection to the unbalanced input of external units, including monitor systems.

SECTION 2 : FEATURES AND CONTROLS

2-3. Pin Assignment

● ACCESSORY 1 Port

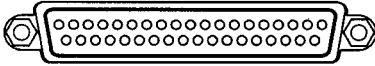

Pin	Signal
1	PLAY IN
2	F.FWD IN
3	REW IN
4	REHEARSAL IN
5	STOP IN
6	REC IN
7	CUE IN
8	FADER START IN
9	—
10	—
11	PLAY OUT
12	F.FWD OUT
13	REW OUT
14	STOP OUT
15	REC OUT
16	CUE OUT
17	START - ID OUT
18	—
19	STAND BY OUT
20	END OF TAPE OUT
21	—
22	START - ID WRITE IN
23	ID SEARCH NEXT IN
24	ID SEARCH PREVIOUS IN
25	—
26	—
27	—
28	—
29	—
30	—
31	—
32	—
33	—
34	—
35	—
36	GND
37	+5V

● RS-422 Port

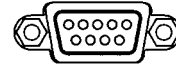

Pin	Signal
1	FRAME GROUND
2	TRANSMIT A
3	RECEIVE B
4	TRANSMIT COMMON
* 5	BRAKE
6	RECEIVE COMMON
7	TRANSMIT B
8	RECEIVE A
9	FRAME GROUND

*) Pin 5 is used only when connecting to the TASCAM ES-61 edit controller.

• **Input** : To activate a function, the pin must be brought to ground potential for 50 msec or more.

Pin 8: FADER START



• **Output** : Open collector. Maximum allowable current 100 mA
+5V supply : Maximum allowable current 0.3 A.

SECTION 3 : DAT CASSETTE TAPE

3-1. How to Load a DAT Cassette

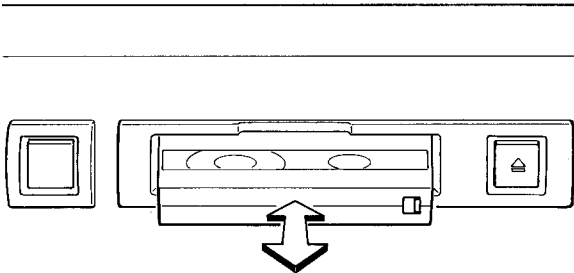

☞ Only when the DA-60 MKII is turned on, you can load DAT tapes.

The hinged part of the cassette must go in first, with the clear window facing up. Similar to a VCR tape, the label surface of the cassette will be visible. When you encounter a slight bit resistance, push the cassette gently.

When a cassette is loaded, the CASSETTE IN LED will glow solid. This indicator will blink when you press EJECT, and will turn off when the cassette is ejected.

NOTES

- Cassette shells are designed so as to prevent touching the tape directly by hand.
- DAT cassettes can be loaded and unloaded only when the DA- 60 MKII is switched on.
- DAT cassettes record and play in one direction only. Do not load DAT cassettes upside down.
- DAT cassettes have a tape protection lid on the front edge to protect the tape. Do not open this lid forcibly, and do not pull the tape out from the cassette or touch it with your fingers.
- Be sure to replace DAT cassettes in their plastic cases for storage.
- Do not place DAT cassettes on a television, speaker or near equipment which could generate a magnetic field.

Don't use 180-minute cassettes in the DA-60 MKII
The tape used in 180-minute cassettes is extremely thin and can cause winding problems, crimping, wrinkling, and other damage to data on tape.

3-2. Structure of DAT Cassettes

Bottom view

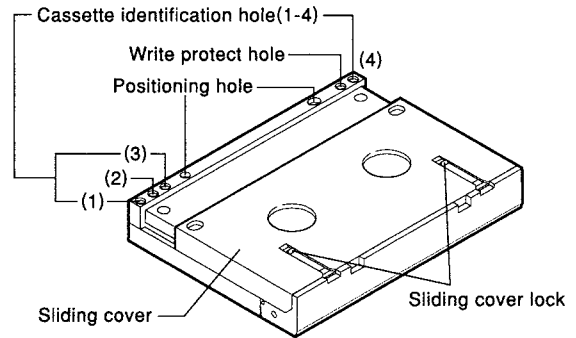

Identification Hole			Signified
1	2	3	
X	X	X	Metal coating or equivalent/ 13 μm tape thickness
X	○	X	Metal coating or equivalent/ Thin tape
X	X	○	1.5 time track pitch/13 μm tape thickness
X	○	○	1.5 time track pitch/Thin tape
○	—	—	(Reserved for auxiliary tape type definitions)

Where : "○" = Open
"X" = Closed

Identification Hole 4

○ = Pre-recorded tape sold by record companies
X = Blank tape

Top view

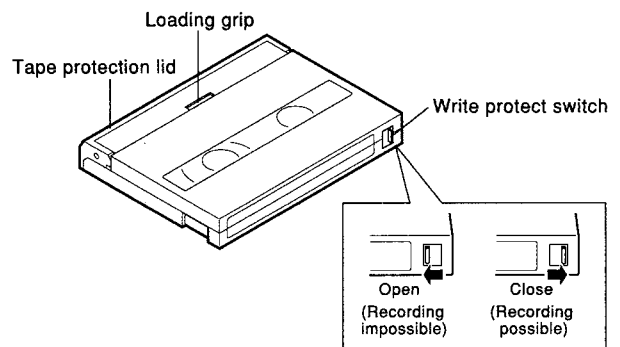

- Dimensions: 73 x 54 x 10.5 mm(W x D x H)
- Tape width: 3.81 mm

SECTION 4 : HOOKUP EXAMPLES

This section of the manual is only intended to provide basic hookup examples for you to get an idea of what you will need for your particular setup.

4-1. Connection to Analog Equipment

■ Example : Recording and Playing Analog Audio Signals

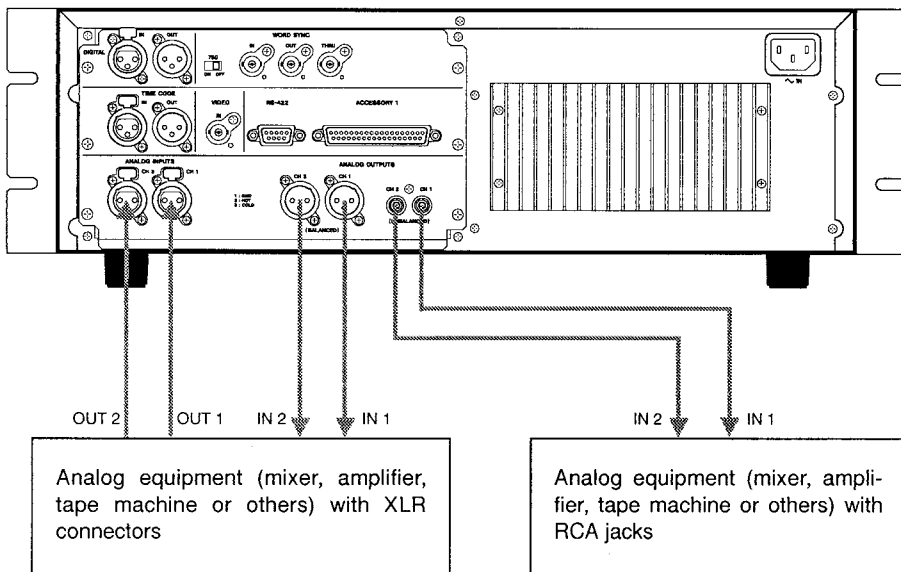

The INPUT switch should be set to ANALOG.

4-2. Connection to External Digital Equipment to Make a Digital Copy

■ Example 1 : Using the DA-60 MKII as the Target Machine

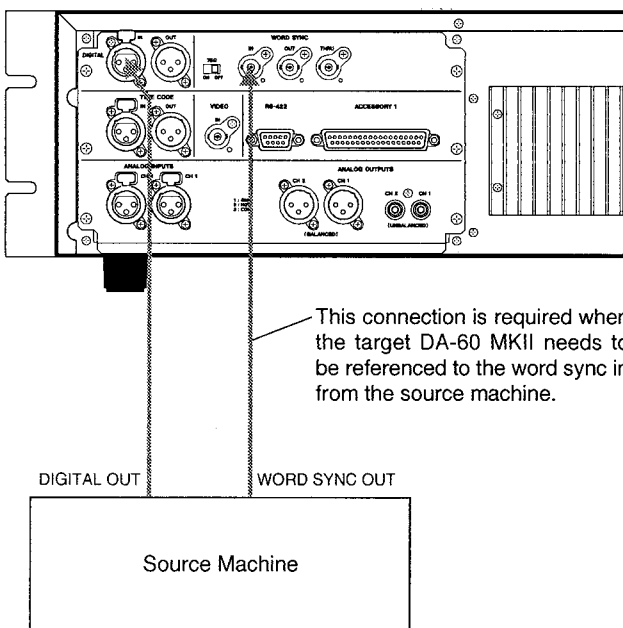

This configuration requires the following switch settings (on the front panel) :

- INPUT switch to DIGITAL ;
- CLOCK switch to EXT ;
- EXT SYNC switch to DIGITAL, or to WORD, depending on the clock to which the source machine is referenced.

The DA-60 MKII is slaved to the clock derived from the digital in, or from the word sync in, and receives digital signal from the digital in.

■ Example 2 : Using the DA-60 MKII as the Source Machine

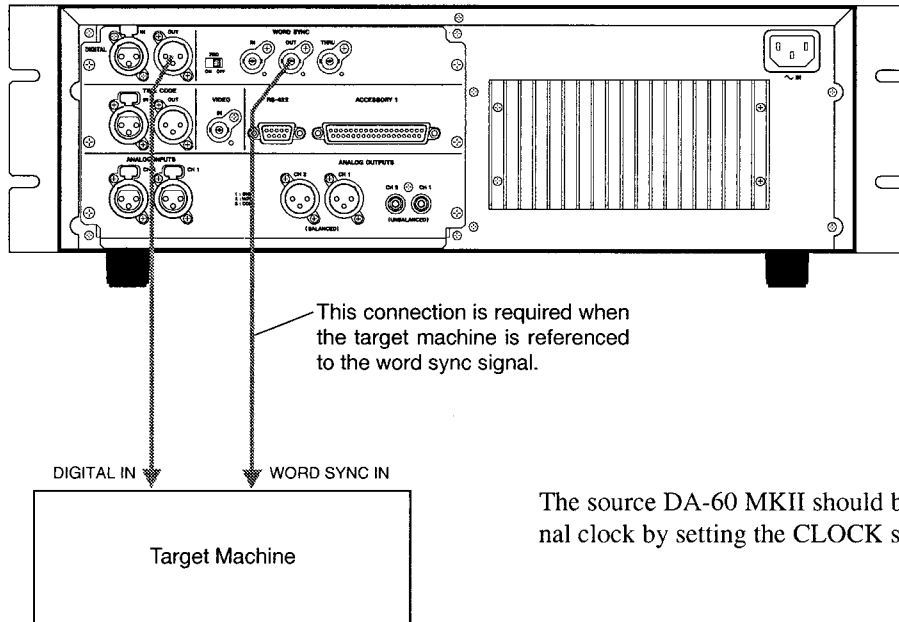

The source DA-60 MKII should be referenced to its internal clock by setting the CLOCK switch to INT.

NOTE

When making a digital copy, remember the following :

The digital output carries AES/EBU format data (IEC958 Type I), and whatever is written in the subcode area of the tape is NOT sent out.

If you want to copy Start IDs along with audio, connect the Start ID output available at pin 17 of the ACCESSORY 1 (D-sub, 37-pin) connector to Start ID input pin 22 of the identical connector on the target DA-60 MKII, or to an equivalent input if any other recorder is used as the target machine.

SECTION 5 : INITIAL SETTINGS

Before starting recording, you have to perform the following settings.

5-1. Selecting a Record/Write Mode

The DA-60 MKII offers three record/write modes : ASSEMBLE, EDIT AUDIO, and EDIT SUB.

ASSEMBLE mode allows both audio and subcode data to be recorded at one time. Use this mode when you are using a new blank tape.

☞ ABS time is automatically recorded. Recording of Start and End IDs is up to you (discussed later).

EDIT AUDIO mode which allows you to edit audio data previously recorded in ASSEMBLE mode. The existing subcode data is not affected. This mode is typically used for punching in and out.

EDIT SUB mode allows only subcode data to be edited.

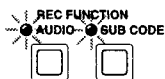

To select ASSEMBLE mode, press AUDIO and/or SUB CODE of REC FUNCTION so that both LEDs turn on.

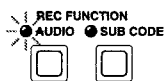

To select EDIT AUDIO mode, press AUDIO and/or SUB CODE so that the AUDIO LED turns on and the SUB CODE LED turns off.



To select EDIT SUB mode, press AUDIO and/or SUB CODE so that the SUB CODE LED turns on and the AUDIO LED turns off.

5-2. Selecting a Sampling Frequency



If you intend to record analog inputs on a new tape, set the Fs switch to the left 44.1 k position for CD production, or set to the right 48 k position for other applications.

This setting is required only when recording from the analog input. The DA-60 MKII configures itself for the correct sampling frequency when editing audio data previously recorded, recording from the digital source, or playing back a tape.

NOTE

To insure against any trouble caused by coexistence of different sampling rate information on a tape, if you want to use an old tape and overwrite whatever is previously recorded, erase the tape from start to end using a metal-tape bulk eraser.

If an appropriate eraser is not available, use this alternative way :

Immediately after inserting the tape into the DA-60 MKII, press and hold STOP until the button lights, so the deck cannot read sampling rate information from the tape, and recording can be made at a sampling rate you select with the Fs switch.

5-3. Selecting Analog or Digital Input



Depending on the source connection, set the INPUT switch to DIGITAL or to ANALOG.

If you select the digital input, the indicator "DIGITAL" will light up on the display when a digital signal is actually fed in.

The DA-60 MKII can accept both the AES/EBU and consumer format data, configuring itself for an incoming format of data.

5-4. Selecting a Copy ID

Copy ID is the flag which determines how many generations of copy you can add to the original digital recording. (This ID is written to ID6 in the main data area of the tape.)

This setting is required and valid only when recording consumer format digital data following the SCMS (Serial Copy Management System).

To Select a Copy ID

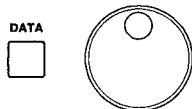
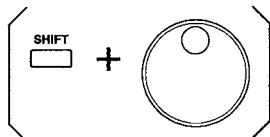
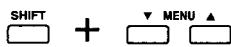

1 Hold SHIFT and press MENU until the menu "4 coPy" shows on the left hand side of the display.

4 coPy id-6 00

Suggestion : An alternative is to rotate the DATA dial while holding SHIFT.

2 Press DATA, and rotate the dial. The blinking number will change as follows :

- id-6 00 : Indefinite number of generations of copy can be added.
- id-6 10 : No digital copy can be made.
- id-6 11 : Only one generation can be added. To make a copy of a copy is impossible.

3 Press SET to save your selection.

To switch the display back to show timecode numbers, press either MENU key.

- The above setting has nothing to do with recording/copying AES/EBU format

SECTION 5 : INITIAL SETTINGS

5-5. Selecting a Sync Signal

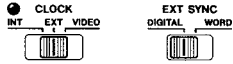

To let the DA-60 MKII play or record in sync with other digital audio machines, it must be referenced to an incoming clock.

Depending on the clock to which the DA-60 MKII is to be referenced, set the CLOCK and the EXT SYNC switches as follows :

CLOCK	EXT SYNC	S2 (see page 7•2)	Indication	Referenced to
INT	—	—	INT LED*	Internal clock
EXT**	DIGITAL	—	DIGITAL	Clock derived from the digital in (INPUT switch at DIGITAL)
	WORD	—	WORD	Clock derived from the word sync in
VIDEO	—	VIDEO	VIDEO	Clock derived from the video composite signal coming into the video in
	—	FILM	VIDEO	Film sync signal coming into the video in

* The INT LED will light when :

- 1) the CLOCK switch is set to INT and the clock is correctly being generated OR
- 2) although the CLOCK switch is set to EXT or to VIDEO, the clock is not coming in, and the internal clock is activated instead.

** When the DA-60 MKII is in play mode and is referenced to an external clock (either derived from the digital in or from the word sync in), a maximum of +/- 12.5% speed variation on external transports does not release the sync lock.

When recording onto the DA-60 MKII, you can select either the limits of +/-100 ppm or of +/-12.5% at a menu ("14 bAnd"), as discussed later, page 17 • 4.

5-6. Pre-emphasis On/Off

This setting is required only when recording analog audio inputs.

The DA-60 MKII converts analog signals into digital format, and records encoded signals (a series of numbers) on tape. Before converted into digital format, analog signals are pre-emphasized to boost high frequencies ; and during play these are cut (de-emphasized) to minimize high frequency noise, thus improving signal-to-noise ratio.

The DA-60 MKII has the capability of turning the emphasis circuit on or off to accommodate various situations. Your setting is recorded on tape along with audio data; and, playback is de-emphasized or not depending the setting recorded on tape.

To Switch the Pre-emphasis On or Off :

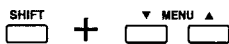

- 1** Hold SHIFT and press MENU until the menu "3 PrEEP" (pre-emphasis) shows on the left hand side of the display.

3 PrEEP oFF

- 2** Press DATA, and rotate the dial to change the blinking "oFF" to "on" or vice versa, as required.

- 3** Press SET to save your selection.

If you have selected "on", the display will show "EMPHASIS".

☞ There are more other menu-controlled functions. Set also them to meet your requirements by referencing to Section 17.

SECTION 6 : RECORDING AUDIO INPUT

If you want to perform a punch-in recording, go to the section on Punch In and Out, page 12 • 1.

Before initiating audio recording, consider the Subcode Data recording possibilities and limitations (discussed later).

1 Check that the following are correctly set as per instructions given in the previous section of this manual :

- (1) Record mode : Select the ASSEMBLE mode for recording on a new, blank tape.
- (2) Sampling frequency
- (3) Input source
- (4) Copy ID
- (5) Sync reference signal
- (6) Pre-emphasis

2 Set the recording level as follows :

- (1) Press MONITOR until "SOURCE" shows in the display. The audio outputs (Phones, Analog, and Digital) are now all switched to carry the input signal.
- (2) Set the ANALOG INPUT switch to UNCAL, and play the source and adjust the INPUTS level controls until the meters peak at "0".

In the CAL position a +4 dBm signal causes the meter to read -16 dB. The level controls have no effect on the reading.

3 Press MONITOR once more to have "TAPE" appear on the display so you can monitor recording off tape. The peak meter also then registers the level off tape, not the input level.

Or, leave MONITOR switched to SOURCE if you want to monitor the input signal.

In addition if the deck is in EDIT AUDIO mode, the monitor automatically switches to "SOURCE" when recording starts. And during recording you cannot switch it to the tape.

4 When everything is ready, press RECORD and PLAY together to start recording.

5 Press STOP to terminate recording.

The tape will automatically move backward over the length of about 1.5 seconds before stopping (this occurs only in ASSEMBLE mode) ; so that, when you start a new recording, there is no break in the sub-code data.

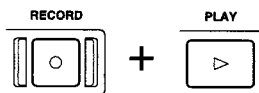

SECTION 7 : STRIPING A TAPE WITH TIMECODE

To have the DA-60 MKII sync up to other audio recorders or VTRs, the same type of timecode must be registered on their tapes. You can stripe timecode on a DAT tape either by using the internal timecode generator or by copying a timecode existing on an external tape. This unit converts timecode (whether it comes from the internal generator or an external tape) to professional DAT format and writes it in a sub-code (non-audio) area of the tape.

Precautions and Recommendations

- The same type of timecode must be recorded on both the master and slave tapes or else erratic synchronization and autolocation will occur.
- When recording program material, allow a sufficient leader tape ahead of each of them. Similarly, allow a sufficient length of no-audio section after the end of the last program on every tape.

7-1. Getting Ready to Record Timecode

Opening the menu "tc"

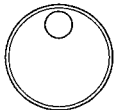
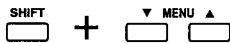

To access timecode-related menus you first have to open a "tc" menu.

- 1** Hold down SHIFT and press MENU until the menu "tc" appears on the left hand side of the display, which looks like this :

-tc- cLoSE

- 2** Press DATA. The "cLoSE" will start blinking.

- 3** Turn the rotary dial to change the "cLoSE" to "oPEn."

- 4** Press SET to save the setting.

From now on you can access any of the timecode-related menus at any time you need. They include the following menus that pertain to group 1 :

- EXT TC
- GEN TC
- GEN TC SET
- CHASE OFFSET
- U-BIT EXT
- U-BIT

See also Section 17.

SECTION 7 : STRIPING A TAPE WITH TIMECODE

Selecting a Type of Timecode

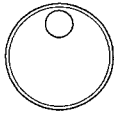
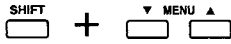

It is imperative that one and the same type of timecode is used throughout your system.

The DA-60 MKII is factory preset to 29.97 dF. To select other types of timecode :

1 Hold down SHIFT and press MENU until a "rEFtc" (reference timecode) menu appears on the left side of the display, which looks like this :

22 rEFtc 2997 dF

2 Press DATA. The "2997 dF" will start blinking.

3 Turn the rotary dial to select the desired type of timecode among the following (in addition to "2997 dF") :

- "30 ndF" (for SMPTE 30 non-drop frame code)
- "2997 ndF" (for SMPTE 29.97 non-drop frame code)
- "25 Ebu" (for EBU 25 frame code)
- "24 Fil" (for FILM 24 frame code)
- "30 dF" (for SMPTE 30 drop frame code)

4 Press SET to save your setting.

The associated indicator (30, 29.97, etc) will blink in the display if a different type of code from the one you just selected comes in from external units.

If you intend to slave the DA-60 MKII to a film sync signal (square wave, TTL level) plugged into the video input, dip- switches S-2 (located on the SYNC PC Board) must be set as follows :

	1	2	3	4	→	1	2	3	4
ON			-	-		ON	-		
OFF	-	-				OFF	-	-	-
	VIDEO SIGNAL					FILM SIGNAL			

WARNING

This setting must be done only by a qualified service person.

Selecting a Generator Mode

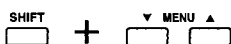

The internal timecode generator is factory preset to "rEc run" mode. To check or change the current generator mode :

1 Hold down SHIFT and press MENU until a "tcGEN" menu appears on the left hand side of the display, which looks like this :

24 tcGEN rEc run

Suggestion : Alternatively, you can hold SHIFT and press MARGIN RESET to access the "tcGEN" menu.



2 Press DATA. The "rEc run" will start blinking.

3 Turn the rotary dial and the following modes will show in sequence :

- rEc run : In this mode the internal timecode generator starts generating timecode from a user selected time point and recording it on tape when the transport enters either ASSEMBLE or EDIT SUB record mode.
- FrEE run : This mode is independent of transport mode, and upon selecting this mode the internal timecode generator immediately starts generating timecode from a user selected time point, as confirmed by the message "FREE RUN" being flashing.

To stop the generator, select any other mode than "FrEE run".

In "FrEE run" mode, timecode on tape cannot be played back.

You can view timecode numbers on the right hand side of the display as they are generated and recorded if you press MENU to have a "■ GEN TC" indicator appear.

- J-Sync (jam sync) : This mode is used to add timecode to the end of the prerecorded code on tape in such a way that there will be continuous, uninterrupted timecode on tape.
- oFF : Select this mode when recording timecode coming from the exterior on a DAT tape.

4 Press SET to save your setting.

7-2. Striping Timecode using the Internal Generator

From a user selected time point onward

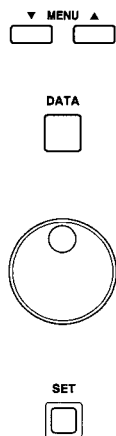

1 Make sure that "rEc run" is selected at the "24 tcGEN" menu, as discussed above.

2 Press MENU until "■ GEN TC SET" lights up in the display. Below the indicator will show the current start time.

3 Press DATA. The hour digits will start blinking.

Each time you press DATA, the next lower (right) two digits will blink.

4 When the digits you want to set are blinking, turn the rotary dial so that the desired number appears.

You can press RESET to clear the blinking digits to 00.

5 When you are satisfied with all the hour, minute, second and frame displays, press SET.

SECTION 7 : STRIPING A TAPE WITH TIMECODE

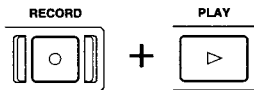

To Add Timecode to the End of the Prestriped Code

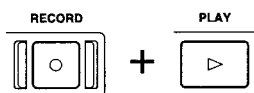

6 Enter the ASSEMBLE mode if you intend to record audio at the same time as timecode. Or, if you want to record timecode only, enter the EDIT SUB mode. Note, however, in EDIT SUB mode, timecode cannot be recorded on a non-recorded blank (neither audio nor sub-code data) section of the tape.

7 Hold RECORD and press PLAY to initiate timecode recording.

You can see timecode numbers as they are recorded on tape.

Suggestion : When recording timecode with the generator switched to its "rEc run" mode, the code is sent out of the TIME CODE OUT jack, allowing it to be recorded on external machines as well. But don't use this local striping capability with VTRs since the internal generator is not timed to coincide with rising edges of the video frame.

To record additional timecode on a tape which is previously striped with code up to an intermediate point, proceed as follows :

1 Select "J-Sync" mode at the "24 tcGen" menu.

2 Locate the deck to a point 2 seconds or more lower than the end of the existing code.

This is absolutely necessary for the deck to read the existing code and generate code starting from the correct number.

3 Enter the ASSEMBLE mode to record audio at the same time as timecode. Or, select the EDIT SUB mode to record timecode only. Speaking of remembering, in EDIT SUB mode, timecode cannot be recorded on a non-recorded blank (neither audio nor sub-code data) section of the tape.

4 Hold RECORD and press PLAY to let timecode recording start.

- If no timecode is prerecorded on the tape, the generator starts from a user selected time point overriding the J- Sync mode.

7-3. Copying Timecode from External Units

To record external timecode onto the DA-60 MKII, the internal generator must be in "oFF" position, as selected at the "24 tcGen" menu.

☞ You cannot copy timecode from ATRs onto the DA-60 MKII. If you want, you can copy only audio data from an ATR by letting it run in sync with the DA-60 MKII after having recorded timecode on the tape in the DA-60 MKII.

To Copy Timecode from VTRs

1 Check to see that both the DA-60 MKII and the VTR are turned off.

2 Make the following connections :

- Connect the timecode from the VTR to the TIME CODE IN jack on the rear of the DA-60 MKII.
- Connect composite video signal from a sync or pattern generator in use to the VIDEO IN jack on the rear of the DA-60 MKII.

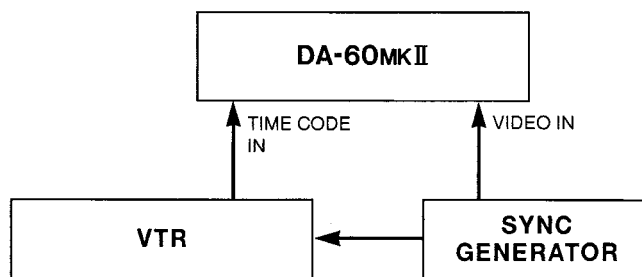

3 If you intend to copy both audio data and timecode at the same time (otherwise, skip to step 4) :

- Connect the audio output of the VTR to the DIGITAL IN or to the ANALOG INPUTS jacks on the rear of the DA-60 MKII depending on the audio output.
- Set the INPUT select switch to ANALOG or to DIGITAL depending on the connection.
- Set the CLOCK switch to EXT when copying from the digital input.

4 Turn on the DA-60 MKII, and also the VTR.

5 Set the CLOCK switch to VIDEO.

- To copy digital audio data at the same time as timecode, the switch must be set to EXT, as said in step 3.

6 Enter the EDIT SUB record mode.

- To copy audio data (digital or analog) at the same time as timecode, select the ASSEMBLE mode.

7 If your VTR has a variable speed function, check to see that it is disabled.

8 Put the VTR into play mode.

9 Put the DA-60 MKII into record mode by holding RECORD and pressing PLAY.

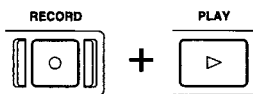
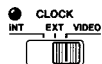

SECTION 7 : STRIPING A TAPE WITH TIMECODE

Copying Timecode from DTRs (Digital Tape Recorders)

- 1** Check to see that both the DA-60 MKII and the DTR are turned off.
- 2** Make the following connections :
 - Connect the timecode from the DTR to the TIME CODE IN terminal on the rear of the DA-60 MKII.
 - Connect the word sync out from the DTR to the WORD SYNC IN jack on the DA-60 MKII.

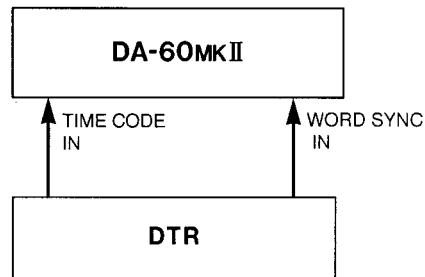

- 3** If you intend to copy audio data at the same time as timecode (otherwise, skip to step 4) :
 - Connect the audio output from the DTR to the DIGITAL IN jack on the DA-60 MKII.
 - Set the INPUT select switch to DIGITAL.
- 4** Turn on the DA-60 MKII, and also the DTR.
- 5** Set the CLOCK switch to EXT.
- 6** Set the EXT SYNC switch to WORD.
 - Only when your DTR has no word sync output, set the switch to DIGITAL so the DA-60 MKII can be referenced to the clock derived from the digital in.
- 7** Enter the EDIT SUB mode.
 - Or, select the ASSEMBLE mode to copy both audio and timecode at the same time.
- 8** If your DTR has a variable speed function, check to see that it is disabled.
- 9** Put the DTR into play mode.
- 10** Put the DA-60 MKII into record mode by holding RECORD and pressing PLAY.

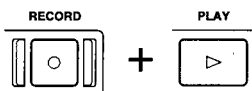
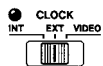

7-4. Recording ABS (Absolute) Time

ABS time indicates the total time elapsed from the beginning of the tape. It is registered automatically (in ASSEMBLE or in EDIT SUB mode), but be aware of the following points :

- When using an unrecorded, blank tape, be sure to rewind it all the way to the beginning before starting recording. Otherwise ABS time is not recorded.
- ABS time is sequentially recorded when the deck starts recording (in ASSEMBLE or in EDIT SUB mode) from a point where ABS time is already recorded. Even the EDIT SUB mode does not allow recording ABS time on a non-recorded blank section of the tape.
- During recording ABS time you can see it increment on the left hand side of the display if you select "AbS" at a "21 PbtC" menu.
- No ABS time is displayed during play.

SECTION 8 : PLAYBACK

8-1. Selecting a Playback Timecode Reference

During play the DA-60 MKII converts a professional DAT timecode or the ABS time data into SMPTE/EBU timecode. This conversion is controlled from a "21 Pbtc" menu. This menu offers three optional modes :

- "Auto" : In this mode the professional DAT timecode registered on tape or, if it is not available, the ABS time data is converted into SMPTE/EBU timecode.
- "tc" : This mode converts the professional DAT timecode into SMPTE/EBU timecode.
- "AbS" : This mode converts the ABS time data into SMPTE/EBU timecode.

The DA-60 MKII achieves such operations as autolocation and synchronization by referring to the thus converted SMPTE/EBU timecode, the type of which depends on your selection at the menu "22 rEFtc" (page 7 • 2).

- If the professional DAT format data on the tape originated from the 29.97 f/s time code (drop or non drop) and another type of SMPTE/EBU timecode is selected before play, then the display for timecode numbers could "jump" at the boundary of "0" hour or could read "24" hours or more. This is because of discrepancy between the timecode numbers and the actual time, and is not due to any trouble of the DA-60 MKII.
- Among consumer DAT recorders there are some which cannot record ABS time data correctly. If a tape recorded on such machines is loaded on the DA-60 MKII and the frame digits blink on the left side of the display, it shows that the ABS time data on the tape is not accurate enough for the correct synchronization or autolocation. If this is the case, record timecode afresh in EDIT SUB mode.

To select a playback timecode reference

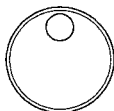
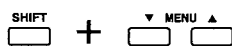

1 Hold down SHIFT and press MENU until a "21 Pbtc" menu shows on the left hand side of the display.

21 Pbtc Auto

2 Press DATA. The "Auto" will start blinking.

3 Turn the rotary dial to change the "Auto" to "tc" or to "AbS", as required.

4 Press SET to save your selection.

8-2. Playback

1 Press PLAY and playback starts.

- Upon pressing PLAY the monitor automatically switches to "TAPE".
- If STANDBY is pressed on, the head drum is in motion, so you'll hear audio immediately after hitting PLAY.

If leaving the deck in STANDBY mode for about 3 minutes, the mode is automatically cancelled to avoid tape and head wear.

- You can hear the tape play at high speeds if in CUE mode.
- During play the following will show on the display :
 - The current program number
 - Timecode numbers
 - EMPHASIS indicator (if the recording was emphasized)



2 To stop playback, press STOP.

SECTION 9 : RECORDING SUB-CODE DATA

9-1. About DA-60 MKII Sub-codes

DAT recorders are capable of recording sub-codes apart from the audio data. The DA-60 MKII can handle the following sub-code data :

- Start ID
- End ID
- Program Number
- ABS Time
- Professional DAT Timecode

9-2. Recording/Erasing Start IDs

Recording Start IDs

Start IDs are used to mark the beginning of a program or of a section, so that you can quickly move to any start point for play. They can be recorded automatically or manually.

NOTE

Any transport controls except for STOP cannot operate when a Start ID is being registered on tape.

Automatic Recording (along with Audio)

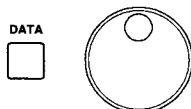
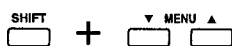

Perform the following steps before starting audio recording.

- 1** Select the ASSEMBLE mode.
- 2** Hold SHIFT and press MENU to access a "5 At-id" menu.

5 At-id -54db

- 3** Press DATA and rotate the dial to select a level at each occurrence of which a Start ID will automatically be registered.

Options available :

- "oFF" : No Start ID is automatically registered.
- "-54 db"
- "-60 db"
- "-66 db"

A Start ID is registered each time a sound louder than the selected level is fed into the deck following a period of silence or of a sound lower than the selected level at least 2 seconds long.

The AUTO ID indicator will light up in the display unless "oFF" is selected.

- 4** Press SET to save your setting.

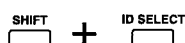

- You can switch the Auto ID function on or off by holding SHIFT and pressing ID SELECT, without having to access the menu.

**Manual Recording
(along with Audio or
during Play)**

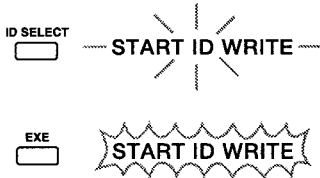

NOTE

You cannot record a Start ID overlapping the existing ID. Previously erase unnecessary marks, as explained later.

- 1** Select the ASSEMBLE mode or the EDIT SUB mode.
- 2** Press ID SELECT until the "START ID WRITE" indicator lights up in the display.
- 3** Start recording if in ASSEMBLE mode, or start playing if in EDIT SUB mode, and hit EXE at the desired moment. The "START ID WRITE" indicator will blink, showing that a Start ID is being recorded. This takes about 9 seconds.

• To fine tune the point where you want a Start ID to start being marked from :

1. During record or play, hit MEMO (1 or 2) at a tentative point.
2. Stop the tape, then follow the same procedure as for "MEMORY START Play" (11-1 through 11-3 on pages 11 • 1 and 2).
3. Enter the EDIT SUB mode.
4. Press ID SELECT until the "START ID WRITE" indicator light up in the display.
5. Press EXE and a Start ID is written from the fine tuned point on.

**To Erase Start IDs
(during Play or Stop)**

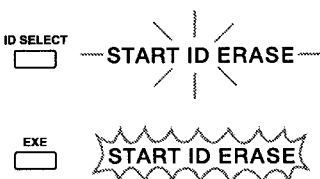

- 1** Select the EDIT SUB mode.
- 2** Press ID SELECT until the "START ID ERASE" indicator lights up in the display.
- 3** When the tape is stopped at or playing a higher point than the Start ID you want to erase, press EXE. The tape rewinds to the beginning of the ID, and this is erased while the tape is playing.

While a Start ID is being erased, the "START ID ERASE" indicator will flash.

NOTE

When erasing a Start ID, the program number is also erased. Renumbering program numbers is explained below.

SECTION 9 : RECORDING SUB-CODE DATA

9-3. Program Numbers

Numbering Programs

Program numbers indicate the position of each program in a sequence. They are automatically registered at the same as Start IDs.

When recording Start IDs (automatically or manually), program numbers are also recorded in sequence to existing numbers. When a Start ID is automatically registered by letting audio record start from the beginning of the tape in ASSEMBLE mode, "001" is assigned to the first program.

- If you want to start audio recording mid-way through a tape, first play the previous program so the deck can read and display its number. Otherwise, no program number is registered.
- Recording the desired program number is explained later, page 10 • 2.
- Program numbers can be recorded from 001 up to 799. But the PGM NO. display shows only the right two digits (the hundreds are not shown).

Erasing Program Numbers

When you erase a Start ID, the program number also is automatically erased.

9-4. Renumbering Program Numbers

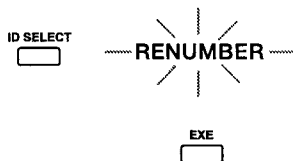

If you erase or add Start IDs, the program numbers on the tape will become out of order. To put them back into order, perform renumbering as follows :

- 1** Enter the EDIT SUB mode.
- 2** Press ID SELECT until the "RENUMBER" indicator lights on the display.
- 3** During play or stop, press EXE.

The tape will rewind, and program number "1" will be recorded at the first Start ID the tape finds. When the first program is numbered (this takes about 9 seconds), the tape will be automatically located to the next Start ID, and this will be numbered "2". This process continues until all the existing Start IDs have program numbers in proper order. When all renumbering is complete the tape will automatically rewind, stopping at the beginning of the tape.

9-5. Recording/Erasing an End ID

An End ID identifies the end of the audio recorded section of a tape. When fast forwarded, the tape will automatically stop at the beginning of the End ID mark, the "END ID" indicator appearing on the display.

If the tape encounters an End ID mark during play, it will rewind, stopping at the beginning of the tape.

NOTE

You can write the End ID mark only during audio recording in ASSEMBLE mode.

Recording an End ID

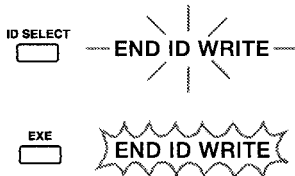

1 Select the ASSEMBLE mode.

2 Press ID SELECT until the display shows "END ID WRITE".

3 Start audio recording, and terminate recording by pressing the EXE key.

The "END ID WRITE" indicator will blink on the display showing an End ID mark is being recorded. After 9 seconds the indicator will go out and the tape will automatically rewind, stopping at the beginning of the End ID mark just written.

Erasing the current End ID

The current End ID mark is automatically erased when a new audio reading is added to the end of the existing audio recordings.

SECTION 10 : AUTOLOCATION FUNCTIONS

You can quickly move to specific points on the tape, points stored in memory. Also, you can tell the DA-60 MKII to find the beginning of specific programs or the ID SEARCH function allows you to skip forward or back to other programs.

10-1. Setting Locations

"On the fly"



You can specify two points on the tape during record or play.

Simply hit MEMO (1 or 2) at the desired moment. The time point shown at that moment on the right hand side of the display is read into the corresponding memory.

Each time either MEMO is pressed, a new memory point is established, erasing the previous memory in that register.

- Hitting MEMO during stop is also effective.

Setting locations at menus



1 Press MENUS until "MEMO 1" (or "MEMO 2") shows in the display. The current memory point will show on the right hand side of the display.



2 Press DATA until the number you want to change starts blinking (H, M, S or F).

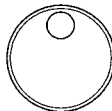

3 Enter the desired number by turning the rotary dial.



4 When all digits are entered and they represent the desired locating point, press SET.

10-2. Autolocating to MEMO points



During stop or play, press LOC 1 to let the tape autolocate to, and stop at, the MEMO 1 point. Or, press LOC 2 to let the tape autolocate to the MEMO 2 point.

- Auto Play Function : Pressing PLAY after LOC will cause the tape to automatically start playing as soon as the location point is reached. MEMORY START must be switched Off.

All MEMO points (whether set at menus or captured on the fly) are automatically saved for later use when switching the power off.

10-3. Locating to a Start ID

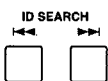

During stop or play, press the forward ID SEARCH key to locate the tape to the next Start ID ; or press the backward ID SEARCH key to locate the tape to the previous Start ID.

Each time you press them, the tape will be located to the next or the last Start ID point. To skip several programs, press the key repeatedly. Each time you press the key, the number in the PGM NO. display window will increment. The "-" or "+" indication before the number shows the direction in which you are locating the tape.

- The DA-60 MKII goes into STANDBY at the end of each search operation.
- During the search process, the REW or the F FWD button will light.
- Auto Play Function : Pressing PLAY after search operation starts will cause the tape to automatically start playing at the end of search operations. MEMORY START must be switched Off.

10-4. Program Number Search



1 Press MENU until the display looks like this :

P-001 1 2 3 ← Current program number
 A B C

(A, B and C shown above are for an explanation.)

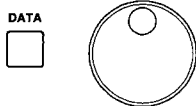

2 Press DATA. The lower two digits (marked B) will start flashing, so change them to the desired numbers (00 to 99) by rotating the dial.

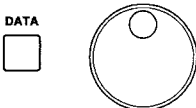

3 Press DATA once more and the highest digit (marked A) will start flashing, so change it to the desired number (0 to 7) by rotating the dial.



4 Press SET to save your setting.



5 Press LOC 1 and the deck will be autolocated to the beginning of the program just specified.

- Auto Play Function : Pressing PLAY after LOC 1 causes the tape to automatically start playing after completing autolocation.
- If MEMORY START is pressed on, 3 seconds of audio will be stored into a memory buffer after completing autolocation. For details see Section 11.

■ **An alternative is to :**

- ① Hold SHIFT and press LOC 1. The "P(rogram)" menu will appear.
- ② Enter the desired program number with the rotary dial, as explained above.
- ③ Press LOC 1 (directly, without pressing SET) and the deck will start autolocation.



■ **Another Use of the "P" Menu — Assigning the desired program number when registering a Start ID**

After completing step 4 above, hold SHIFT and press SET. The program number entered will show at the right (marked C) and also in the PGM NO. display window. Then, the deck recognizes this number as the current program number and, upon registering a Start ID, the next number is registered (e.g. 100 if 99 is entered).



SECTION 11. MEMORY START OPERATIONS

MEMORY START stores digital audio into a memory buffer over the length of about 3 seconds from a cue point on. This ensures an instantaneous, tight start because audio is read from the buffer not directly from the tape when you hit PLAY.

If you want to store audio from an AUTO CUE point on, first select a trigger level of the auto cue circuit, as explained under the corresponding heading, page 11 • 2.

11-1. To Store Audio into a Memory Buffer

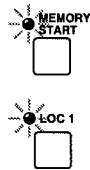

- 1** Press MEMORY START. Its LED will turn on.
- 2** Have the deck autolocate to the desired memory point by pressing LOC 1 or 2. Or, use the ID SEARCH function to access the beginning of the desired program.
- 3** After completing autolocation, the deck enters play mode, storing audio data into a memory buffer, as confirmed by the MEMORY START LED flashing. About 3 seconds later, the LED glows solid and the tape rewinds, parking at the cue point in Memory Start Standby mode, as confirmed by the STOP button being lit and the PLAY button flashing.

11-2. To Audition the "Buffered" Audio

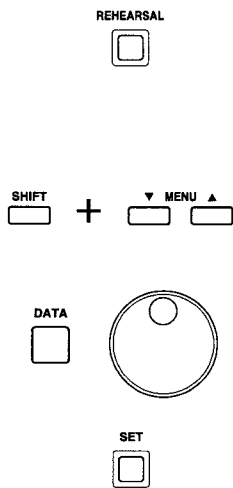

Pressing REHEARSAL while in Memory Start Standby mode allows you to hear audio for a user selected time (see below) as it is read from memory, not directly from the tape.

To Set the "Rehearsal" Time of Memory Start :

- 1** Hold SHIFT and press MENU to access a rehearsal time menu which looks like this :
7 rEH-t 2000 ms
- 2** Press DATA and rotate the dial to display the desired time (from 100 to 2500 ms, in 100 ms steps).
- 3** Press SET to save the setting.

11-3. To Trim Your Memory Start Point



- 1** Press DATA while in Memory Start Standby mode. The tape will play a loop of about 200 msec over and over. This loop precedes the beginning of the buffered 3 seconds of audio. You'll notice that "00" is flashing in the PGM NO. display window.
- 2** Rotate the dial to the left or right. The playing loop will move back or forward in 1 frame steps, up to 30 frames ahead of or behind the original point, as confirmed by the PGM NO. display.



3 Once the memory start point is trimmed to your satisfaction, press SET. Repeat play stops, the new memory start point is saved and the previous memory is erased.

- If you press RESET instead of SET, repeat play stops and the original memory start point is retained.
- If you press a MEMO after SET, the memory start point just trimmed is stored into the corresponding register.
- The frame numbers you see in the PGM NO. display window are those of ABS time. But upon pressing SET, the ABS time data is converted to a timecode selected at the menu "22 rEFtc" (page 7 • 2).

NOTE

You cannot trim a memory start point when a "7 rEH-t" menu is shown.

11-4. Auto Cue Trigger Level

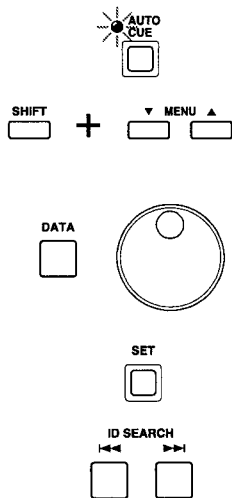

If AUTO CUE is on, the deck starts storing 3 seconds of audio upon encountering a sound louder than a user selected level after passing by a point 1 second lower than a Start ID.

You can set the sensitive level of the Auto Cue circuit to -54, -60 or -66 dB, depending on the type of material you're working on.

1 Press AUTO CUE and its LED will light.

2 Hold SHIFT and press MENU to access an Auto Cue menu which looks like this :

6 AtcuE -54 db

3 Press DATA to let the number display at the right start blinking, then turn the dial to enter the desired level number.

4 Press SET to save your selection.

5 Press MEMORY START to have its LED light, and let the deck autolocate to a Start ID using the ID SEARCH function. When a sound louder than the selected level is encountered after passing by a point 1 second lower than the Start ID, 3 seconds of audio are stored into a memory buffer and the deck parks in Memory Start Standby mode.

- If no sound louder than the selected level is encountered within 5 seconds after passing by a point 1 second lower than a Start ID, the deck will rewind the tape to the beginning of the Start ID, storing 3 seconds of audio from that point on.

11-5. Executing a Memory Start Play



Press PLAY while in Memory Start Standby mode.

SECTION 12 : PUNCH IN AND OUT

The DA-60 MKII's editing possibilities include click-free dropping into and out of record with an inbuilt crossfade action. The crossfade time is selectable at a menu.

12-1. To Select a Crossfade Time

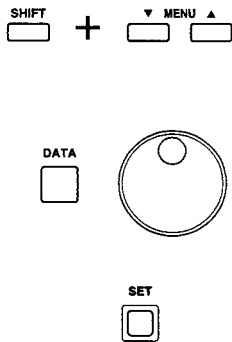

1 Hold SHIFT and press MENU to access a Fade menu which looks like this :

9 FADe 10

2 Press DATA and rotate the dial to change the flashing current crossfade time (unit : ms) to 10, 50 or 100.

3 Press SET to save the setting.

12-2. Automatic Insertion

Setting Punch In and Out Points



1 Load the point where you want the deck to drop into record into the MEMO 1 register, as explained in Section 10.

2 In a similar way, load the point where you want the deck to drop out of record into the MEMO 2 register.

- You can trim the punch in and out points using the same procedure as for the memory start point (pages 11 • 1 and 2).

NOTE

There must be at least 5 frames between the punch in and out points.



3 Enter the EDIT AUDIO mode.

4 Press AUTO IN/OUT. Its LED will light.

Setting a Preroll Time

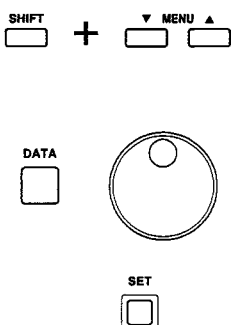

5 Hold SHIFT and press MENU to access a preroll time menu which looks like this :

13 PrE-r 5

6 Press DATA, and the number display at the right starts flashing, and rotate the dial to enter the desired time (0 to 15 seconds).

7 Press SET to save the setting.

- When controlling the DA-60 MKII from P-2, the deck configures itself for an incoming preroll time.

Rehearsal



8 Press REHEARSAL, and the tape will fast wind, stopping the preroll time short of the punch-in point, and the AUTO IN/OUT LED will start flashing.

9 Press PLAY to have the tape start playing, the AUTO IN/OUT LED glowing solid.

- The monitor will automatically switch to SOURCE when the punch-in point is reached.
- The monitor will switch back to TAPE when the punch-out point is reached.

After about 3 seconds of postroll, the tape will rewind, and stop at the preroll start point, and the AUTO IN/OUT LED will start flashing again.

You can rehearse your punch-in as many times as you need without destroying the original take at all.

Committing the insertion to tape



10 Press RECORD and then press PLAY. The same sequence as you have anticipated during Rehearsal will take place.

12-3. Manual Punch In and Out

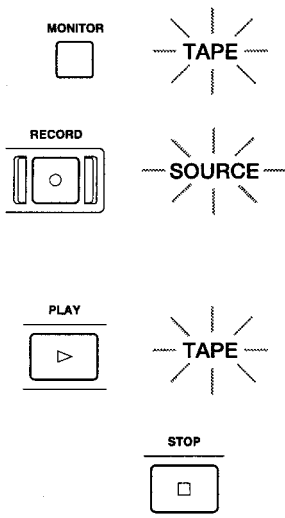

1 Enter the EDIT AUDIO mode.

2 Press MONITOR until "TAPE" shows on the display.

3 Start playback from a point lower than the expected punch-in point and, the instant this point is reached, hit RECORD. The monitor will switch from TAPE to SOURCE at the same time as initiating record.

- The MONITOR switch cannot operate while in record mode.

4 Hit PLAY when the point where you want to punch out of record is reached. The monitor will switch back to TAPE, allowing you to check if the new recording is smoothly followed by the previously recorded section.

5 Press STOP to stop the postroll.

SECTION 13 : FADE IN AND OUT

You can have the DA-60 MKII fade in and out of play or record ("A"-weighted).

NOTE

It is necessary to have the MEMORY START LED light up for playback to fade in and out.

13-1. Setting the Fade In/Out Time

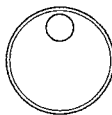
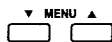

- 1** Using the MENU keys have the "FADE IN" and the "FADE OUT" indicators light up on the display, and the current setting will show on the right hand side of the display, like this :

in 3 out 5

- 2** Press DATA, and the fade in time display will flash, and rotate the dial to enter the desired time (0 to 9 seconds).

Pressing RESET zeroizes the time display.

- 3** Press DATA once again, and the fade out time display will flash, and enter the desired time using the dial.

- 4** Press SET to save the setting.

13-2. The Fade In Function

Before starting playback or recording, check to see that both the FADE IN and the FADE OUT indicators are lit on the display.

■ Fading in play

When starting playback, the sound will fade in over the preset time.

■ Fading in record

When starting record in ASSEMBLE mode, the input will fade in over the preset time.

13-3. The Fade Out Function

Both the FADE IN and the FADE OUT indicators must be lit on the display.

■ **Fading out of play**

Upon pressing STOP during play, the sound starts fading away and, at the end of the preset fade out time, the tape stops.

■ **Fading out of record**

Upon pressing STOP during record in ASSEMBLE mode, the input starts fading away and, at the end of the preset fade out time, the tape stops.

Monitoring the Fade In/Out Action

In PLAY you can monitor how the sound fades in and out at the digital and the analog outputs.

In RECORD also you can monitor the fade in/out action if the monitor is switched to TAPE.

SECTION 14 : PLAY AT VARIABLE SPEEDS

You can vary the play speed within the limits of +/-12.5 %, in 0.1 % steps.

- The play speed is variable only when the CLOCK switch is set to INT.

14-1. To Change the Pitch

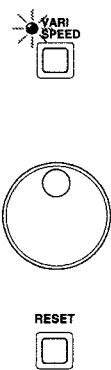

- 1** During stop or play, press VARI SPEED to access a pitch menu.

The VARI SPEED LED will light up, and the "PITCH" indicator and the current pitch will show on the display.

- 2** Turn the dial to enter the desired amount of pitch. If the tape is playing, the pitch will change as you rotate the dial.

- To return to standard pitch, clear the pitch display to 00.0% with the dial or by pressing RESET.

14-2. Cancelling the Variable Speed Mode



Press the VARI SPEED key once again, and its LED will go out, and also the PITCH indicator.

- Cancelling the variable pitch mode does NOT erase the pitch changes from memory.

14-3. Checking the Current Pitch



Once after having quitted the variable speed mode, if you want to check to see the current pitch, press MENU until the PITCH indicator lights up on the display.

- You can change the pitch regardless of whether the VARI SPEED or the MENU keys are used to access the pitch menu.

SECTION 15 : SLAVING TO EXTERNAL MACHINES

15-1. Hookup Examples

Slaving to a VTR

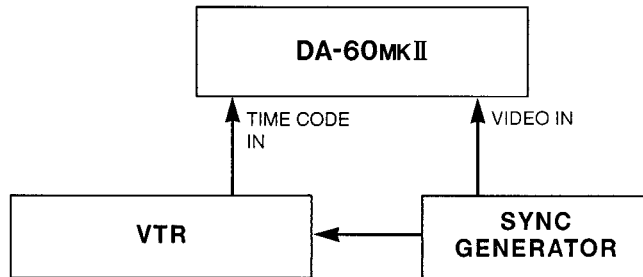

Slaving to a DAT

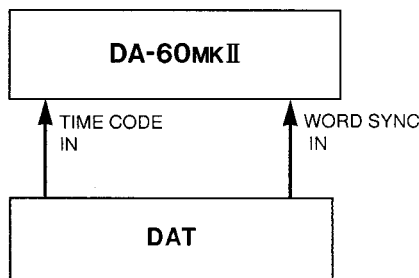

Slaving to an ATR

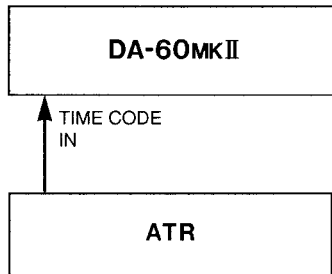

15-2. Setting-up the DA-60 MKII

Selecting a Reference Clock

Depending on your system hookup, set the CLOCK switch to :

- INT if the master is an ATR,
- EXT if the master is a DTR or
- VIDEO if the master is a VTR.

If EXT is selected, set the EXT SYNC switch to :

- WORD for referencing to the clock derived from the word sync in OR
- DIGITAL for referencing to the clock derived from the digital in (AES/EBU).

Normally, use the word clock. Only when it is not available, use the clock from the digital in.

SECTION 15 : SLAVING TO EXTERNAL MACHINES

Selecting a Playback Timecode Source

Refer to Section 8.

Selecting a Timecode Type

Refer to Section 7.

Checking the Timecode from the Master Machine



If you want to see the timecode numbers coming into the TIME CODE IN from the master machine, have the EXT TC indicator light up on the display by means of the MENU keys. You'll see the timecode numbers from the master on the right hand side of the display.

Checking the Timecode Type on the Tape in the DA-60 MKII

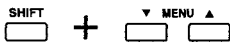

Hold SHIFT and press MENU's to access the menu "20 tPtc".

20 tPtc 30 ndF

To the right of the menu name shows one of the following indications :

- 30 ndF (30 f/s, non drop)
- 2997 ndF (29.97 f/s, non drop)
- 2997 dF (29.97 f/s, drop)
- 25 Ebu (25 f/s)
- 24 FiL (24 f/s)
- 30 dF (30 f/s, drop)

A broken line will show instead if no timecode is present on the tape.

Selecting a Chase Mode

The DA-60 MKII offers two chase modes :

- (1) Re-chase mode (default) — The DA-60 MKII duplicates every action of the master.
- (2) Free mode — As soon as sync is achieved, the DA-60 MKII starts playing independently of the master.

To select the free mode :

1 Hold down SHIFT and repeatedly press MENU until the display shows :

23 cCHASE rE-cCHASE

2 Press DATA, and turn the rotary dial to change the blinking "rE-cCHASE" to "FrEE".

3 Press SET to save the selection.

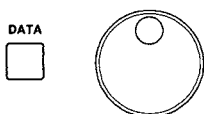
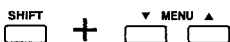

Timing the Timecode Output

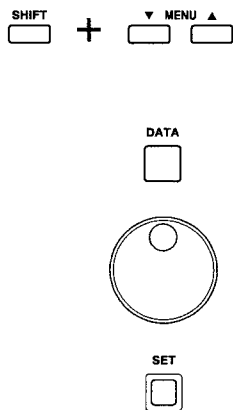

The DA-60 MKII defaults to Analog mode so that the timecode output is timed to coincide with the analog output. If you intend to use the digital output, follow these steps, and the timecode output will be timed to coincide with the digital output.

1 Hold down SHIFT and repeatedly press MENU to access a timecode delay menu, which looks like this :

25 tcdLy AnA

2 Press DATA, and the "AnA" will start blinking.

3 Turn the rotary dial to change the "AnA" to "diG."

4 Press SET.

Selecting a Play Start Point

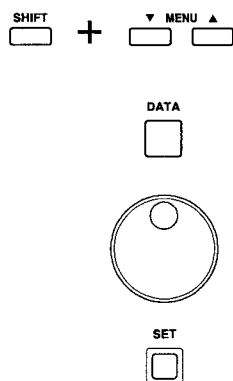

When the DA-60 MKII chases the master and comes a certain distance short of it, the former starts playing at intermediate speeds, and as soon as sync is achieved, goes into normal play mode. If you want the DA-60 MKII to start playing only after locking to the master, follow these steps :

1 Hold down SHIFT and press MENU until the display reads :

27 cHS-A PLAY

2 Press DATA. The "PLAY" will start blinking.

3 Turn the rotary dial to change the "PLAY" to "Loc".

4 Press SET.

15-3. Synchronization

We'll use the DA-60 MKII as a slave.

- If the inbuilt timecode generator is in Free run mode, no timecode is read from the tape. If in doubt, check the current setting at the menu "24 tcGen" (pages 7 • 2 and 3).

1 Put the master machine into play mode.

2 Press CHASE on the DA-60 MKII.

- The CHASE LED is always lit regardless of whether it is chasing or syncing if the deck is in Re-chase mode. If the deck is in Free mode, the LED turns off as soon as the deck locks to the master.

- A SERVO LOCK indicator will light at the left of the display as soon as the deck locks to the master. But speaking of remembering this indicator lights also to simply show that the tape is correctly running.

- To disable the chase mode, press STOP.



SECTION 15 : SLAVING TO EXTERNAL MACHINES

Relative Difference Time Display

When you have the EXT TC indicator light with the MENU keys and timecode numbers from the master machine are showing on the right hand side of the display, press SHIFT, and a relative difference time is displayed to sub-frame accuracy (1/100 frame).

- The relative difference time is a time obtained by subtracting offset values from the absolute difference between the master and the slave timecode numbers.
- Pressing any other keys than SHIFT reverts the display to show the master timecode numbers.

15-4. Syncing with an Offset

Entering an Offset Value

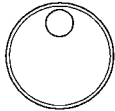
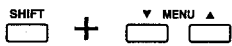

Offset can be programed at any time, even while syncing, up to +12:00:00:00.00, or down to -12:00:00:00.00, in 1 sub-frame (1/100 frame) steps.

1 Press MENU until "■ CHASE OFFSET" lights up on the display and below the indicator will show the current offset value.

2 Press DATA. The hour digits will start blinking.

Each time you press DATA, the next lower (right) two digits will blink.

3 When the digits you want to set are blinking, turn the rotary dial so as to display the desired number.

You can press RESET to clear the blinking digits to 00.

4 When you are satisfied with all the hour, minute, second, frame, and subframe displays, press SET.

- If you enter or change the offset while the machines are syncing, you can hear the DA-60 MKII's sync point move relative to the master.

15-5. Auto Offset Entry

You can capture the current difference between the master and the slave timecode numbers "on the fly" so the DA-60 MKII gets synced up to a master with a lag corresponding to the offset value thus entered.

1 Let the master play, and also the DA-60 MKII (slave).

2 Press MENU until "■ CHASE OFFSET" lights up on the display and below the indicator will show the current offset value.

3 When the slave tape approaches the expected sync point, hold down SET and, when the point is reached, hit CHASE.

The time display now shows the captured offset time, the DA-60 MKII starting to chase the master.

- To disable the offset sync operation, press STOP.

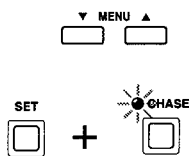

15-6. Punch In and Out while Syncing

You can have the DA-60 MKII drop into and out of record while it is playing in sync with a master, manually or automatically.

NOTE

There must be at least 5 frames between the punch-in and out points.

Manual Insertion

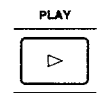
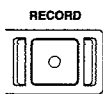

Auto Insertion



- 1** Enter the EDIT AUDIO mode.
- 2** Have the DA-60 MKII play in sync with a master.
- 3** At the point where you want the DA-60 MKII to drop into record, hit RECORD.
- 4** Hit PLAY and the deck punches out of record.

- 1** Enter the EDIT AUDIO mode.
- 2** Press AUTO IN/OUT, and its LED will light.
- 3** Load a punch-in point into the MEMO 1 register, and a punch-out point into the MEMO 2 register.
- 4** Press CHASE.
- 5** After once sync is achieved, control the master transport to locate the DA-60 MKII to a point more than 5 seconds lower than the programed punch-in point.

When the DA-60 MKII plays up to the point 5 seconds lower the programed punch-in point, the AUTO IN/OUT LED will start blinking.
- 6** If a trial punch in (rehearsal) is required, press PLAY on the master.
- 7** When the trial punch in is over, press STOP on the master, and locate the DA-60 MKII to a point more than 5 seconds lower than the programed punch-in point by controlling the master transport.

15-7. Slaving to a Video Picture

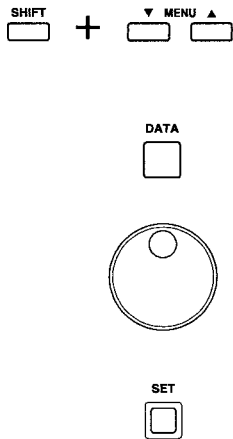

The DA-60 MKII is or is not capable of getting synced up to rising edges of the video frame, as selected at a "26 SYnc P" menu.

- The CLOCK select switch must be set to VIDEO and the Free mode must be selected at the menu "23 CHASE" (page 15 • 2).

To check or change the current selection at the menu "26 SYnc P" :

- 1** Hold down SHIFT and press MENU until the display shows :

26 SYnc P on

- 2** Press DATA. The "on" will start blinking.

- 3** Turn the rotary dial to change the "on" to "oFF" or vice versa.

- 4** Press SET.

SECTION 16 : OPERATIONS CONFORMING TO P2 PROTOCOL

16-1. Initial Settings

To Get Ready to Access P2-related Menus

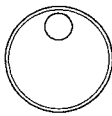
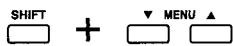

Setting at a "9P-id" Menu

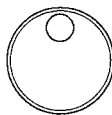
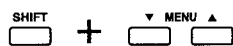

To control over a P2 interface the DA-60 MKII from editors/controllers which you'll connect to the RS-422 connector on the DA-60 MKII :

Make the following switch settings.

- REMOTE to ON
- CLOCK to VIDEO or WORD

If you set CLOCK to VIDEO, select "on" at the menu "26 SyncP".

In addition, follow these steps :

- 1** Hold SHIFT and press MENU until the display reads :

P2 cLoSE

- 2** Press DATA and the "cLoSE" will start flashing.

- 3** Turn the rotary dial to change the "cLoSE" to "oPEn".

- 4** Press SET so you are ready to access P2-related menus.

Follow these steps to select an ID with which the DA-60 MKII responds upon receiving a Device Type Request command from editors/controllers.

- 1** Hold SHIFT and press MENU until the display reads :

9P-id -0-7050

- 2** Press DATA and, as you turn the rotary dial, the following options will show in sequence :

- 0 - 7050	:PCM-7050
- 1 - 3000	:BVH-3000
- 2 - 950	:BVU-950
- 3 - 75	:BVW-75
- 4 - 9850	:VO-9850
- 5 - 2000	:BVH-2000
- 6 - 10	:DVR-10
- 7 - tEAC	:TEAC

Editors/controllers use different procedures to control different machines. We recommend that you select the "PCM- 7050" setting. If your editor/controller does not identify the DA-60 MKII, try other settings.

- 3** Press SET to save the setting.

SECTION 16 : OPERATIONS CONFORMING TO P2 PROTOCOL

Setting at a "SPEEd" Menu

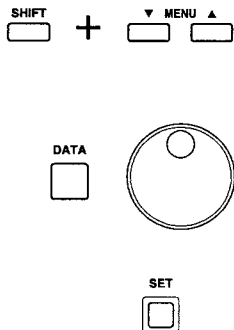

When the DA-60 MKII receives a REW or F FWD command from editors/controllers, the tape runs at 9 times the normal play speed or at 150 times, as selected at the menu "SPEEd". The default setting is 150. To change it to 9 :

1 Hold SHIFT and press MENU until the display reads :

SPEEd FAST 150

2 Press DATA and turn the rotary dial to change the "150" to "9".

3 Press SET to save the setting.

- Depending on editors/controllers, they either only tell recorders to find specific points on tape (after receiving a locate command, recorders act independently to find the specified point themselves) or they continue to control recorders by issuing commands such as REW, F FWD, Shuttle, etc.

In the latter case, fast winding the tape at 150 times the normal speed would result in a considerable overshoot ; autolocation may not complete at the expected point. To overcome this problem, select a 9 times speed at the menu "SPEEd".

Setting at a "422AdrS" Menu

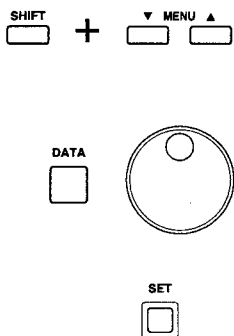

When controlling this unit from the TASCAM ES-61 edit controller by connecting to its ADDRESSABLE terminal, you have to select an address number as follows :

1 Hold SHIFT and press MENU until the display reads :

422AdrS 1

2 Press DATA, and turn the rotary dial to have the required number (1-16) be shown.

3 Press SET to save the setting.

16-2. Memory Jog

This feature is used to fine tune marks to which you want to autolocate by pressing "GO TO" or an equivalent key on your editor/controller.

The fine tuning operation consists in playing seconds of audio preceding and following a marked point, to store them into a memory buffer for MEMORY START, and finding the exact edit point while auditioning the sound from the memory buffer.

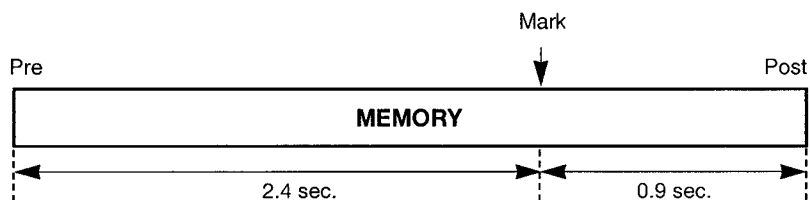

Setting on the DA-60 MKII

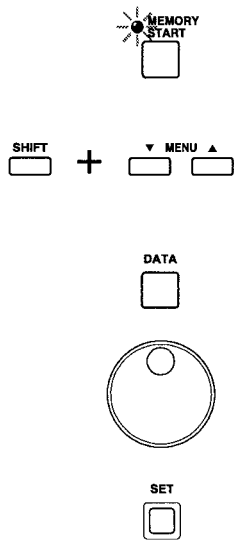

1 Enter MEMORY START mode by pressing the corresponding key.

2 Hold SHIFT and press MENU until the display reads :

JOG-Ed oFF

3 Press DATA and the "oFF" starts flashing.

4 Turn the rotary dial to change the "oFF" to "on".

5 Press SET to save the setting.

On the Editor/Controller

1 Mark an In or Out point.

2 Press GO TO, and the tape is located to the mark and audio is stored into memory. When storage is complete, the MEMORY START LED stops flashing, glowing solid.

3 Enter a Jog mode, and turn the Jog dial to hear the 'buffered' audio . As you rotate the dial to the left or right, the edit point will move back and forwards as confirmed by the timecode number display.

Each time you stop the dial, you will hear 150 msec. or 5 frames (30 msec.= 1 DAT frame) of audio before the trimmed point.

4 Enter a Shuttle mode. While the shuttle mode is 'stilled', turning the jog dial to the right offers a trial play, allowing you to hear 1 second of audio from the trimmed point on at the standard speed. The trial play will stop upon entering the shuttle still mode again.

- Turning the dial to the left has no effect at all.

5 When trimming the edit point to your satisfaction, replace the original point with the trimmed one.

- Audio before and after a marked point is saved also when activating PREVIEW on editors/controllers.
- The memory buffer in the DA-60 MKII is used for the Memory Jog function when the REMOTE switch is pressed on ; or for the Memory Start function if the switch is off.

SECTION 17 : LISTS OF MENUS

Menus are divided into two groups. Menus that you can access by pressing only MENU are grouped under "Group 1", and all other menus that you can access by holding SHIFT and pressing MENU are grouped under "Group 2".

Settings and changes at menus become the default (they are not lost when turning off power). See also SNAPSHOTS OF YOUR SETTINGS AT MENUS later in this section.

GROUP 1

Indication	Used for	See also p.
MEMO 1	Setting a point to which you want to autolocate or showing content of the corresponding register.	10 • 1
MEMO 2	(“)	(“)
FADE IN & FADE OUT	Setting/displaying the length of fade in and out. The fade in and out actions occur only when this menu is shown.	13 • 1 & 2
PITCH	Setting the pitch change or displaying the current setting.	14 • 1
(no indication)	Specifying a program for the deck to find it.	10 • 2
EXT TC	Displaying the timecode numbers coming into the TIME CODE IN.	15 • 2, 15 • 4
GEN TC	Displaying the timecode numbers as the inbuilt generator produces.	7 • 3
GEN TC SET	Setting the start time of the inbuilt generator.	7 • 3
CHASE OFFSET	Entering an offset or displaying the current offset value.	15 • 4
U-BIT EXT	Displaying U-BIT data coming from the exterior.	—
U-BIT	Displaying U-BIT data read from the tape loaded on the DA-60 MKII (if available).	—

GROUP 2

Menus of Group 2 can be accessed in either of two ways :

Press MENU while holding SHIFT, or

Rotate the DATA dial while holding SHIFT.

To switch the menu display (at the left) back to show timecode numbers, press either MENU key.

Menu	Option	Factory preset	Description	See also p.
1 Audio	cH-1, cH-2	cH-1	Selects a source for the MARGIN display.	17 • 3
2 Hour	XXXX (H)	—	Shows the head drum operating time.	17 • 3
3 PrEEP	oFF, on	oFF	Toggles Emphasis On/Off for the analog inputs.	5 • 4
4 coPY	00, 10, 11	00	Specifies a copy flag to be recorded.	5 • 2
5 At-id	-54,-60, -66 dB, oFF	-54	Specifies a level at the occurrence of which Start IDs are automatically marked during ASSEMBLE mode.	9 • 1
6 AtcuE	-54,-60,-66 dB	-54	Selects a trigger level of the auto cue circuit.	11 • 2
7 rEH-t	100 to 2500	2000	Sets the MEMORY START "rehearsal" time (in ms).	11 • 1
8 tALLY	StAndArd, rc-d6	StAndArd	Configures tally signals available at the parallel port for the optional RC-D6 remote or for other units.	17 • 3
9 FAdE	10, 50, 100	10	Specifies a time during which crossfade will occur at punch in and out points.	12 • 1
10 P-HLd	Auto, HoLd, oFF	Auto	Determines the level meter functions.	17 • 3
11 rLS-t	10, 50	10	Specifies a release time of the level meters.	—

(Cont.)

SECTION 17 : LISTS OF MENUS

Menu	Option	Factory preset	Description	See also p.
12 iSdFt	oFF, iS on, iScuE	oFF	Determines whether only MEMORY START or a combination of MEMORY START and AUTO CUE is automatically activated each time the deck is turned on.	17 • 3
13 PrE-r	0 to 15	5	Selects a preroll time for insertion.	12 • 1
14 bAnd	nrr on, nrr oFF	nrr on	Sets the limit of variation in the frequency of external sync signals.	17 • 4
15 AtinP	oFF, on	oFF	Inputs to the DA-60 MKII can or cannot be monitored while in rewind, fast forward or stop, as selected at this menu.	17 • 4
-cALL-	FAct, rEG1, rEG2, rEG3	FAct	Reads menu settings from the corresponding registers.	17 • 5
-StorE-	rEG1, rEG2, rEG3	rEG1	Stores menu settings into one of the three registers.	17 • 5
-tc-	cLOSE, oPEn	cLoSE	Selecting "oPEn" allows you to access the following timecode-related menus.	7 • 1
20 tPtc	30ndF, 2997ndF, 2997dF, 25Ebu, 24FiL, 30dF	—	Shows the type of timecode available on the tape loaded on the DA-60 MKII.	15 • 2
21 Pbtc	Auto, tc, AbS	Auto	Depending on the setting at this menu, professional DAT timecode or ABS time data available on the tape is converted to SMPTE/EBU timecode numbers.	8 • 1
22 rEFtc	30ndF, 2997ndF, 2997dF, 25Ebu, 24FiL, 30dF	2997dF	Used to select a type of timecode to which the whole system is referenced.	7 • 2
23 cHASE	FrEE, rE-cHASE	rE-cHASE	The chase and lock action occurs only once or repeats, as selected at this menu.	15 • 2
24 tcGEn	oFF, rEc run, FrEE run, J-Sync	rEc run	The inbuilt generator operates depending on modes selected at this menu.	7 • 2
25 tcdLy	AnA, diG	AnA	Determines whether the timecode output is timed to coincide with the analog input or with the digital input.	15 • 3
26 SyncP	oFF, on	on	Video sync play is switched on or off from this menu.	15 • 6
27 cHS-A	PLAy, Loc	PLAy	The DA-60 MKII starts playing only when sync is achieved or when approaching a sync point, as selected at this menu.	15 • 3
--P2--	cLoSE, oPEn	cLoSE	Selecting "oPEn" allows you to access the following P2-related menus.	16 • 1
9P - id	-0- 7050, -1- 3000, -2- 950, -3- 75, -4- 9850, -5- 2000, -6- 10, -7- tEAC	-0- 7050	Selects an ID with which the DA-60 MKII responds upon the device type request from editors/controllers.	16 • 1
SPEEd	FASt 150, FASt 9	FASt 150	Determines whether the DA-60 MKII starts running at 150 times normal speed or at 9 times speed upon receipt of a rewind or fast-forward command from editors/controllers.	16 • 2
JoG - Ed	oFF, on	oFF	Upon receipt of locate commands such as "Cue up with data" from the editors/controller used, seconds of digital audio preceding and following a specific location can or cannot (depending on the setting as this menu) be stored into memory buffer inside the DA-60 MKII, to trim the location ("Memory Jog").	16 • 3
422AdrS	1 to 16	1	Used to select an address number when connecting to ADDRESSABLE terminal on the TASCAM ES-61 edit controller.	16 • 2

SECTION 17 : LISTS OF MENUS

More Information about Some Menus of Group 2

• 1 Audio

When this menu is shown, the MARGIN display indicates how much level is available in the selected channel before clipping.

- This menu may be helpful for system calibration.
- When the MARGIN display reads -16 dB (reference value), the indicator ● lights. Smaller margins cause the ► indicator to light ; and larger margins cause the ◀ indicator to light.

• 2 Hour

When this indication shows on the right hand side of the display, the numbers you will see at the left show how many hours the head drum has spun since the initial utilization of the DA-60 MKII. This will be useful in carrying out your periodic maintenance plan on time.

• 8 tALLy :

At this menu you can select the destination of tally signals available at the ACCESSORY 1 port.

- Be sure to select "rc-d6" when connecting an optional remote (RC-D6) to the ACCESSORY 1 port.

• 10 P-HLd :

At this menu you can determine whether readings on the level meter will be held for a default time or as long as you want.

- When selecting "Auto", each peak reading will be held for about 1 second.
- When selecting "HoLd", readings will continue to be held until you select "Auto" or "oFF".
- When selecting "oFF", readings are not held.

• 12 iSdFt :

- When selecting "iS on", MEMORY START will automatically be activated upon powering up, as confirmed by the associated LED being lit.
- When selecting "iScuE", MEMORY START and AUTO CUE will both automatically be activated, as confirmed by both LEDs being lit.
- When you don't need those functions, select "oFF".

• 14 bAnd

CLOCK MODE	nrr on	nrr oFF
EXT	Recording is possible when the frequency stability of the clock derived from the WORD or DIGITAL IN is within +/- 100 PPM.	Recording is possible when the clock frequency stability from the WORD or DIGITAL IN is within +/- 12.5%
VIDEO	DA-60 MKII is referenced to the clock derived from the VIDEO IN. The VIDEO indicator will flash and the internal clock mode will be entered if the selected TC format does not match with the incoming video signal frequency.	Differences between the selected TC format and the incoming video signal frequency don't disable the video clock mode.

When selecting "nrr oFF", the DA-60 MKII can record at the pitch variation of +/-0.1 % despite the inconsistency between the timecode rate and the video input frequency (as shown in tables below). When referencing to the internal clock, the deck allows recording at variable speeds within the limits +/-0.2 %.

Setting for Pull Up (Recording at +0.1% speed for Film production)

	Without 30 Hz Video Sig.	With 30 Hz Video Sig.
CLOCK SW	INT	VIDEO
14 bAND	----	nrr oFF
22 rEFtc	29.97 ndF / 29.97 dF	29.97 ndF / 29.97 dF
VIDEO IN Sig.	----	30 Hz
Pitch Change	+0.1% (VARI SPEED)	----

Setting for Pull Down (Recording at -0.1% speed for HD TV)

CLOCK SW	VIDEO
14 bAND	nrr oFF
22 rEFtc	30 ndF / 30 dF
VIDEO IN Sig.	29.97 Hz

• 15 AtinP

When selecting "on" at this Auto inPut menu, the monitor automatically switches to the input ("SOURCE") whenever you press REW, F FWD, STOP, LOC or ID SEARCH while in ASSEMBLE mode.

- Once after the monitor is switched to the input, the MONITOR switch can be used to toggle between input/tape options. The broken line (---) in the table indicates that the monitor can be switched only with the MONITOR switch.

REC FUNCTION			During RECORD	During PLAY	STOP REW F FWD
ASSEMBLE	15 AtinP	oFF	---	Tape	---
		on	Tape	Tape	Source
EDIT AUDIO			Source	Tape	Tape

SECTION 17 : LISTS OF MENUS

"SNAPSHOTS" OF YOUR SETTINGS AT MENUS

You can take three snapshots of all your settings at menus (of Groups 1 and 2), and switch the DA-60 MKII from snapshot to snapshot.

As you make settings at menus, the DA-60 MKII stores your settings into register 0. To take a snapshot of the contents of this register and save to another register for later recall :

1. Hold SHIFT and press MENU until "-storE-" shows on the left hand side of the display. At the right you'll see a register indicator be flashing.
2. Press DATA, and select one of the three registers with the rotary dial. Upon pressing SET the contents of register 0 are stored into the selected register.

- Contents of register 0 are not lost when switching power off, but they are replaced when recalling a snapshot from other registers as follows :

To recall a snapshot

1. Hold SHIFT and press MENU until "-cALL-" shows on the left hand side of the display.
2. Press DATA and turn the rotary dial to have the desired register number appear at the right. Upon pressing SET the contents of the selected register are read into register 0.

- If you select "FActory", all the menus will be switched back to their factory presets.

SECTION 18 : ERROR MESSAGES EXPLAINED

18-1. Coded Error Messages

When an error condition exists inside the DA-60 MKII, this generates such messages as shown here.

Servo-related Error		
Error Code	Problem	Remedy
1-1	Incorrect data transmission to/from the Control Circuit Board	A
1-2	No rotation of drum motor	A
1-3	Cassette not loaded correctly	A
1-4	No rotation of takeup reel motor	A
1-5	No rotation of supply reel motor	A
1-6	Condensation on the head drum	B

Digital-related Error		
Error Code	Problem	Remedy
2-1	Incorrect data transmission to/from the Control Circuit Board	A
2-2	Incorrect function of system clock circuits	A

Control-related Error		
Error Code	Problem	Remedy
3-1	Backed-up data destructed	C

RAM-related Error		
Error Code	Problem	Remedy
4-1	Incorrect data transmission to/from the Control Circuit Board	A

Sync-related Error		
Error Code	Problem	Remedy
5-1	Incorrect data transmission to/from the Control Circuit Board	A

Remedy :

- A. Switch the power off, then switch it on again.
- B. Leave the unit turned on for 1 hour or 2 until the error message goes out.
- C. There is no detriment effect on the general functions of the unit, but no data about your settings can be retained in a backup memory when the unit is turned off unless lithium batteries are replaced.

If you use remedy A or B and error messages don't turn off, or if the lithium batteries need to be replaced, please contact TASCAM at the address shown on the back of the DA-60 MKII's manual or your nearest TASCAM dealer.

SECTION 18 : ERROR MESSAGES EXPLAINED

18-2. Flashing Messages

Wrong settings and connections would cause the following messages to appear.

Indication Flashing	Problem and Remedy
WORD	<ul style="list-style-type: none"> ● WORD EXT SYNC is selected, but the necessary clock is not coming in, and the unit is referenced to the internal clock instead. <p>Check to see if a word sync signal is plugged into the word sync in. If it is OK, check if any different sampling rate data than the incoming one is already recorded on the tape (see also "Fs" below).</p>
DIGITAL	<ul style="list-style-type: none"> ● DIGITAL EXT SYNC is selected, but the DA-60 MKII is referenced to the internal clock. <p>Check to see if a digital audio is plugged into the digital in. If it is OK, check if any different sampling rate data than the incoming one is already recorded on the tape (see also "Fs" below).</p> <ul style="list-style-type: none"> ● The clock selected on the DA-60 MKII is not the same as the incoming clock. <p>Select the correct clock or change the clock setting on the external machine to match the clock selected on the DA-60 MKII</p>
VIDEO	<ul style="list-style-type: none"> ● VIDEO CLOCK is selected, but the DA-60 MKII is referenced to the internal clock. <p>Check to see if video signal is plugged into the video in, or if the frame rate (of time code) selected on the DA-60 MKII matches the incoming frame rate.</p>
EXT TC	<ul style="list-style-type: none"> ● EXT TC is selected to record on the DA-60 MKII, but no time code is coming in. <p>Check to see if time code is plugged into the time code in. This indicator flashes also when the DA-60 MKII is in Chase mode but no timecode is coming from a master transport (because this is stopped or for any other reasons).</p>
Fs 48.0 k	<ul style="list-style-type: none"> ● The tape inserted to the DA-60 MKII carries some material already recorded at 44.1 kHz and you attempted to record additional material to augment the original one, but the Fs switch is set to 48.0 kHz or the incoming rate is 48.0 kHz. <p>If the Fs switch is set to 48.0 kHz, set it to 44.1 kHz. If the incoming rate is not 44.1 kHz, don't use that source. It is not recorded correctly no matter how the Fs switch is set.</p>
Fs 44.1 k	<ul style="list-style-type: none"> ● Similar to the above case, but the old material was recorded at 48.0 kHz, and the Fs switch is set to 44.1 kHz or the incoming rate is 44.1 kHz.

18-3. Other Messages

If you tried invalid operations, the following messages will appear.

Indication	Problem
- iLLLEGAL -	You tried to activate a function which can not operate in the current mode of operation (e.g., you pressed AUTO IN/OUT while the REC FUNCTION LED is off).
- rEc ProtEct -	You pressed REC FUNCTION while the tape is write-protected.
- rEc Function -	You tried to record or pressed ID SELECT while the REC FUNCTION LED is off.
- no tc in -	You tried to enter record mode without plugging in any external timecode while the inbuilt timecode generator is off.
- d-in Error -	You tried to record without plugging any source into the digital input while the INPUT select switch is set to DIGITAL.
- bot -	You attempted to let the tape run in reverse by pressing REW etc., while it is at the BOT (Beginning Of Tape).
- Eot -	You attempted to let the tape run in the foward direction by pressing PLAY, F.FWD etc., while it is at the EOT (End Of Tape).
- not LocAl -	Controls are pressed on the DA-60 MKII while REMOTE is pressed on.

SECTION 19 : SPECIFICATIONS

Type : Rotary head digital audio tape recorder

Tape speed : 8.15 mm/sec. (12.225 mm/sec. supported)

Recording/play time : 120 minutes (with 120-minute tape)

Fast-winding time : 60 seconds or less (approx.)(with 120- minute tape)

Error correction : Duplex Reed Solomon code

Channel : 2-channel stereo

Quantization : 16-bit linear

Sampling rate : 44.1 kHz (recording/playback)
48 kHz (recording/playback)

Emphasis : 50 µsec./15 µsec.

Frequency response (recording/playback) : 5 Hz to 22,000 Hz +/-0.5 dB

Signal-to-noise ratio : Better than 94 dB (emphasis Off)
Better than 98 dB (emphasis On)

Dynamic range : Better than 94 dB (emphasis Off)
Better than 98 dB (emphasis On)

Total harmonic distortion : Less than 0.004 % (recording/playback overall, at 1 kHz, at full-scale reading)

Channel separation : Better than 90 dB (at 1 kHz)

Wow and flutter : Unmeasurable (less than +/-0.001 %)

Analog I/O

Line In : XLR-type connector (XLR-3-31) x2 (pin 2 Hot)
Nominal input level : +4 dBm, bal.
Input impedance : 20 kohms

Line Out : XLR-type connector (XLR-3-32) x2 (pin 2 Hot)
Nominal output level : + 4 dBm, bal.
Maximum output level : +20 dBm, bal.
Output impedance : Less than 10 ohms

Monitor Out : RCA jack x2
Nominal output level : -10 dBV, unbal.
Output impedance : Less than 610 ohms

Headphones Out : 1/4" jack x1
Output power : 100 mW + 100 mW (into 8 ohms)

Digital I/O

Input : XLR-type connector (XLR-3-31) x1
Format : IEC958 Type I (AES/EBU)/Type II (SPDIF), auto selection

Output : XLR-type connector (XLR-3-32) x1
Format : IEC958 Type I (AES/EBU)

Timecode I/O

Input : XLR-type connector (XLR-3-31) x1
Nominal input level : 2Vp-p, bal.
Input impedance : 10 kohms

Output : XLR-type connector (XLR-3-32) x1
Nominal output level : 2Vp-p, bal.
Output impedance : 75 ohms

Word sync signal

Input : BNC connector x1
Nominal input level : Equivalent to TTL, unbal.
Input impedance : 75 ohms

Output : BNC connector x1
Nominal output level : Equivalent to TTL, unbal.
Output impedance : 75 ohms

Thru : BNC connector x1
Nominal output level : Equivalent to TTL, unbal.
Output impedance : 75 ohms

Video sync signal

Input : BNC connector x1
Nominal input level : 1 Vp-p, unbal.
Input impedance : 75 ohms

Control interface

ACCESSORY 1 : D-sub 37-pin connector (parallel) x1
Input/output level : Equivalent to TTL

RS-422 : D-sub 9-pin connector (serial) x1

Power requirements :

USA/CANADA : 120 V AC, 60 Hz
U.K./EUROPE : 230 V AC, 50 Hz
AUSTRALIA : 240 V AC, 50 Hz
General Export Model : 120/230/240 V AC, 50/60 Hz switchable

Power consumption :

58 Watts

Dimensions (W x H x D) :

See illustration below.

Weight :

11.5 kg (25-6/16 lbs)

- In these specifications, 0 dBV is referenced to 1 Volt, and 0 dBm is referenced to 0.775 Vrms.
- Changes in specifications and features may be made without notice or obligation.

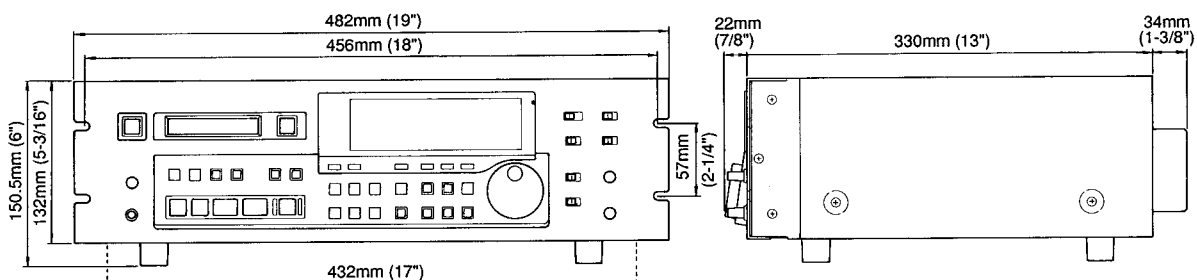

SECTION 20 : OPTIONAL FEATURES OF REFERENCE LEVEL

WARNING

Ask the TASCAM service technician to perform these modifications. Performing these or any other mods yourself places the Warranty in jeopardy.

SMPTE Requirement

For a +4 dBu input signal to cause the level meter to read -20 dB instead of -16 dB as in the original, solder-short-circuit at four points indicated below. Maximum level at the analog output changes from +20 dBu to +24 dBu.

AUDIO PCB Assy

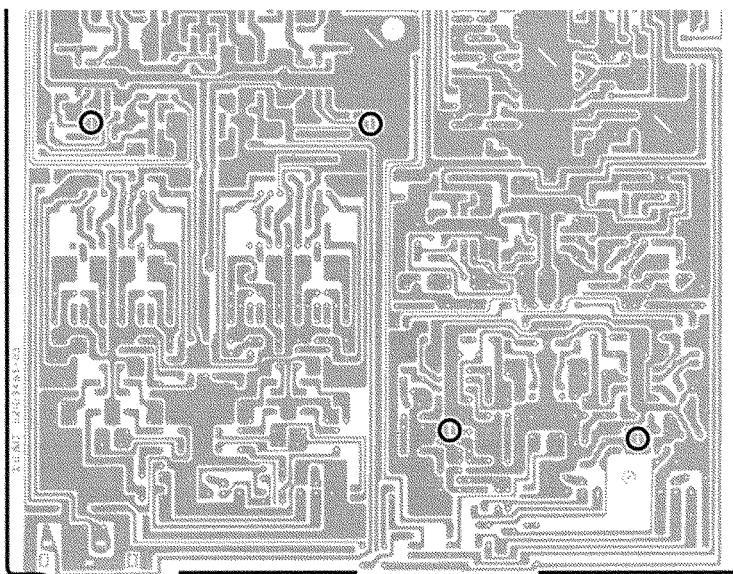

○ : Short-circuit here

EBU Requirement

A +6 dBu input signal causes the level meter to read -9 dB. Maximum level at the analog output changes to +15 dBu.

Cut four jumper wires indicated below.

AUDIO PCB Assy

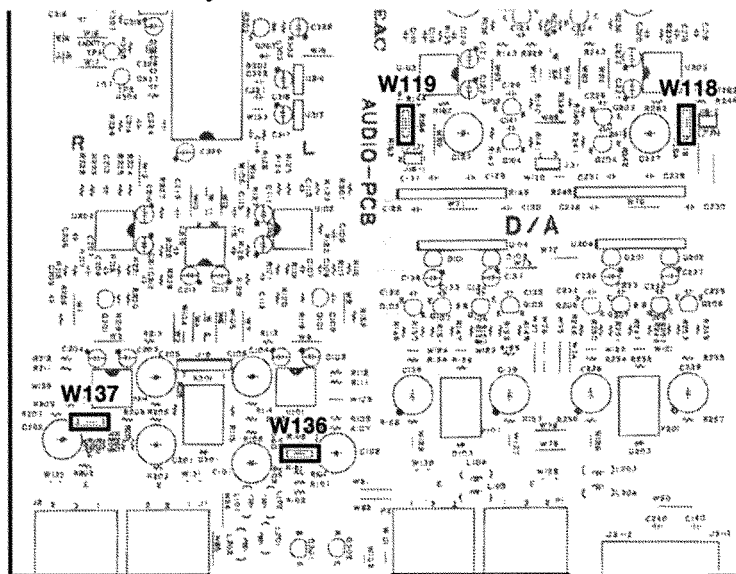

▭ : Cut here

TASCAM

TEAC Professional Division

DA-60MKII

TEAC CORPORATION	3-7-3, Nakacho, Musashino-shi, Tokyo 180, Japan Phone: (0422) 52-5081
TEAC AMERICA, INC.	7733 Telegraph Road, Montebello, California 90640 Phone: (213) 726-0303
TEAC CANADA LTD.	340 Brunel Road, Mississauga, Ontario L4Z 2C2, Canada Phone: 905-890-8008
TEAC UK LIMITED	5 Marlin House, Marlins Meadow, The Croxley Centre, Watford, Herts. WD1 8YA, U.K. Phone: 01923-819699
TEAC DEUTSCHLAND GmbH	Bahnstrasse 12, 65205 Wiesbaden-Erbenheim, Germany Phone: 0611-71580
TEAC FRANCE S.A.	17, Rue Alexis-de-Tocqueville, CE 005 92182 Antony Cedex, France Phone: (1) 42.37.01.02
TEAC NEDERLAND BV	Perkinsbaan 11, 3439 ND Nieuwegein, Nederland Phone: 03-402-30229
TEAC AUSTRALIA PTY., LTD. A.C.N. 005 408 462	106 Bay Street, Port Melbourne, Victoria 3207, Australia Phone: (03) 9644-2442
TEAC ITALIANA S.p.A.	Via C. Cantù 5, 20092 Cinisello Balsamo, Milano, Italy Phone: 02-66010500
