

TASCAM

TEAC Professional Division

3D0031900A

CD-RW700

CD Rewritable Recorder

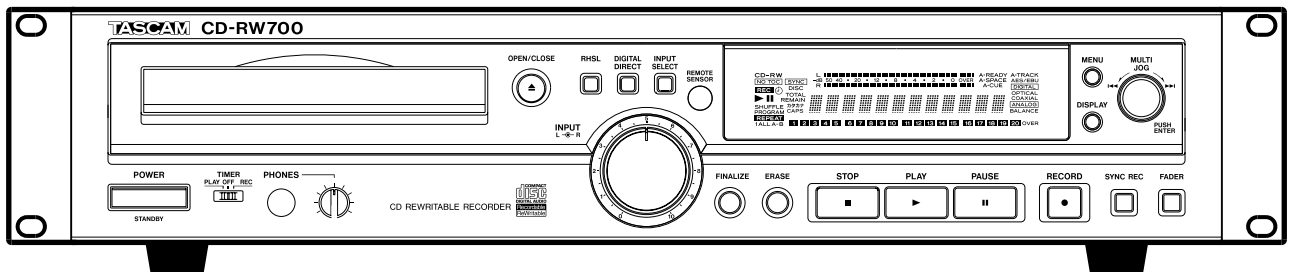

OWNER'S MANUAL



CAUTION
RISK OF ELECTRIC SHOCK
DO NOT OPEN



CAUTION: TO REDUCE THE RISK OF ELECTRIC SHOCK, DO NOT REMOVE COVER (OR BACK). NO USER-SERVICEABLE PARTS INSIDE. REFER SERVICING TO QUALIFIED SERVICE PERSONNEL.



The lightning flash with arrowhead symbol, within an equilateral triangle, is intended to alert the user to the presence of uninsulated "dangerous voltage" within the product's enclosure that may be of sufficient magnitude to constitute a risk of electric shock to persons..



The exclamation point within an equilateral triangle is intended to alert the user to the presence of important operating and maintenance (servicing) instructions in the literature accompanying the appliance.

This appliance has a serial number located on the rear panel. Please record the model number and serial number and retain them for your records.
Model number _____
Serial number _____

WARNING: TO PREVENT FIRE OR SHOCK HAZARD, DO NOT EXPOSE THIS APPLIANCE TO RAIN OR MOISTURE.

Important Safety Precautions

Note for U.K. Customers

DO NOT cut off the mains plug from this equipment.

If the plug fitted is not suitable for the power points in your home or the cable is too short to reach a power point, then obtain an appropriate safety approved extension lead or consult your dealer.

If nonetheless the mains plug is cut off, remove the fuse and dispose of the plug immediately, to avoid a possible shock hazard by inadvertent connection to the mains supply.

If this product is not provided with a mains plug, or one has to be fitted, then follow the instructions given below:

IMPORTANT: DO NOT make any connection to the larger terminal which is marked with the letter E or by the safety earth symbol \perp or coloured GREEN or GREEN-and-YELLOW.

The wires in the mains lead on this product are coloured in accordance with the following code:

BLUE : **NEUTRAL**
BROWN : **LIVE**

As these colours may not correspond with the coloured markings identifying the terminals in your plug proceed as follows:

The wire which is coloured BLUE must be connected to the terminal which is marked with the letter N or coloured BLACK.

The wire which is coloured BROWN must be connected to the terminal which is marked with the letter L or coloured RED.

When replacing the fuse only a correctly rated approved type should be used and be sure to re-fit the fuse cover.

IF IN DOUBT — CONSULT A COMPETENT ELECTRICIAN.

For U.S.A

TO THE USER

This equipment has been tested and found to comply with the limits for a Class B digital device, pursuant to Part 15 of the FCC Rules. These limits are designed to provide reasonable protection against interference in a residential area. This device generates and uses radio frequency energy and if not installed and used in accordance with the instructions, it may cause interference to radio or TV reception. If this unit does cause interference with TV or radio reception you can try to correct the interference by one or more of the following measures:

- a) Reorient or relocate the receiving antenna.
 - b) Increase the separation between the equipment and the receiver.
 - c) Plug the equipment into a different outlet so that it is not on the same circuit as the receiver.
- If necessary, consult the dealer or an experienced radio/TV technician for additional suggestions.

CAUTION

Changes or modifications to this equipment not expressly approved by TEAC CORPORATION for compliance could void the user's authority to operate

For the consumers in Europe

WARNING

This is a Class A product. In a domestic environment, this product may cause radio interference in which case the user may be required to take adequate measures.

Pour les utilisateurs en Europe

AVERTISSEMENT

Il s'agit d'un produit de Classe A. Dans un environnement domestique, cet appareil peut provoquer des interférences radio, dans ce cas l'utilisateur peut être amené à prendre des mesures appropriées.

Für Kunden in Europa

Warnung

Dies ist eine Einrichtung, welche die Funk-Entstörung nach Klasse A besitzt. Diese Einrichtung kann im Wohnbereich Funkstörungen verursachen ; in diesem Fall kann vom Betreiber verlangt werden, angemessene Maßnahmen durchzuführen und dafür aufzukommen.

IMPORTANT SAFETY INSTRUCTIONS

CAUTION:

- Read all of these Instructions.
- Save these Instructions for later use.
- Follow all Warnings and Instructions marked on the audio equipment.

- 1) Read Instructions** — All the safety and operating instructions should be read before the product is operated.
- 2) Retain Instructions** — The safety and operating instructions should be retained for future reference.
- 3) Heed Warnings** — All warnings on the product and in the operating instructions should be adhered to.
- 4) Follow Instructions** — All operating and use instructions should be followed.
- 5) Cleaning** — Unplug this product from the wall outlet before cleaning. Do not use liquid cleaners or aerosol cleaners. Use a damp cloth for cleaning.
- 6) Attachments** — Do not use attachments not recommended by the product manufacturer as they may cause hazards.
- 7) Water and Moisture** — Do not use this product near water — for example, near a bath tub, wash bowl, kitchen sink, or laundry tub; in a wet basement; or near a swimming pool; and the like.
- 8) Accessories** — Do not place this product on an unstable cart, stand, tripod, bracket, or table. The product may fall, causing serious injury to a child or adult, and serious damage to the product. Use only with a cart, stand, tripod, bracket, or table recommended by the manufacturer, or sold with the product. Any mounting of the product should follow the manufacturer's instructions, and should use a mounting accessory recommended by the manufacturer.
- 9) A product and cart combination should be moved with care.** Quick stops, excessive force, and uneven surfaces may cause the product and cart combination to overturn.



- 10) Ventilation** — Slots and openings in the cabinet are provided for ventilation and to ensure reliable operation of the product and to protect it from overheating, and these openings must not be blocked or covered. The openings should never be blocked by placing the product on a bed, sofa, rug, or other similar surface. This product should not be placed in a built-in installation such as a bookcase or rack unless proper ventilation is provided or the manufacturer's instructions have been adhered to.
- 11) Power Sources** — This product should be operated only from the type of power source indicated on the marking label. If you are not sure of the type of power supply to your home, consult your product dealer or local power company. For products intended to operate from battery power, or other sources, refer to the operating instructions.
- 12) Grounding or Polarization** — This product may be equipped with a polarized alternating-current line plug (a plug having one blade wider than the other). This plug will fit into the power outlet only one way. This is a safety feature. If you are unable to insert the plug fully into the outlet, try reversing the plug. If the plug should still fail to fit, contact your electrician to replace your obsolete outlet. Do not defeat the safety purpose of the polarized plug.
- 13) Power-Cord Protection** — Power-supply cords should be routed so that they are not likely to be walked on or pinched by items placed upon or against them, paying particular attention to cords at plugs, convenience receptacles, and the point where they exit from the product.
- 14) Outdoor Antenna Grounding** — If an outside antenna or cable system is connected to the product, be sure the antenna or cable system is grounded so as to provide some protection against voltage surges and built-up static charges. Article 810 of the National Electrical Code, ANSI/NFPA 70, provides information with regard to proper grounding of the mast and supporting structure, grounding of the lead-in wire to an antenna discharge unit, size of grounding conductors, location of antenna-discharge unit, connection to grounding electrodes, and requirements for the grounding electrode.

"Note to CATV system installer:

This reminder is provided to call the CATV system installer's attention to Section 820-40 of the NEC which provides guidelines for proper grounding and, in particular, specifies that the cable ground shall be connected to the grounding system of the building, as close to the point of cable entry as practical.

Example of Antenna Grounding as per National Electrical Code, ANSI/NFPA 70

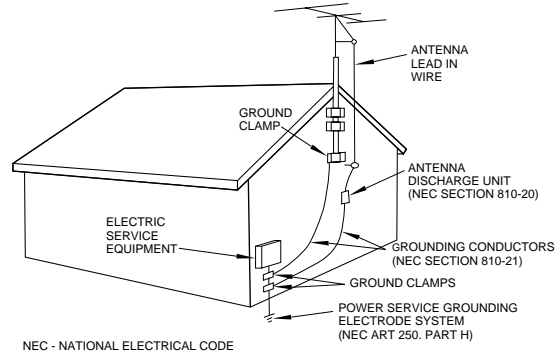

- 15) Lightning** — For added protection for this product during a lightning storm, or when it is left unattended and unused for long periods of time, unplug it from the wall outlet and disconnect the antenna or cable system. This will prevent damage to the product due to lightning and power-line surges.
- 16) Power Lines** — An outside antenna system should not be located in the vicinity of overhead power lines or other electric light or power circuits, or where it can fall into such power lines or circuits. When installing an outside antenna system, extreme care should be taken to keep from touching such power lines or circuits as contact with them might be fatal.
- 17) Overloading** — Do not overload wall outlets, extension cords, or integral convenience receptacles as this can result in risk of fire or electric shock.
- 18) Object and Liquid Entry** — Never push objects of any kind into this product through openings as they may touch dangerous voltage points or short-out parts that could result in a fire or electric shock. Never spill liquid of any kind on the product.
- 19) Servicing** — Do not attempt to service this product yourself as opening or removing covers may expose you to dangerous voltage or other hazards. Refer all servicing to qualified service personnel.
- 20) Damage Requiring Service** — Unplug this product from the wall outlet and refer servicing to qualified service personnel under the following conditions:
 - a) when the power-supply cord or plug is damaged.
 - b) if liquid has been spilled, or objects have fallen into the product.
 - c) if the product has been exposed to rain or water.
 - d) if the product does not operate normally by following the operating instructions. Adjust only those controls that are covered by the operating instructions as an improper adjustment of other controls may result in damage and will often require extensive work by a qualified technician to restore the product to its normal operation.
 - e) if the product has been dropped or damaged in any way.
 - f) when the product exhibits a distinct change in performance — this indicates a need for service.
- 21) Replacement Parts** — When replacement parts are required, be sure the service technician has used replacement parts specified by the manufacturer or have the same characteristics as the original part. Unauthorized substitutions may result in fire, electric shock, or other hazards.
- 22) Safety Check** — Upon completion of any service or repairs to this product, ask the service technician to perform safety checks to determine that the product is in proper operating condition.
- 23) Wall or Ceiling Mounting** — The product should be mounted to a wall or ceiling only as recommended by the manufacturer.
- 24) Heat** — The product should be situated away from heat sources such as radiators, heat registers, stoves, or other products (including amplifiers) that produce heat.

SAFETY INFORMATION

This product has been designed and manufactured according to FDA regulations "title 21, CFR, chapter 1, subchapter J, based on the Radiation Control for Health and Safety Act of 1968", and is classified as a class 1 laser product. There is no hazardous invisible laser radiation during operation because invisible laser radiation emitted inside of this product is completely confined in the protective housings.

The label required in this regulation is shown ①.

CAUTION

- DO NOT REMOVE THE PROTECTIVE HOUSING USING A SCREWDRIVER.
- USE OF CONTROLS OR ADJUSTMENTS OR PERFORMANCE OF PROCEDURES OTHER THAN THOSE SPECIFIED HEREIN MAY RESULT IN HAZARDOUS RADIATION EXPOSURE.
- IF THIS PRODUCT DEVELOPS TROUBLE, CONTACT YOUR NEAREST QUALIFIED SERVICE PERSONNEL, AND DO NOT USE THE PRODUCT IN ITS DAMAGED STATE.

Voltage Conversion

(General export models only)

Be sure to remove the power cord from the AC outlet before repositioning the voltage converter switch.

1. Locate the voltage selector on the rear panel.
2. Using a flat-bladed screwdriver, set to the appropriate 230V or 120V position according to your area.

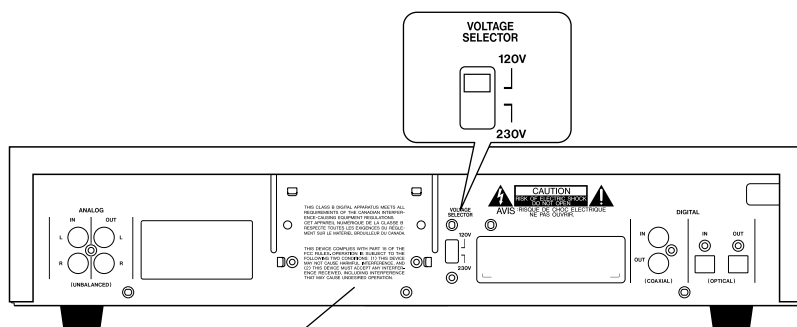

①

CERTIFICATION
THIS PRODUCT COMPLIES WITH DHHS
RULES 21 CFR SUBCHAPTER J APPLI
CABLE AT DATE OF MANUFACTURE
TEAC CORPORATION
3-7-3 NAKA-CHO, MUSASHINO-SHI, TOKYO, JAPAN
MANUFACTURED TIF

For U.S.A.

Optical pickup: Type : KRS-202A or KRS-220B

Manufacturer : SONY Corporation

Laser output : Less than 0.1 mW (Play) and 32 mW
(Record) on the objective lens

Wavelength : 777 - 787 nm

For CANADA

AC POWER CORD CONNECTION

CAUTION:

TO PREVENT ELECTRIC SHOCK, MATCH WIDE BLADE OF
PLUG TO WIDE SLOT, FULLY INSERT.

Pour le CANADA

CORDE DE CONNEXION CA

ATTENTION:

POUR ÉVITER LES CHOCS ÉLECTRIQUES, INTRODUIRE LA
LAME LA PLUS LARGE DE LA FICHE DANS LA BORNE
CORRESPONDANTE DE LA PRISE ET POUSSER JUSQU'AU
FOND.

1 - Introduction

1.1	About CD-R and CD-RW discs	6
1.2	Finalizing	7
1.2.1	“Recordable” discs	7
1.2.2	About this manual	7
1.3	Unpacking the CD-RW700	7
1.3.1	Rack-mounting the unit	7
1.4	Environmental considerations	7
1.4.1	Beware of condensation	8
1.4.2	Never use a stabilizer or printable discs	8
1.4.3	Handling of compact discs	8
1.4.4	Additional notes with regard to CD-R and CD-RW discs	8
1.4.5	Recommended media	9
1.4.6	Default settings	9
1.4.7	Dimensional drawing	9

2 - Features of the CD-RW700

2.1	Front panel	11
①	POWER switch (STANDBY/ON)	11
②	Disc tray	11
③	OPEN/CLOSE key	11
④	RHSL key	11
⑤	DIGITAL DIRECT	11
⑥	INPUT SELECT	11
⑦	REMOTE SENSOR	11
⑧	Display	11
⑨	MENU key	11
⑩	DISPLAY key	11
⑪	MULTI JOG control	11
⑫	TIMER switch (PLAY, OFF, REC)	11
⑬	PHONES jack and LEVEL control	11
⑭	REC LEVEL controls	11
⑮	FINALIZE key	11
⑯	ERASE key	11
⑰	STOP key	12
⑱	PLAY key	12
⑲	PAUSE key	12
⑳	RECORD key	12
㉑	SYNC REC key	12
㉒	FADER key	12
2.2	Rear panel	12
㉓	ANALOG IN (L, R) (UNBALANCED)	12
㉔	ANALOG OUT (L, R) (UNBALANCED)	12
㉕	DIGITAL COAXIAL (IN, OUT)	12
㉖	DIGITAL OPTICAL (IN, OUT)	12
2.3	Remote control unit	12
①	POWER key	12
②	OPEN/CLOSE key	12
③	Number keys (0 through 10 and +10)	12
④	CLEAR key	12
⑤	REPEAT key	12
⑥	DISPLAY key	12
⑦	MENU key	12
⑧	ENTER key	12
⑨	FADER key	12
⑩	MONITOR key	12
⑪	PLAY MODE key	12
⑫	FINALIZE key	12

⑬	ERASE key	12
⑭	RECORD key	12
⑮	SYNC REC key	13
⑯	REC MUTE key	13
⑰	SEARCH keys	13
⑱	SKIP keys	13
⑲	STOP key	13
⑳	PAUSE key	13
㉑	PLAY key	13
2.3.1	Use of the remote control unit	13
2.4	Connections	13
2.5	Timer operations	13
2.5.1	Setting the clock	13
2.5.2	Setting the timer	14
2.5.3	Using the timer	14

3 - Playback operations

3.1	Simple playback operations	15
3.1.1	Time display modes	15
3.1.2	Track search	15
3.1.3	Playback modes	15
3.2	Programmed order playback	16
3.3	Repeat play	16

4 - Recording

4.1	Input selection	17
4.1.1	Signal volume	17
4.1.2	Input monitoring	17
4.1.3	Frequency conversion	17
4.2	Basic recording	18
4.2.1	Playing back tracks	18
4.2.2	Time display while recording	18
4.2.3	Manual track division	19
4.2.4	Restricting the number of tracks	19
4.2.5	Full disc	19
4.3	Advanced recording	19
4.3.1	Synchronized recording	19
4.3.2	Automatic track division	21
4.3.3	SCMS and the CD-RW700	22
4.3.4	Digital direct	22
4.3.5	Rec mute function	23
4.3.6	Fade-in and fade-out	23
4.4	Rehearsal	23
4.4.1	Rehearsal for synchronized recording	24
4.4.2	Rehearsal for track division	25

5 - After recording

5.1	Finalizing	26
5.1.1	Unfinalizing CD-RW discs	26
5.2	Erasing	26
5.2.1	Erasing tracks	26
5.2.2	Erasing a whole disc	27
5.2.3	Refreshing a disc	27

6 - Reference and specifications

6.1	Troubleshooting	28
6.2	Specifications	28

1 - Introduction

The CD-RW700 CD rewritable recorder allows you to make your own CDs from a variety of sources—other CDs, MD recordings, analog cassette tapes, and records.

Tracks can be recorded all at one time, or added, until the disc is “finalized”, allowing it to be played on CD players.

NOTE

Some models of CD player may be unable to play certain discs produced using the CD-RW700.

A variety of sophisticated features are incorporated in the CD-RW700, allowing a wide degree of flexibility.

The CD-RW700 provides analog unbalanced audio inputs and outputs for connection to –10 dBV equipment.

In addition, coaxial and optical inputs and outputs are provided for recording from and playing back to suitably-equipped digital audio equipment.

The analog and digital signals may be mixed, allowing unprecedented versatility while recording.

24-bit digital-to-analog and analog-to-digital converters provide excellent recording and playback quality.

A sampling frequency convertor is incorporated, allowing the recording of CDs from digital audio sources which are at frequencies other than the CD standard sampling frequency of 44.1 kHz.

Track divisions can be entered manually, or can produced automatically as a response to the input signal level.

A recording buffer ensures that even the first milliseconds of a track are recorded, and a rehearsal mode allows the precise positioning of track divisions, allowing the elimination of false starts or late entries.

“One-touch” fade-ins and fade-outs over a specified time allow you to edit program material to your specific requirements.

A multi-function “multi jog” dial is used to set and confirm parameter settings.

A wireless remote control unit allows control of the CD-RW700 from remote locations.

NOTE

This product is designed to help you record and reproduce sound works to which you own the copyright, or where you have obtained permission from the copyright holder or the rightful licensor. Unless you own the copyright, or have obtained the appropriate

permission from the copyright holder or the rightful licensor, your unauthorized recording, reproduction or distribution thereof may result in severe criminal penalties under copyright laws and international copyright treaties. If you are uncertain about your rights, contact your legal advisor. Under no circumstances will TEAC Corporation be responsible for the consequences of any illegal copying performed using the CD-RW700.

1.1 About CD-R and CD-RW discs

The CD-RW700 uses CD-R and CD-RW Digital media.

CD-R discs can be recorded once only. Once they have been used for recording, they cannot be erased or re-recorded. However, if space is available on the disc, additional material can be recorded. The packaging of CD-R discs will include the following logo:



By contrast, a CD-RW disc can be used in much the same way as a CD-R disc, but the last track or tracks recorded can be erased before the disc has been “finalized”, and the space on the disc can be re-used for other recordings. The packaging of CD-RW discs will include the a logo similar to the following:



However, you should note that an audio CD created using a CD-RW disc may not play back satisfactorily on every audio CD player. It will, naturally, be playable on the CD-RW700. This is in no way a limitation of the CD-RW700 itself, but of the difference between the different types of media and the methods used to read them.

CD-R discs created on the CD-RW700, by contrast, may be played satisfactorily on the majority of audio CD players.

For details of disc brands that are known to work well with the CD-RW700, see 1.4.5, “Recommended media”.

1.2 Finalizing

Although audio data may be written on a CD-R or CD-RW disc, a standard CD player will not be able to read the data (i.e. play back the audio) until a final table of contents (TOC) has been written at the start of the disc.

The process of writing this table of contents is known as “finalizing”. Once this has been done, no further data can be written to the disk. See 5.1, “Finalizing” for details.

In the case of a CD-RW disc which has been finalized, the whole of the disc may be erased, or the disc may be “refreshed”, and the disc re-used.

In addition, a CD-RW disc that has been finalized may be “unfinalized”, i.e. the TOC is removed. This allows further tracks to be recorded to the disc, provided that there is space on the disc.

1.2.1 “Recordable” discs

In this manual, we use the term “recordable” disc to describe a CD-R or CD-RW disc that has not been finalized, i.e. further recording is possible on the disc.

1.2.2 About this manual

In this manual, we use the following conventions:

- The names of keys and controls are given in the following typeface: **ERASE**.
- When the alphanumeric portion of the display shows a message, this is shown in the following typeface: `Welc ome`.
- If a preset indicator in the display (i.e. one which cannot change, but is either on or off) is shown, this is shown as follows: SHUFFLE.
- When referring to a front or rear panel control or feature, the following typeface is used to show the number of the feature (as given in the diagram in this manual, and the corresponding explanation): ⑤.
- When referring to a remote control key, the following typeface is used to show the number of the key (as given in the diagram in this manual, and the corresponding explanation): ⑤.

1.3 Unpacking the CD-RW700

When unpacking the unit, you should find the following items, in addition to this manual:

- The main unit itself
- The remote control unit
- Two AA batteries for the remote control unit
- A rack-mounting screw kit

1.3.1 Rack-mounting the unit

Use the rack-mounting kit to mount the unit in a standard 19-inch equipment rack, as shown below. Remove the feet of the unit before mounting it.

See 1.4, “Environmental considerations” below for details of ventilation, etc.

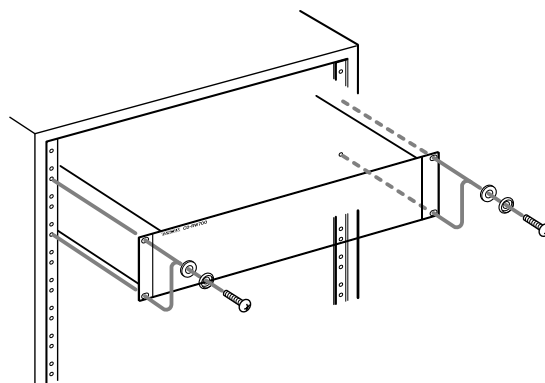

1.4 Environmental considerations

The CD-RW700 may be used in most areas, but to maintain top performance, and prolong operating life, observe the following environmental conditions:

The nominal temperature should be between 5°C and 35°C (41°F and 95°F). The CD-RW700 is more sensitive to extremes of temperature than ordinary CD players.

Relative humidity should be 30 to 90 degrees non-condensing.

As the unit may become hot during operation, always leave sufficient space above the unit for ventilation. If you are mounting the unit in a rack, leave 1U of space above it.

You should not place the unit on a piece of equipment generating heat, e.g. an amplifier, to avoid possible problems with overheating.

Make sure that the unit is mounted in a level position for correct operation. Do not mount the unit in a rack tilted 5° or more from the vertical position.

1 • Introduction—Environmental considerations

NOTE

If the mounting surface is more than 5 degrees away from the horizontal, it will not open or close.

The voltage supplied to the unit should match the voltage as printed on the rear panel. If you are in any doubt regarding this matter, consult an electrician.

NOTE

When transporting the unit, always use the original packing materials. For this reason, we strongly recommend that you save all the packing materials that came with the CD-RW700, in case you need to transport it in the future.

In addition, when transporting the unit, you should tape the disc tray closed, using an adhesive tape that will not spoil the finish of the unit.

1.4.1 Beware of condensation

If the unit (or a compact disc) is moved from a cold to a warm place, or used after a sudden temperature change, there is a danger of condensation; vapor in the air could condense on the internal mechanism, making correct operation impossible. To prevent this, or if this occurs, leave the player for one or two hours with the power turned on, then turn the power off and on again.

1.4.2 Never use a stabilizer or printable discs

Using commercially available CD stabilizers or printable recordable discs with this player will damage the mechanism and cause it to malfunction.

NOTE

Never use a disc that has had a stabilizer mounted to it. The residual adhesive may cause the disc to stick to the mechanism of the CD-RW700. If it sticks to the mechanism, you will need a technician to get it out.

1.4.3 Handling of compact discs

Observe the following:

- Always place the compact discs in the trays with their label facing upward (compact discs can only be played on one side).
- To remove a disc from its storage case, press down on the center of the case, and lift the disc out, holding it carefully by the edges.

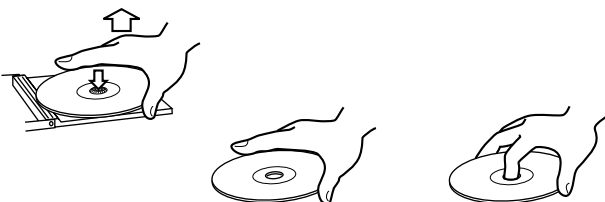

- Finger marks and dust should be carefully wiped off the disc's recorded surface with a soft cloth. Unlike conventional records, the compact disc has no grooves to collect dust and microscopic debris, so gently wiping with a soft cloth should remove most particles.
- Wipe in a straight motion from the inside to the outside of the disc. Small dust particles and light stains will have absolutely no effect on reproduction quality.



- Never use such chemicals as record sprays, anti-static sprays or fluid, benzine or thinner to clean compact discs. Such chemicals will do irreparable damage to the disc's plastic surface.
- Discs should be returned to their cases after use to avoid serious scratches that could cause the laser pickup to "skip".
- Don't expose discs to direct sunlight or high humidity and temperature for extended periods. Long exposure to high temperature can warp the disc.
- Only use circular compact discs. Avoid using non-circular promotional, etc. discs.

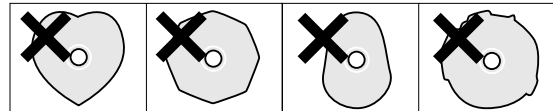

- To keep the laser pickups clean, don't touch them. For the same reason, don't leave the disc trays opened unnecessarily.

1.4.4 Additional notes with regard to CD-R and CD-RW discs

There are additional precautions that you should take when handling CD-R and CD-RW discs, that are different to those that you should take when handling ordinary CDs.

- Avoid touching the recording (non-label) side of a disc on which you will be recording. Recording on a disc requires a cleaner surface than playing back, and fingerprints, grease, etc. can cause errors in the recording process.
- CD-R discs are more sensitive to the effects of heat and ultraviolet rays than ordinary CDs. It is important that they are not stored in a location where

1 • Introduction—Environmental considerations

direct sunlight will fall on them, and which is away from sources of heat such as radiators or heat-generating electrical devices.

- Always store CD-R discs in their “jewel cases” to avoid dirt and dust accumulating on their surfaces.
- Do not put labels or protective sheets on the discs and do not use any protective coating spray.
- When labeling CD-R discs, always use a soft oil-based felt-tipped pen to write the information. Never use a ball-point or hard-tipped pen, as this may cause damage to the recorded side.
- Dirty discs may be cleaned using a soft dry cloth and/or a commercial CD cleaning fluid or ethyl alcohol. Do not use thinner, gasoline, benzene or LP cleaning fluid, as these will damage the disc.
- If you are in any doubt as to the care and handling of a CD-R disc, read the precautions supplied with the disc, or contact the disc manufacturer directly.

1.4.5 Recommended media

An up-to-date list of manufacturers who produce media suitable for use in the CD-RW700 can be

obtained from your TASCAM dealer, or found on the TASCAM Web site at <http://www.tascam.com>.

1.4.6 Default settings

The default settings when the CD-RW700 is shipped from the factory are given below.

Setting	Description	Default value
Digital direct (D_DIRECT)	4.3.4, “Digital direct”	Off
Input selection (A_TRACK)	4.1, “Input selection”	Analog
Auto track (A_TRACK)	4.3.2, “Automatic track division”	On
Trigger level (S_LEVEL)	4.3.1, “Synchronized recording”	-54 dB
FADE IN time	4.3.6, “Fade-in and fade-3 seconds out”	
FADE OUT time	4.3.6, “Fade-in and fade-3 seconds out”	
Volume (DIGITAL IN)	4.1.1, “Signal volume”	0 dB
Volume (ANALOG IN)	4.1.1, “Signal volume”	0 dB
Timer on/off times	2.5.2, “Setting the timer”	Unset
Play mode	3.1.3, “Playback modes”	Continue
Trim	4.4, “Rehearsal”	±0 frames

1.4.7 Dimensional drawing

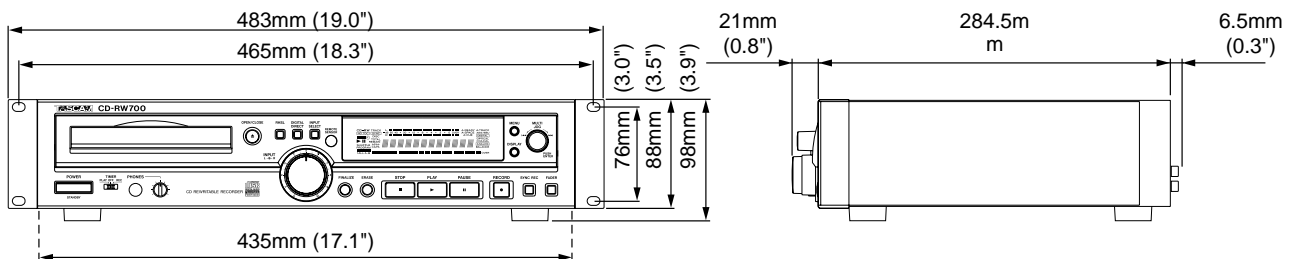

2 - Features of the CD-RW700

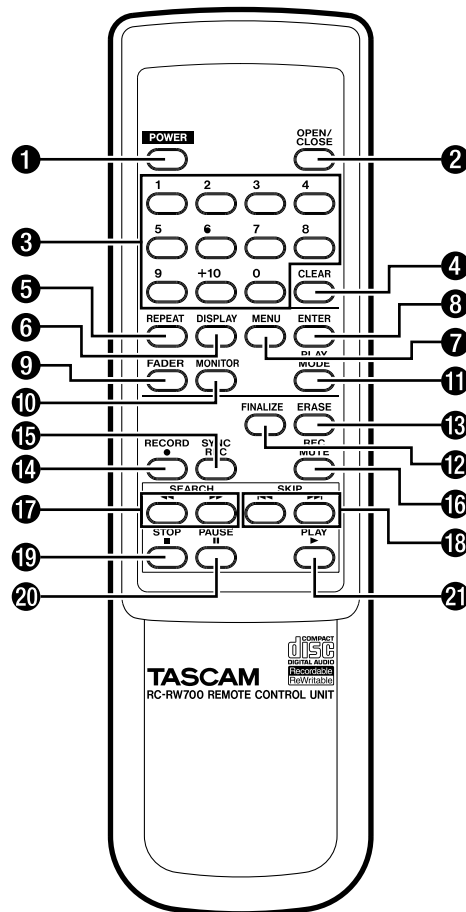
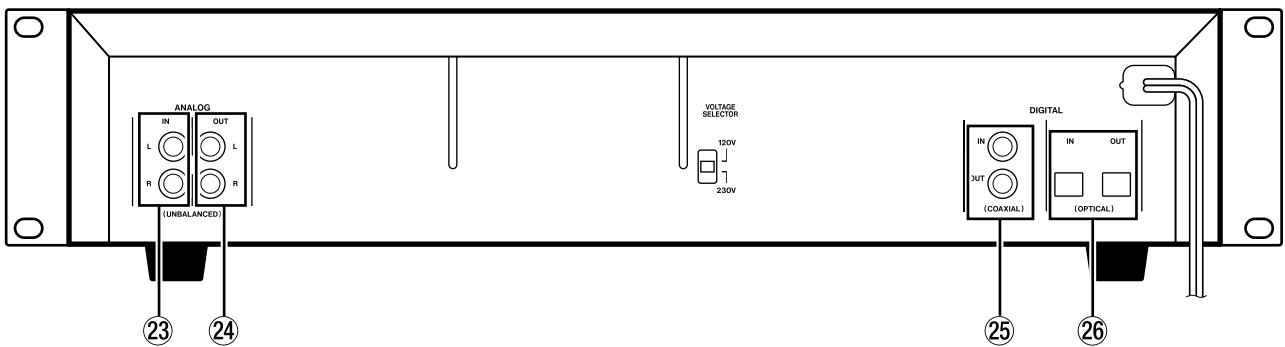
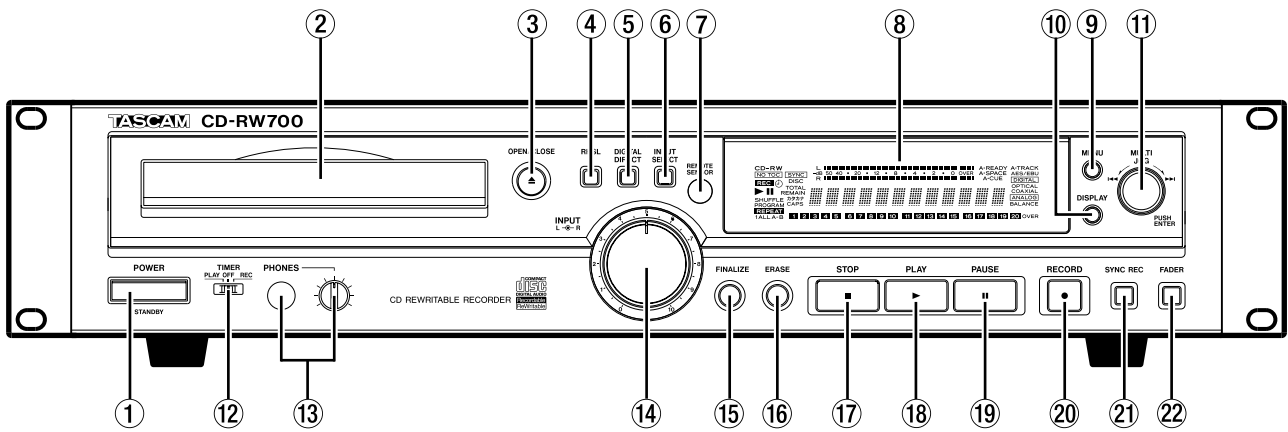

2.1 Front panel

① POWER switch (STANDBY/ON)

The power switch is used to switch the unit between standby mode (the time from the internal clock is displayed) and on (full operational mode).

When the unit is turned on, the display shows `Welcome!`.

② Disc tray

Discs should be placed label side upwards in the disc tray.

When a disc is loaded into the unit, the display briefly shows `TOC Reading.`, with a flashing period following the word “Reading” as the unit determines the contents of the disc.

③ OPEN/CLOSE key

Use this key to open and close the disc tray. The display shows `OPEN` when the tray is opening and `CLOSE` when the tray is closing.

④ RHSL key

Use this key when recording to set and adjust the start point of a recording session or the start of a track on the recorded disc. See 4.4, “Rehearsal” for details.

⑤ DIGITAL DIRECT

When this is active, any digital audio signals input to the unit bypass the frequency convertor and the digital volume control. See 4.3.4, “Digital direct” for details

⑥ INPUT SELECT

Repeated presses of this key cycle through the different audio inputs and the input combinations. See 4.1, “Input selection” for full details.

⑦ REMOTE SENSOR

This is not a control, but the sensor for the remote control unit. When using the remote control unit, make sure that there is a clear path from the remote control unit to the sensor.

⑧ Display

The display is used to show the current status of the unit, as well as the current menu settings. See 2.2, “Rear panel” for details.

⑨ MENU key

Repeated presses of this key cycle through the different menu items used to set parameters.

⑩ DISPLAY key

Repeated presses of this key cycle through the different time display modes. These modes differ, according to whether the unit is playing back or recording a disc.

⑪ MULTI JOG control

Use this control to select tracks for playback, to set parameter values, etc.

Typically, turning the control clockwise will increase a value, and turning it counterclockwise will decrease the value. There is no “end-stop” to the control—it may be turned continuously in either direction.

In addition, pushing the control acts like an “enter” key, i.e. the currently-displayed value or setting is confirmed.

⑫ TIMER switch (PLAY, OFF, REC)

Use this switch with the timer functions to control the behavior of the unit when the timer “on” time is reached. See 2.5, “Timer operations” for details.

⑬ PHONES jack and LEVEL control

Use a standard pair of stereo headphones, equipped with a 1/4-inch plug, with this jack.

Adjust the volume from the jack with the control (turn clockwise for higher volume).

⑭ REC LEVEL controls

Use these concentric controls to adjust the level of the analog audio signals received at the **ANALOG IN** jacks ⑳. Typically, turning one of these controls will cause the other to turn, but they can be turned independently of each other.

Use the lower (outer) control to adjust the left signal, and the upper (inner) control to adjust the right signal.

Turning the controls clockwise past the “5” position will boost the signals relative to their input level, and turning them counterclockwise to a position below “5” will cut the signals relative to their original input level.

⑮ FINALIZE key

Use this key to finalize recordable discs. See 1.2, “Finalizing” and 5.1, “Finalizing” for details.

⑯ ERASE key

Use this key (with CD-RW discs only) to erase tracks, or a whole disc, or to refresh a “bad” disc, or

2 • Features of the CD-RW700—Rear panel

to unfinalize a finalized disc. See 5.2, “Erasing” for details.

17 STOP key

Use this key to stop playback or recording.

18 PLAY key

Use this key to start or resume playback or recording.

19 PAUSE key

Use this key to pause playback or recording.

20 RECORD key

Use this key to enter record ready mode (see 4, “Recording” for details) and also to enter manual track divisions (see 4.2.3, “Manual track division”).

21 SYNC REC key

Use this key to turn synchronized recording on and off (see 4.3.1, “Synchronized recording” for details).

22 FADER key

Use this key to start fade-in recordings or to start a fade-out when recording (see 4.3.6, “Fade-in and fade-out” for details).

2.2 Rear panel

23 ANALOG IN (L, R) (UNBALANCED)

These RCA jacks accept analog audio signals from suitably-equipped units (–10 dBV, unbalanced).

24 ANALOG OUT (L, R) (UNBALANCED)

These RCA jacks output analog audio signals (at –10 dBV levels, unbalanced) to suitably-equipped units.

25 DIGITAL COAXIAL (IN, OUT)

These two RCA jacks accept and output digital audio in standard consumer format (SPDIF).

26 DIGITAL OPTICAL (IN, OUT)

These two TOSLINK optical connectors accept and output digital audio using optical fiber connectors.

2.3 Remote control unit

1 POWER key

Use this to turn the unit between off and standby modes (equivalent to ①).

2 OPEN/CLOSE key

Opens and closes the disc tray (equivalent to ③).

3 Number keys (0 through 10 and +10)

Use these keys for direct entry of track numbers when playing back, or making a programmed play list.

4 CLEAR key

Use this key to clear a mistaken entry made with the number keys.

5 REPEAT key

Use this key to change between the various repeat modes when playing back (see 3.3, “Repeat play”).

6 DISPLAY key

Use this key to switch between the different display modes available (equivalent to ⑩).

7 MENU key

Repeated presses of this key cycle through the different menu items used to set parameters (equivalent to ⑨).

8 ENTER key

Pressing this key is equivalent to pressing the **MULTI JOG** control ⑪ to confirm an entry.

9 FADER key

Use this key to start fade-in recordings or to start a fade-out when recording (equivalent to ⑫).

10 MONITOR key

Use this key to output the signals received at the currently selected input(s) through the outputs when not recording or in record ready mode.

11 PLAY MODE key

Use this key to choose between the different playback modes (single play, continue play, etc.).

12 FINALIZE key

Use this key to finalize recordable discs. See 1.2, “Finalizing” and 5.1, “Finalizing” for details (equivalent to ⑮).

13 ERASE key

Use this key (with CD-RW discs only) to erase tracks, or a whole disc, or to refresh a “bad” disc, or to unfinalize a finalized disc. See 5.2, “Erasing” for details (equivalent to ⑯).

14 RECORD key

Use this key to enter record ready mode (equivalent to ⑳).

2 • Features of the CD-RW700—Connections

15 SYNC REC key

Use this key to turn synchronized recording on and off (equivalent to 21). See 4.3.1, “Synchronized recording” for details.

16 REC MUTE key

Use this key when recording, to mute the input signal for about four seconds and then to enter record ready mode (see 4.3.5, “Rec mute function”).

17 SEARCH keys

Use these keys to move the playback position inside a track.

18 SKIP keys

Use these keys to move between tracks when playing back (equivalent to turning 11). They are also used to set the parameter values, etc.

19 STOP key

Use this key to stop playback or recording (equivalent to 17).

20 PAUSE key

Use this key to pause playback or recording (equivalent to 19).

21 PLAY key

Use this key to start playback, or enter record mode from record ready mode (equivalent to 18).

2.3.1 Use of the remote control unit

When using the remote control unit, make sure:

- There is a clear unobstructed path between the remote control unit and the remote sensor 7 on the main unit.
- The remote control unit is located within 5 m (15 ft.) of the main unit, and is pointing at approximately right angles ($\pm 30^\circ$) to the front panel.

When fitting or replacing the batteries:

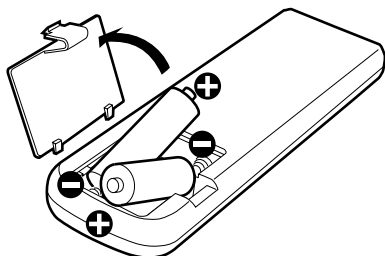

- Always make sure that both batteries are replaced together. Do not mix old and new batteries.
- Do not mix batteries of different types.
- Always make sure that the batteries are located with the correct polarity (the positive terminals of

the batteries should match the + markings inside the battery compartment, and the negative terminals should match the – markings).

- If you are not going to use the remote control unit for an extended period of time, remove the batteries. Old batteries can leak, causing damage to the remote control unit.
- Always dispose of old batteries in the way recommended by your local garbage disposal authorities.

2.4 Connections

The following should be noted when you connect the unit to other equipment.

It is possible to connect the unit's **DIGITAL COAXIAL IN** 25 and **DIGITAL OPTICAL IN** 26 to other equipment at the same time. However, the unit can receive signals from only one digital input at a time.

Audio signals output from the unit are output from the **ANALOG OUT** 24 jacks, as well as from the **DIGITAL COAXIAL OUT** jack 25 and **DIGITAL OPTICAL OUT** connector 26 simultaneously.

If the **ANALOG IN** jacks 23 are connected, it is possible to select a “mix mode”, where the **ANALOG IN** signals are mixed with the digital audio signals at either the **COAXIAL** or **OPTICAL** input. The digital audio signal is attenuated (cut) by 12 dB when this mix takes place.

2.5 Timer operations

The unit can use its internal clock to start and stop playback or recording at pre-determined times.

2.5.1 Setting the clock

- 1 **When the unit must be in standby mode (power connected but not turned on), and if the time has not been set, the display shows Clock Adjust in dimmed characters.**
- 2 **Press the MENU key (9 or 7). The display lights, and shows CLOCK ADJ ?.**
- 3 **Press the MULTI JOG control (11) or the ENTER key on the remote control unit (8). The “hours” value will start flashing.**
- 4 **Turn the MULTI JOG control or use the remote control unit SKIP keys (18) to set the current hour.**

2 • Features of the CD-RW700—Timer operations

- 5 Press the **MULTI JOG** control or the **ENTER** key to confirm the hour setting. The “minutes” value starts flashing.

NOTE

The unit uses the 24 hour “military” clock, where 1 p.m. is represented by 13, etc.

- 6 Turn the **MULTI JOG** control or use the remote control unit **SKIP** keys to set the current minutes.
- 7 Press the **MULTI JOG** control or the **ENTER** key to confirm the minute setting and return to the standby mode. The unit now shows the current time in standby mode and the colon **:** between the hours and the minutes flash once per second.

NOTE

If the unit is disconnected from the power supply for an extended period of time, the clock must be reset (the **Clock Adjust** message appears when power is reapplied). For this reason, if connecting the unit through a power distributor, we suggest that you use an unswitched outlet on the distributor.

2.5.2 Setting the timer

Once the clock has been set following the procedure above, the timer can be set.

The procedure below sets the time at which the unit will turn on and off.

- 1 Make sure the unit is turned on and a disc is inserted.
- 2 Press the **MENU** key (9) or (7) until the display shows **TIMER ?**.
- 3 Press the **MULTI JOG** control (11) or the **ENTER** key on the remote control unit (8).
- 4 Turn the **MULTI JOG** control or use the remote control unit **SKIP** keys (13) to set the timer hour.

NOTE

The unit uses the 24 hour “military” clock, where 1 p.m. is represented by 13, etc.

- 5 Press the **MULTI JOG** control or the **ENTER** key to confirm the hour setting. The “minutes” value starts flashing.
- 6 Turn the **MULTI JOG** control or use the remote control unit **SKIP** keys to set the timer minutes.
- 7 Press the **MULTI JOG** control or the **ENTER** key to confirm the minutes setting.

- 8 After step 7 above, the display shows **OFF 0:00**.

- 9 Repeat steps 4 through 7 above to set the hours and minutes value.

If the **TIMER** switch (12) is set to **REC** or **PLAY**, the display shows a small “clock” icon, to show that the unit is in timer mode.

2.5.3 Using the timer

When the start time has been set, slide the **TIMER** switch (12) to either the **PLAY** or **REC** position, depending on whether playback or recording is to start at the specified time.

The display shows a small clock icon to show the unit is in timer mode, in standby mode as well as in power-on mode. When the switch is set to **REC**, and a recordable disc is loaded, the **REC** indicator shows beside the clock icon.

When the unit is in standby mode and timer playback is selected, the unit will turn on and start playing at the specified time.

If recording is selected, the unit will turn itself on one minute before recording is due to start. Recording will start at the specified time at the first free location on the disc.

If the off time is set to a time greater than the length of the disc, and playback is selected, the unit will start playing at the start of the disc, and continue to the end.

If timer recording is selected, and the off time is set to a time which is greater than the remaining time on the disc, the unit will continue recording until there is no space left on the disc.

If the timer is set, and the unit is switched on at the timer start time, the timer operation will have no effect.

If the unit has been disconnected from the power supply so that the clock time has been lost, and the timer switch is set, the clock icon will flash rapidly in standby mode as an indication that the current timer setting is invalid.

NOTE

If the unit has recognized the current disc as non-recordable, **Timer Error!** appears when the timer switch is set to **REC**. If the timer is set with the switch at **OFF** or **PLAY** and a non-recordable disc loaded, the unit is then placed in standby, and the switch then set to the **REC** position, this error message will not appear (of course, recording will not take place under these conditions).

The CD-RW700 can be used to play back CDs (including CD-R and CD-RW discs that have been recorded and finalized on other types of recorder), as well as CD-R discs and CD-RW discs that have been recorded on the unit.

3.1 Simple playback operations

- 1 Press the **OPEN/CLOSE** key (③ or ②) to open the disc tray.
- 2 Discs should be inserted in the tray with the label uppermost.
- 3 Press the **OPEN/CLOSE** key (③ or ②) to close the tray again.

When a disc is loaded into the unit, the display briefly shows **TOC Reading.**, with a flashing period following the word “Reading” as the unit determines the contents of the disc. When the TOC has been read, the display shows (at the top left of the display) one of the following:

CD	A commercial pre-recorded CD or a finalized CD-R
CD-R, NO TOC	A CD-R which has yet to be finalized
CD-RW, NO TOC	A CD-RW which has yet to be finalized
CD-RW	A finalized CD-RW (this differs from a CD, as it may be unfinalized and erased)
[blank]	Unusable or unreadable disc or no disc

- 1 Press the **PLAY** key (ⓑ or ④) to start playback
- 2 Press the **STOP** key (ⓑ or ⑤) to stop playback
- 3 Press the **PAUSE** key (ⓑ or ⑥) to pause playback temporarily.

The track number indicators at the bottom of the display light, to show the available unplayed tracks. If there are thirteen tracks on the disc, for example, indicators 1 through 13 will light. If there are more than 20 tracks on a disc, the track number **OVER** indicator (at the bottom of the display) will light.

3.1.1 Time display modes

When playing back a CD (or in pause mode), there are four different time display modes.

In each mode, the current track number is given, followed by the time, as given below, e.g.

10Tr 0:48

Press the **DISPLAY** key (ⓑ or ⑥) to cycle through these time display modes, as described below:

Display shows	Meaning
TOTAL	Total elapsed time of the disc
[blank]	Elapsed time of the current track
TOTAL REMAIN	Time remaining of the current disc
REMAIN	Time remaining of the current track

NOTE

If programmed playback has been selected (3.2, “Programmed order playback”), the elapsed time and total remaining time refer to the programmed material, not the whole disc.

3.1.2 Track search

Use the **MULTI JOG** control (ⓑ) or the **SKIP** keys on the remote control unit (ⓑ) to jump forward or backward by one track at a time, as shown on the display.

Note that going forward from the last track of the disc will “wrap round” to track 1, and going backward from the first track of the disc will “wrap round” to the last track of the disc.

The track number indicators at the bottom of the display shows the selected track (the lit indicator at the left of the row of indicators).

It is also possible to use the number keys on the remote control unit (③) to jump directly to a particular track:

- 1 To play tracks 1 through 9, simply press the appropriate key (1 through 9).
- 2 To play a track whose number is higher than 9, press the **+10** key an appropriate number of times to set the “tens” digit of the track number, followed by a single key to set the “units” digit. For example:

Track 13 = +10, 3

Track 30 = +10, +10, +10, 0

*On the remote control unit only, the **SEARCH** keys (ⓑ) can be used to “fast-forward” and “fast-rewind” through the disc.*

3.1.3 Playback modes

The unit can be set to play back a single track, the whole disc in the order in which it was created, the tracks of the disc in a random (shuffled) order, or a programmed order (see 3.2, “Programmed order playback”).

3 • Playback operations—Programmed order playback

NOTE

Selecting the playback mode is only possible using the remote control unit. It is not possible to select the playback mode using the main unit alone.

1 Press the PLAY MODE key (1) repeatedly to cycle the display through the following:

- **Program** (see 3.2, “Programmed order playback” below). The red PROGRAM display indicator lights in this mode.
- **Shuffle** (random track order). In this mode, each track is played once before the disc repeats. Using the track search functions will move backwards or forwards through the random order, e.g. if track 7 is followed by track 10, it is possible to use the track search keys to go back to track 7, which is remembered as being before immediately before track 10. The red SHUFFLE display indicator lights in this mode.
- **Continue**. Normal playback mode. Programming is cancelled, and playback continues in the normal order.

The selected mode is shown in large characters disappears from the display a few seconds after selecting the mode, and the display returns to its previous mode.

3.2 Programmed order playback

The steps to set up to 25 program steps (tracks) to be played back in a specified order are as follows:

1 Press the PLAY MODE key (1) until the display shows Program.

2 The display changes to show
0Tr 0:00 00,
meaning that no program steps have yet had tracks assigned to them.

3 Use the number keys to enter a track number (including the +10 key to enter values greater than 9, as described in 3.1.2, “Track search”). There is no need to press ENTER.

The track entered is assigned to the program step, and the display changes, showing the track number, the total time of the program so far, and the step number, e.g.

2Tr14:56 03.

4 The next program step can then be entered.

NOTE

Steps 3 and 4 above can be carried out from the main unit by turning and pushing the MULTI JOG control (11).

5 Repeat steps 3 and 4 above until the program is complete.

6 Press the PLAY key (18 or 21) to start playback at the first program step.

The display shows the track, the current time display, and the program step number.

While in programmed playback mode, using the SKIP keys (16 or the MULTI JOG control (11) moves backwards and forwards in the order set in the program.

Use the PAUSE key (19 or 20) to halt playback temporarily or the STOP key (17 or 19) to stop playback of the program.

If the STOP key is used, when playback is restarted, it starts from the first program step.

Clear the program by pressing PLAY MODE (1) until the display shows Continue. The program is also cleared when the disc tray is opened, and if the STOP key is pressed when playback is stopped in programmed order mode.

The programmed play order is not memorized when power is turned off.

If an attempt is made to enter more than 25 program steps, the message PGM Full ! appears on the display.

3.3 Repeat play

The unit can repeat the whole of the disc (or program) or the current track only.

NOTE

Selecting the repeat mode is only possible using the remote control unit. It is not possible to select the repeat mode using the main unit alone.

1 The unit should be in playback, pause or stop mode.

2 Continue to press the REPEAT key (5) so that the display shows Repeat 1 (the REPEAT 1 indicator lights) to repeat one track, or Repeat ALL (the REPEAT ALL indicator lights) to repeat the whole disc or program.

3 If playback has not started, restart it.

To cancel repeat mode, press the REPEAT key so that the display shows Repeat OFF and the REPEAT indicator goes out.

Before you start recording using the CD-RW700, make sure that you understand the following key points:

- Once you have recorded on a CD-R disc, the data cannot be erased from it.
- You can add tracks to an unfinalized recordable disc. Once finalized, a CD-R disc is “fixed” and behaves in the same way as a pre-recorded disc. Finalized CD-RW discs, however, can be erased, refreshed and re-recorded.

4.1 Input selection

To select the input to be recorded, press the **INPUT SELECT** key on the main unit (6).

Repeated presses of the key cycle through the following options:

Analog In	Analog in
Optical In	Optical digital in
Coaxial In	Coaxial digital in
Opt +Analog	Optical digital and analog, mixed
Coax +Analog	Coaxial digital and analog, mixed

In the case of either the coaxial or optical inputs being selected, either alone, or together with the analog inputs, the boxed DIGITAL indicator shows on the display, and the appropriate indicator: COAXIAL or OPTICAL, lights on the display.

If the analog signal is selected, either alone, or together with either of the digital inputs, the boxed ANALOG indicator lights on the display.

4.1.1 Signal volume

The signals from either of the digital inputs (coaxial or optical) can be mixed with the signals from the analog inputs. The signal path is as follows (this description applies, no matter how many inputs are being mixed):

- The analog signals received at the **ANALOG IN** jacks are controlled with the **REC LEVEL** controls (14).
- Any input analog signals are then mixed with the digital signals received at either the **COAXIAL** or **OPTICAL IN** (25 or 26). If analog and digital sig-

nals are being mixed, the digital signals are attenuated by 12 dB. The level of the analog/digital mix is then controlled using the digital volume menu, as described below.

- 1 Press the **RECORD** key (20 or 14) to place the unit in record ready mode.
- 2 Repeatedly press the **MENU** key (9 or 7) until the display shows **VOLUME XXXdB** where XXX is the current setting.
- 3 Use the **MULTI JOG** control (11) or the **SKIP** keys (13) to adjust the input volume between -60dB and +18dB (relative to the original input level). There is also a ----- setting which represents a complete signal cut.

NOTE

If digital direct is selected, as described below (4.3.4, “Digital direct”), the digital volume is bypassed and the menu item does not appear.

4.1.2 Input monitoring

When the unit is in record ready, or record mode, the input signal is output from the **OUT** jacks (digital and analog), allowing you to hear the input signal.

The meters also show the current signal level.

However, it is only possible to record, or to enter record ready mode, when a recordable disc is inserted. To allow monitoring of the input signal at other times, or when the unit is stopped, use the **MONITOR** key on the remote control unit (10).

The **RECORD** key (20) on the main unit will also enter monitor mode from stop mode when there is no recordable disc in the unit (when there is a recordable disc in the unit, pressing the **RECORD** key enters record ready mode).

The word **MONITOR** appears on the display to show that the output signal is an echo of the input signal(s). The meters show the current input level.

Exit the monitor mode by using the **STOP** key.

4.1.3 Frequency conversion

The sampling frequency for CDs is 44.1 kHz. The CD-RW700 will always record (and play back) CDs at this frequency.

However, if recording through a digital connection (either coaxial or optical) and the source has been recorded at a frequency other than 44.1 kHz, or is being played back at a non-standard speed using a varispeed unit (more than 1% away from the standard), the CD-RW700’s internal frequency converter

4 • Recording—Basic recording

will automatically convert the incoming frequency to 44.1 kHz.

NOTE

If digital direct is selected, as described below (4.3.4, “Digital direct”), the frequency convertor is bypassed. In this case, recording from digitally-connected devices is only possible when the source frequency is 44.1 kHz. If an attempt is made to record from a digitally-connected source at a different frequency, the error message `Not. Fs44.1k!` is displayed.

4.2 Basic recording

NOTE

According to the “Red Book” (the specification for audio CDs), a track cannot be less than four seconds in length, and there can be a maximum of 99 tracks on an audio CD. Bear these limitations in mind when recording.

If you press either the **STOP** or the **PAUSE** key within four seconds of starting recording, the unit will continue recording until four seconds have elapsed (since the start of recording) and then stop or pause as appropriate.

After selecting the input source(s) (4.1, “Input selection”), it is possible to start recording.

The basic record procedure is as follows:

- 1 **Load a recordable disc into the unit. As the disc is loaded, the display shows `TOC Reading`.**

When the disc has been loaded, the display indicators show **CD-R, NO TOC**, or **CD-RW, NO TOC**, as appropriate.

- 2 **Press the **RECORD** key (Ⓜ or Ⓛ). The unit enters record ready mode, as shown by the **REC** and **PAUSE** indicators on the display. As the unit enters record ready mode, the display shows `Now OPC` (Optimum Power Control), as the unit prepares to record on the disc.**
- 3 **Adjust the level of the source(s), following the guidelines in 4.1.1, “Signal volume”.**

NOTE

The red **OVER** indicators on the meters should never light. Unlike analog equipment, digital audio units produce extremely unpleasant sounds when distorted, and there is no “headroom” after the 0 mark. If recording digitally from a commercially-produced CD, the volume set in the menu should be 0 dB. This will maintain all the dynamic range of the source CD without clipping. Only boost the signal if the source is exceptionally quiet.

An analog signal input at nominal level, with no cut or boost from the volume controls, is equivalent to a reading of -16 dB on the meters (on other words, 0 is equivalent to 16 dBFS).

- 4 **Press the **PLAY** key (Ⓢ or Ⓜ) or the **PAUSE** key (Ⓛ or Ⓛ) to start recording.**

Note that there is no need to “cue up” the recording position—the unit always finds the next available location on the disc and start recording to it.

- 5 **Press the **PAUSE** key (Ⓛ or Ⓛ) to pause recording temporarily. The pause indicator on the display shows this.**

Pressing **PAUSE** or **PLAY** again restarts recording with a new track number.

- 6 **Press **STOP** (Ⓛ or Ⓛ) to stop recording. When recording stops, the display shows `PMA Writing` (Program Memory Area) and the **REC** indicator flashes for a few seconds as the unit writes to the disc.**

NOTE

While the “PMA Writing” message is displayed, all keys are disabled, and the unit is actually writing to disc. Do not disconnect the power or subject the unit to severe vibration or shocks at this time, as this will prevent proper recording of the information.

When this message disappears, you must press the **RECORD** key (step 2) before restarting the recording. Recording restarts with a new track number.

NOTE

Remember that every time recording is paused or stopped, when recording is restarted, a new track will always be started. It is not possible to record in two “stages” within one track.

4.2.1 Playing back tracks

Although an unfinalized disc cannot be played back on an ordinary CD player, the CD-RW700 can play back tracks that have been recorded.

Use the **MULTI JOG** control (Ⓛ) or the **SKIP** keys (Ⓢ) to select a track for playback.

4.2.2 Time display while recording

While a recordable disc is being played back, the four time display modes available in normal playback as described in 3.1.1, “Time display modes”: **TOTAL**, **TOTAL REMAIN**, **track REMAIN** and **elapsed track time**.

However, during recording there are fewer options available (obviously, the unit cannot see into the future and know how much time remains of the track which is being currently recorded!).

When in record or record ready mode, repeated presses of the **DISPLAY** key (⓫ or Ⓜ) cycle between displaying the remaining time left for recording on the disc (TOTAL REMAIN) and the elapsed time of the track currently being recorded (no indicator lit).

When playback is stopped at the start of a recordable disc, there are only two options available: TOTAL (the total time recorded so far on the disc) and TOTAL REMAIN (the total time available on the disc for further recording).

4.2.3 Manual track division

It is possible to divide the recording into tracks “on the fly” while recording.

While recording is taking place, press the **RECORD** key (Ⓜ or ⓫). The current track number is incremented by one.

For details of automatic track division while recording, see 4.3.2, “Automatic track division”.

NOTE

According to the “Red Book” (the specification for audio CDs), a track cannot be less than four seconds in length, and there can be a maximum of 99 tracks on an audio CD. Bear these limitations in mind when adding track divisions.

4.2.4 Restricting the number of tracks

When making a recording using the CD-RW700, it is possible to restrict the number of tracks that may be recorded at one time. This applies whether the tracks are being divided manually, as described above (4.2.3, “Manual track division”) or being divided automatically (4.3.2, “Automatic track division”).

At any time within record or record ready mode, turn the **MULTI JOG** control (⓫) or use the **SKIP** keys (Ⓜ).

This sets the number of remaining tracks, as shown to the right of the time display. The maximum number here is limited by the standard limit of 99 tracks, and the number of tracks currently recorded. In other words, if 8 tracks have already been recorded on the disc, the maximum value that can be set here is 91 (91+8=99). If 49 tracks have already been recorded on the disc, the maximum value that can be set here is 50 (49+50=99).

Every time a track division is made, the number shown at the right of the display goes down by one. When the number shown is 1, and a track division is made, the display shows **PMA Writing** and the unit enters stop mode.

The number of remaining tracks can be changed during recording using the **MULTI JOG** control.

4.2.5 Full disc

If recording a long program, and the number of tracks has not been restricted, when there is no space remaining on the disc for recording, as shown by the time display (see 4.2.2, “Time display while recording”), just before the end of the disc is reached, the unit starts a fade-out over a few seconds (the display shows **FADE OUT**).

When the fade-out has finished, the display shows **Disc Full!!!** for a few seconds, and the unit then goes into stop mode (the display shows **PMA Writing**).

If the disc is a CD-RW, the final track can be erased, if required (see 5.2.1, “Erasing tracks”) and the disc then finalized. If the disc is a CD-R, it must be finalized prior to use (see 5.1, “Finalizing”).

4.3 Advanced recording

These sections cover more advanced recording techniques.

4.3.1 Synchronized recording

Synchronized recording means that recording will begin automatically when a signal is received, and will stop when the signal ends.

To enable or disable synchronized recording:

- 1 **A recordable disc must be loaded.**
- 2 **With the unit in record ready or record mode, press the SYNC REC key (Ⓜ or ⓫).**

The display shows SYNC ON briefly, and then changes to the track and time display. When synchronized recording is enabled, the SYNC indicator lights in the display.

The SYNC REC key is also used to turn off synchronized recording (the display briefly shows SYNC OFF and then returns to the track and time display).

The signal level which may be used with synchronized recording operations (here called the “trigger level” or “threshold”) is set as below:

4 • Recording—Advanced recording

1 With a recordable disc loaded, press the **MENU** key (9 or 7) until the display shows: **S_LVL>> xxdB**, where **xx** is the current value.

2 Turn the **MULTI JOG** control (11) or use the **SKIP** keys (18) to change the value between **-24, -30, -36, -42, -48, -54, -60, -66, and -72 dB**.

Low numerical values of this setting (towards **-24**) mean that it takes a louder signal to trigger the start of the synchronized recording. A high numerical value (towards **-72**) means that a relatively quiet signal will trigger the start of recording.

The conditions under which an input signal is used as the trigger to start recording are:

- when recording digitally, a digital start signal is detected, and audio is subsequently detected

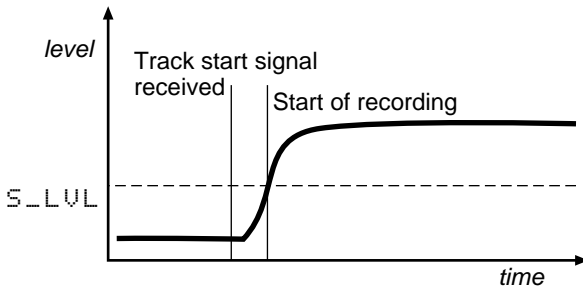

or

- the sound level rises above the threshold (see below) after having been below the threshold for one second or more. Note that the diagram below represents a special case (the source is stopped or paused) of the more general condition, as explained later:

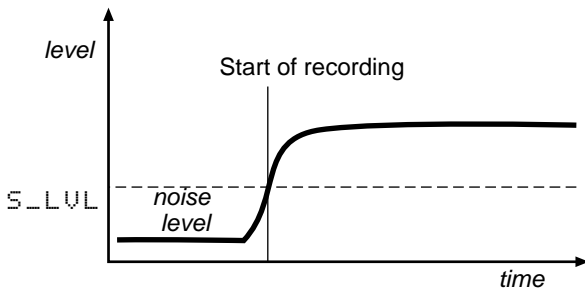

To start synchronized recording when the source is stopped or in pause mode:

- 1** The unit must be in record ready mode, and the **SYNC** indicator in the display must be lit, as explained above.
- 2** Start playing the source. The pause indicator disappears from the display, and the unit starts recording.

The conditions under which synchronized recording stops are:

- when recording digitally, an appropriate digital signal is detected. If the signal is detected from a **CD**, the unit enters record ready mode after 2 seconds. If the signal is detected from an **MD**, the unit enters record ready mode immediately:

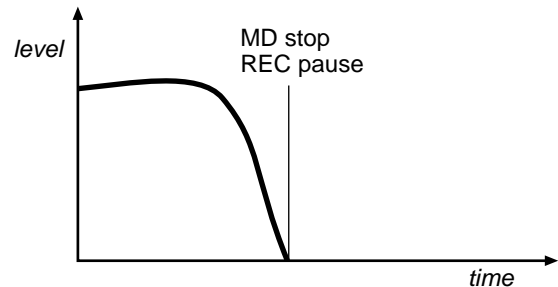
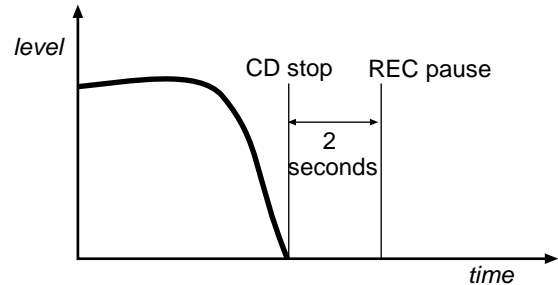

Note that the trigger level is not used here.

or

- the sound level drops below the threshold level for five seconds

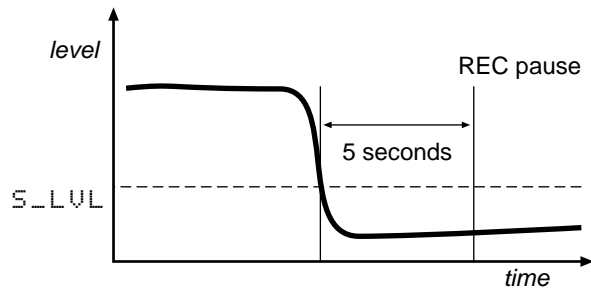

If you set the threshold value so that only high-level signals trigger recording, remember that this will not record the start of a piece with a slow fade-in:

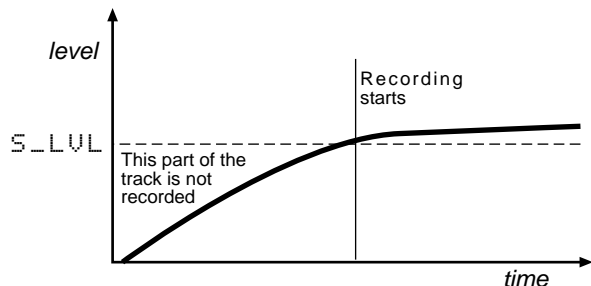

Also remember that when recording from an analog source, the threshold should be set so that it is higher than the “noise floor” (the base level of hiss, pops

4 • Recording—Advanced recording

and crackles which may come from an older vinyl recording, for example). If the “noise floor” is higher than the threshold, synchronized recording will not take place (the rehearsal facility can be used here (4.4, “Rehearsal”) to help):

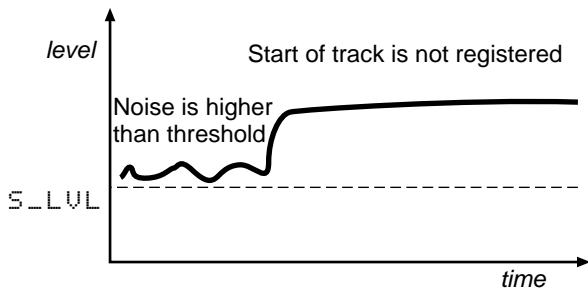

Because synchronized recording can be turned on and off while recording is taking place, it is therefore possible to record with a synchronized automatic start, and a manual end, or *vice versa*.

When the source material is being played back before synchronized recording is enabled, the conditions under which synchronized recording will start (after synchronized recording has been enabled) are:

When the signal drops below the threshold for one second or more and then rises above the threshold again (this is the general condition, of which starting synchronized recording from a stopped or paused source is a special case):

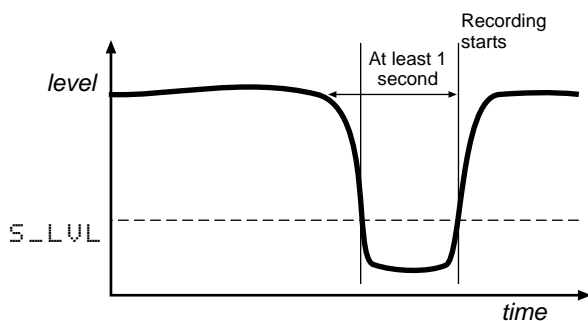

Alternatively, when recording digitally from sources (MD, CD and DAT) which output track divisions, synchronized recording starts when a track division is received, regardless of the level:

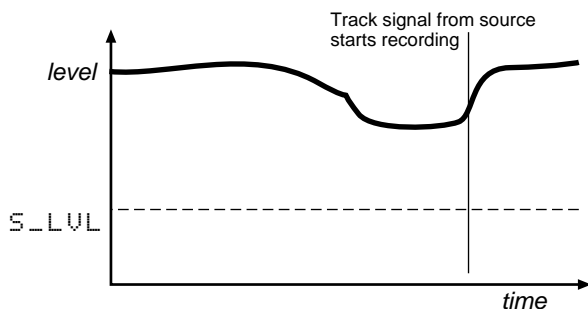

To stop synchronized recording:

- 1 The unit must be in record mode, and the SYNC indicator in the display must be lit.**
- 2 Stop the source. After a few seconds, the unit enters record ready mode. The time between the stopping of the source and entering record ready mode is used to record a gap at the end of the track.**
- 3 If no changes are made to the unit's controls, restarting the source restarts recording, as the unit is still in sync mode and will start recording again when the source is detected.**

NOTE

When recording in sync mode, you may notice a slight delay between starting the source, and the CD-RW700 responding. This is due to the way in which the unit works, storing the data in a memory buffer before writing it to the disc. The resulting delay is therefore not a cause for concern—all audio data received between the start and end points will be recorded.

4.3.2 Automatic track division

The trigger level, as set above (4.3.1, “Synchronized recording”) can also be used to divide tracks if the A-TRACK (auto track) function is enabled.

When this function is enabled, the unit automatically inserts a track division in the recorded material when:

- recording digitally from MD, CD or DAT, an increment signal is detected and the sound level rises above the threshold:

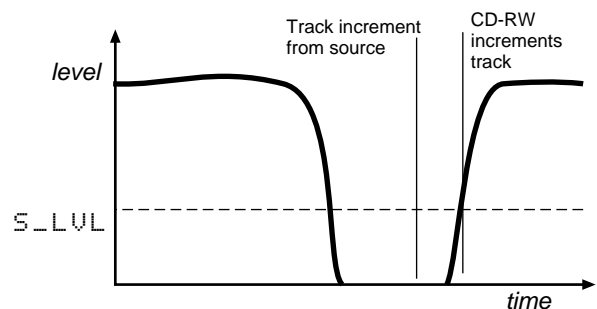

or

- increment signals are unavailable (e.g. analog recording or digital sources other than MD, CD or DAT) and the sound level has dropped below the

4 • Recording—Advanced recording

threshold for more than two seconds, and sound has re-started

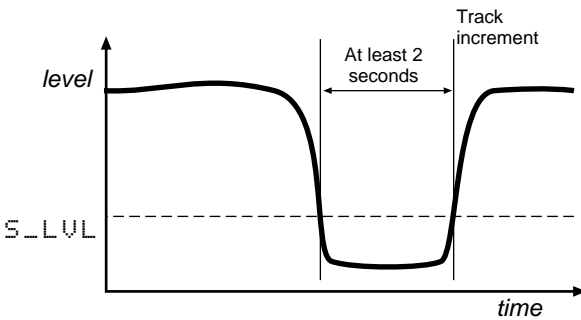

To enable or disable automatic track division:

- 1 With a recordable disc inserted, and with the unit in record ready mode, press the **MENU** key (9 or 7) repeatedly until **A_TRACK > XX** is shown, where **XX** may be **ON** or **OFF**.
- 2 Turn the **MULTI JOG** control (11) or use the **SKIP** keys (18) to change the value to **ON** or **OFF**.

The **A-TRACK** indicator at the top right of the display lights when the auto track function is enabled.

Automatic track division can be turned on or off while recording is taking place.

NOTE

When recording certain types of material (e.g. certain types of classical music or spoken word) through the analog connections, since the track divisions are determined by relative silence, it is possible that spurious track divisions will be inserted. Under these conditions, it may be better to use manual track division (4.2.3, "Manual track division").

However, if recording through a digital connection, the track number will be incremented only when a track division signal is received, followed by a rise in volume.

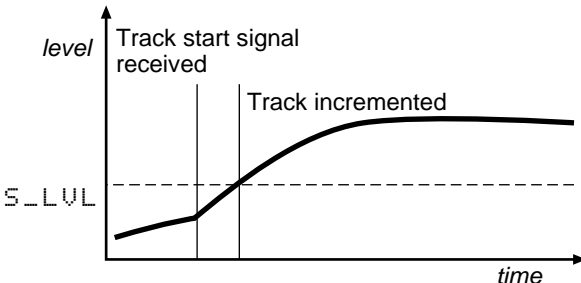

A fall and subsequent rise in volume alone when recording digitally from CD, MD or DAT is not sufficient to trigger an

automatic track increment.

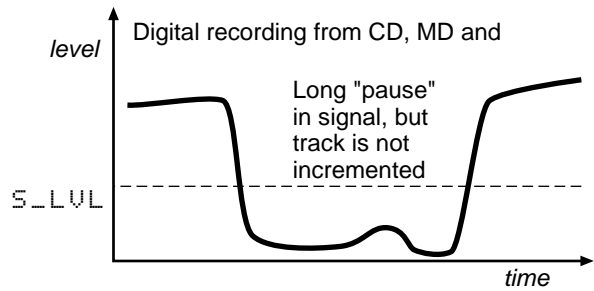

You may find it helpful to use the track restriction facility (see 4.2.4, "Restricting the number of tracks") together with the automatic track division.

For instance, if you have recorded two albums on one DAT tape, and you wish to make two separate CDs from this tape, you can use the **MULTI JOG** control to set the number of tracks to the number of tracks comprising the first album.

When the final track of the first album has been recorded, the unit automatically performs the PMA writing procedure and enters stop mode.

4.3.4 Digital direct

As mentioned earlier, the digital direct mode bypasses some of the input circuitry of the CD-RW700 (the frequency convertor and the digital level control) to write directly to the disc.

To enable or disable digital direct recording:

- 1 Ensure that the input source is set to **DIGITAL** (either **COAXIAL** or **OPTICAL**).
- 2 Press the **DIGITAL DIRECT** key (5) (main unit only). The display shows **D_Direct XX** where **XX** is **ON** or **OFF**.

- 3** Press the **DIGITAL DIRECT** key to toggle between **ON** and **OFF**.

When digital direct recording is enabled, the **DIGITAL** indicator in the display flashes slowly.

NOTE

As mentioned earlier, the digital direct feature bypasses the frequency convertor. Recording is therefore only possible from sources recorded with 44.1 kHz sampling frequency.

4.3.5 Rec mute function

The rec mute function allows instant cut-off of the input signal, and records four seconds of silence on the disc.

- 1** While recording is in progress, press the **REC MUTE** key (16).

The display shows **REC MUTE**, the meters stop displaying the current level and the monitored sound is cut.

- 2** After about four seconds, the unit enters record ready mode.

NOTE

This function is only available from the remote control unit. It is not possible to use this function with the main unit only.

4.3.6 Fade-in and fade-out

To provide smooth beginnings and endings to recorded tracks, the unit provides fade facilities.

Fade-ins are from $-\infty$ (silence) to the set input level (4.1.1, “Signal volume”) and fade-outs go from the current input volume to silence.

The fade-in and fade-out times can be set independently in increments of one second, from 1 second to 24 seconds.

To set the fade times:

- 1** Press the **MENU** key (9) or (7) repeatedly until the display shows **FADE IN > XXS**, where **XX** is the current fade-in time, in seconds.
- 2** Turn the **MULTI JOG** control (11) or use the **SKIP** keys (18) to change the value of the fade-in time.
- 3** Press the **MENU** key again so that the display shows **FADE OUT > XXS**, where **XX** is the current fade-out time, in seconds.
- 4** Turn the **MULTI JOG** control or use the **SKIP** keys to change the value of the fade-out time.

It is possible to set the fade-in time only (perform step 5 after step 2) or the fade-out time only (in step 1, press the **MENU** key until the fade-out time menu item is shown).

To perform the fade-in:

- 1** With a recordable disc loaded, press the **RECORD** key (20 or 14) so that the unit enters record ready mode.
- 2** Start the source material, and press the **FADER** key (22 or 9).

The display shows **FADE IN** for the time specified in the menu item above.

As the fade progresses, the monitored signal gradually becomes louder, reflecting the level recorded on disc.

To perform a fade-out:

- 1** While recording, press the **FADER** key (22 or 9).

The display shows **FADE OUT** for the time specified in the menu above.

As the fade progresses, the monitored signal gradually becomes quieter, reflecting the level recorded on disc.

- 2** When the end of the fade-out time is reached, the unit goes into record ready mode. Recording can be restarted with the **FADER** key or the **PLAY** or **PAUSE** keys.

The fade-in and fade-out times can be reset to new values while recording is in progress.

Fades are also possible in digital direct mode (4.3.4, “Digital direct”).

4.4 Rehearsal

There are two areas in which the unit’s rehearsal facilities can be used: synchronized recording (4.3.1, “Synchronized recording”) and automatic track division (4.3.2, “Automatic track division”).

The purpose of the rehearsal facilities is to allow you to override the automatic synchronized recording and track division facilities where necessary.

Here is an example where this facility may be of value:

A piece has been recorded on DAT, with a verbal count-in immediately prior to the first drum beat. This count-in is not to be recorded as a part of the CD track, but the threshold level has been set to a

4 • Recording—Rehearsal

level where the fourth count will trigger recording (–24 dB — this is the limit of the threshold sensitivity and cannot be adjusted further).

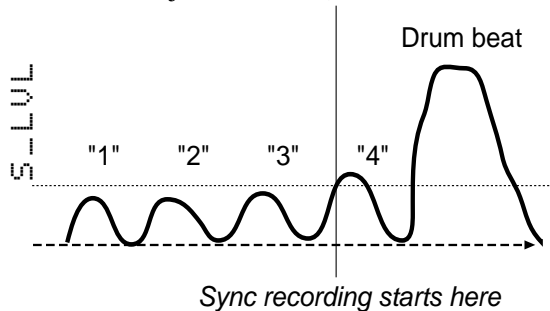

When the rehearsal facility is used, the source is cued up and played, and the first few seconds of the track are sampled and looped. The position of the loop can be adjusted.

This section is looped. The **MULTI JOG** control adjusts the position of the loop

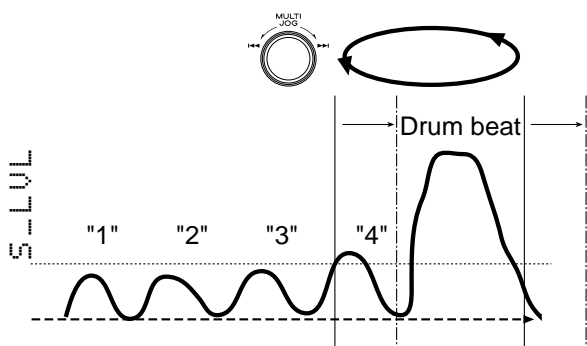

When this offset has been set, synchronized recording takes place with the start occurring at the new location:

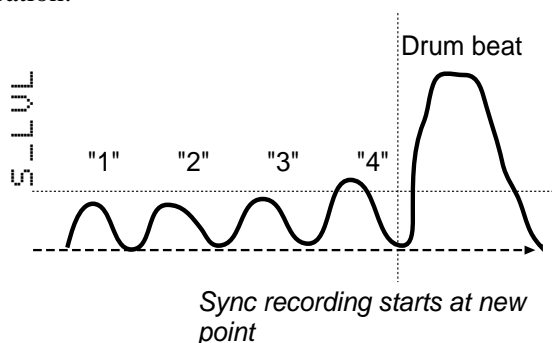

This example shows how the start time can be moved forward, in order to eliminate unwanted “false starts”. It is also possible to “slip” the start time backwards, in order to record a quiet passage that would otherwise not trigger the sync recording facility (this is done by the use of a memory buffer).

As well as being used for changing the start time of synchronized recording, the start of an automatic track division can also be trimmed backwards and forwards in a similar way.

Both the sync start trim and the track start trim can take the same value and can be used in the same recording.

The maximum trim value is 125 frames on either side of the original point (represented by 0), where there are 75 frames in a second (i.e. 1.67 seconds).

4.4.1 Rehearsal for synchronized recording

To perform a synchronized recording, using the rehearsal mode to slip the start of the track forwards or backwards:

- 1 Load a recordable disc into the unit and make sure the unit is in stop mode.
- 2 Cue the source material to the start of the source track to be recorded (i.e. in the example above, this would be just before the count-in).
- 3 Press the RHSL key (4) so that the display shows `Waiting Sync`.
- 4 Start playing the source. When the start of the track is detected (as explained in 4.3.1, “Synchronized recording”), the display changes to `Sync RHSL`.
- 5 If the rehearsal does not start at the region of the true start point, press the RHSL key once again to “re-arm” the trigger.
- 6 After nine seconds, the message changes from `Sync RHSL`, and the sampled data loops in a four-second loop. The display shows `Sync 0:0X`, where X is the current second of the loop.
- 7 Stop the source.
- 8 Turn the MULTI JOG control (11) to adjust the point of the loop. The display shows:
`TRIM = +XXXXf` or
`TRIM = -XXXXf`, where XXX can be a number between 0 and 125 and changes back to the `Sync 0:0X` display when the loop restarts.
- 9 Every time the trim value is changed, the loop starts replaying from the new start point.
- 9 When the new start point has been set, press the STOP key (17) or (19).
- 10 Cue up the source material to the original point set in step 2.
- 11 Press the RECORD key (20) or (14) to enter record ready mode, and then press the SYNC REC key (21) or (15).

12 Start playing the source material. The unit starts recording, with the start point being determined by the trim value.

NOTE

If a trim setting is made for the sync start, this will apply to all sync starts and track divisions made in the future until the value is reset using the procedure above.

4.4.2 Rehearsal for track division

In the same way that the automatic threshold may produce a false trigger, starting recording at the wrong point, the automatic threshold may produce false track divisions.

By rehearsing the point at which the track division is to be made, it is possible to trim the division point so that it corresponds to a the track division which is actually required.

- 1 Load a recordable disc into the unit and make sure the unit is in stop mode.**
- 2 If the unit is not already in auto track mode, set it so that the A-TRACK indicator is lit on the display (4.3.2, “Automatic track division”).**
- 3 Cue the source material to a little before the point of the planned track division.**
- 4 Press the RHSL key (4) twice so that the display shows `Waiting Inc.`**

If the auto track mode has not previously been selected, the display shows `No Inc Mode` when the key is pressed.
- 5 Start playing the source. When the start of the track is detected (as explained in 4.3.1, “Synchronized recording”), the display changes to `Inc RHSL`.**
- 6 If the rehearsal does not start at the region of the true track division point, press the RHSL key once again to “re-arm” the trigger.**
- 7 After nine seconds, the message changes from `Inc RHSL`, and the sampled data loops in**

a four-second loop. The display shows `Inc 0:0X`, where X is the current second of the loop.

- 8 Stop the source.**
- 9 Turn the MULTI JOG control (11) to adjust the point of the loop. The display shows:
`TRIM = +XXXXf` or
`TRIM = -XXXXf`, where XXXX can be a number between 0 and 125 and changes back to the `Inc 0:0X` display when the loop restarts.**
- 10 When the track division point has been fixed, press the STOP key (17) or (19).**
- 11 Press the RECORD key (20) or (14) to enter record ready mode. The synchronized recording mode can be used here, and so the SYNC REC key (21) or (15) may be pressed to prepare for synchronized recording.**
- 12 Cue up the source material to the point where recording is to start.**
- 13 Start playing the source material. If sync recording is not being used, start recording on the CD-RW700 (otherwise recording starts automatically).**

When the track division point (plus or minus the trim value set earlier) is reached, the recording will divide into tracks.

Note that if a positive trim value is set (i.e. the start point of the track is “slipped” to a position past the “normal” start), the counter shows a minus value (e.g. `-0.02`) for the period between the “normal” and the actual adjusted start position. This minus value is also displayed when recording starts, if sync recording has been enabled.

NOTE

If a trim setting is made for the track division, this will apply to all track divisions and sync starts made in the future until the value is reset using the procedure above.

5 - After recording

This section deals with the actions taken after recording: finalizing for CD-R and CD-RW discs, and erase operations for CD-RW discs.

Once finalized, CD-R discs are truly final—no more can be recorded on them. By contrast, CD-RW discs can be “unfinalized” using the CD-RW700, i.e. their TOC can be deleted, and if there is space, further material can be recorded on them. Even if the disc is full, tracks can be erased following the unfinalize process, and new material can be recorded.

5.1 Finalizing

As has been explained earlier (1.2, “Finalizing”), in order for a disc to become a standard CD, it must have a Table of Contents (TOC) written to it. This process is known as finalizing.

An unfinalized disc can always be distinguished on the CD-RW700 by the NO TOC indicator under the disc type on the display being lit when the disc is inserted.

To finalize a disc:

- 1 **With the unfinalized (recordable) disc loaded, and the unit in stop mode, press the FINALIZE key (15) or (12).**
The display shows Finalize OK?.
- 2 **If you do not want to proceed with the finalizing process, press any other key (such as the STOP key).**
- 3 **To start the finalizing process, press the MULTI JOG control (11) or press the ENTER key (8).**
- 4 **If finalization has been chosen, the display changes. The NO TOC indicator goes out, and the word TOC and the REC indicator flashes in the display. The unit starts counting down from a time shown on the display (about 1 minute 10 seconds).**
- 5 **After finalization, a CD-RW NO TOC changes to CD-RW and a CD-R NO TOC changes to a CD.**

NOTE

Although CD-R discs finalized on the CD-RW700 may be replayed on ordinary CD players, remember that finalized CD-RW discs may not play on CD players.

5.1.1 Unfinalizing CD-RW discs

If a CD-RW disc has been finalized, it is possible to erase the Table of Contents in the following way:

- 1 **With the finalized disc loaded and the unit in stop mode, press the ERASE key (16) or (13).**
- 2 **If the display does not show the word Unfinalize?, turn the MULTI JOG control (11) or use the SKIP keys (18) until it is displayed.**
- 3 **If you do not want to proceed with the unfinalizing process, press any other key (such as the STOP key).**
- 4 **To start the unfinalizing process, press the MULTI JOG control (11) or press the ENTER key (8).**
- 5 **If unfinalization has been chosen, the NO TOC indicator starts flashing in the display, and the word ERASE also starts flashing. The unit starts counting down from a time shown on the display (depending on the disc and material, this value will be between 50 seconds and 1 minute 30 seconds).**
- 6 **After unfinalization, a CD-RW indicator changes to a CD-RW NO TOC indicator.**

5.2 Erasing

Unfinalizing (described above) is a special case of erasing a disc. It is also possible to erase a track or tracks, starting with the last-recorded track, a whole disc, or to “refresh” a disc.

NOTE

Erase procedures are possible only on a CD-RW disc. Even if a CD-RW disc has been finalized, selecting an erase procedure will automatically unfinalize it prior to erasure. The disc may then have to be re-finalized. Remember that it is not possible to perform any erase procedures on a CD-R disc.

5.2.1 Erasing tracks

It is possible to erase the last recorded track, the last two recorded tracks, the last three recorded tracks, etc. It is not, however, possible to erase tracks in the “middle” of the disc.

- 1 **With the disc loaded, and the unit in stop mode, press the ERASE key (16) or (13).**
- 2 **If the display does not show ERASE XX-XX?, where XX is the number of the last track recorded on the disc, turn the MULTI JOG control (11) or use the SKIP keys (18) until it is displayed.**

- 3 Turn the **MULTI JOG** control or use the **SKIP** keys to change the number of the first track to be erased. The highest value that this number can take is the last track recorded (e.g. if 17 tracks have been recorded on the disc, 17–17 means that the last track only, 17, will be erased). The lowest value that this number can take is 2 (if this number was 1, the whole disc would be erased, as described below).
- 4 If you do not want to proceed with the erase operation, press any other key (such as the **STOP** key).

NOTE

If only one track has been recorded on the disc, only the “erase disc” option (5.2.2, “Erasing a whole disc”) is available.

- 5 When the range of tracks to be erased has been selected, press the **MULTI JOG** control or press the **ENTER** key **ⓑ**.

NOTE

This operation cannot be undone. If you are going to erase a track or tracks, make sure that they are recordings that you really want to erase!

- 6 If the erase operation has been selected, the word **ERASE** flashes on the display, and the timer starts counting down from 0:20 (20 seconds).
- 7 At the end of the countdown period, the word **Complete** appears briefly on the display, and the display returns to the track/time display.

5.2.2 Erasing a whole disc

When you want to erase a whole disc (all the tracks on a disc), follow the procedure below:

- 1 With the disc loaded, and the unit in stop mode, press the **ERASE** key (**ⓐ** or **ⓑ**).
- 2 Turn the **MULTI JOG** control **ⓑ** or use the **SKIP** keys **ⓑ** until the display shows **ERASE DISC?**.
- 3 If you do not want to proceed with the erase operation, press any other key (such as the **STOP** key).
- 4 To erase the contents of the disc, press the **MULTI JOG** control or press the **ENTER** key **ⓑ**.

NOTE

This operation cannot be undone. If you are going to erase a disc, make sure that it contains only recordings that you really want to erase!

- 5 If the erase operation has been selected, the word **ERASE** flashes on the display, and the timer starts counting down a time value shown on the display.
- 6 At the end of the countdown period, the word **Complete** appears briefly on the display, and the display returns to the track/time display.

5.2.3 Refreshing a disc

If a CD-RW disc has been corrupted at any point (e.g. power has been cut off in the middle of a finalize operation, etc.), or has been used in a computer or another piece of equipment that makes it unreadable, it is possible to “refresh” the disc to make it usable again. This is equivalent to formatting a disk on a computer to prepare it for use. This operation destroys all data on the disc.

- 1 With the disc loaded, and the unit in stop mode, press the **ERASE** key (**ⓐ** or **ⓑ**).
- 2 Turn the **MULTI JOG** control **ⓑ** or use the **SKIP** keys **ⓑ** until the display shows **DISC REFRESH**.
- 3 If you do not want to proceed with the refresh operation, press any other key (such as the **STOP** key).
- 4 To refresh the disc, press the **MULTI JOG** control or press the **ENTER** key **ⓑ**.

NOTE

This operation cannot be undone. If you are going to refresh a disc, make sure that it contains only recordings that you really want to erase!

- 5 If the erase operation has been selected, the word **ERASE** flashes on the display, and the timer starts counting down. The refresh operation typically takes around 20 minutes or so.
- 6 At the end of the countdown period, the word **Complete** appears briefly on the display, and the display returns to the track/time display (of course, there are no tracks, and the disc is as the start, with the total time of the disc available for recording).

6 - Reference and specifications

6.1 Troubleshooting

Symptom	Possible cause and remedy
No sound on playback (the disc is playing and the time display is incrementing)	The connections from the CD-RW700 to the amplifier system have not been made properly, or the input source selector is not at the correct position.
No meter indication when a source is input	Analog and/or digital volume (4.1.1, "Signal volume") is set too low. The signal is being input through an unselected input source (4.1, "Input selection")
D-IN UNLOCK!	A digital input source has been selected, but the source is not connected or is not switched on.
Cannot record on a disc (pressing RECORD shows MONITOR)	A finalized disc has been inserted. Use an unfinalized recordable disc.
PGM Full !	An attempt has been made to create more than 25 program steps.
Disc Full! or Cannot Rec!	There is no space on the disc, or no tracks are available, or a general recording error has occurred
SCMS !!	You are trying to record digitally from a "second-generation" digital copy. Try analog recording (4.3.3, "SCMS and the CD-RW700".
Not FS 44.1k!	You are trying to do digital direct recording from a source which has not been recorded at 44.1 kHz (4.3.4, "Digital direct")
No Inc Mode	Auto track is not on when an attempt is being made to rehearse track split times.
Timer Error!	An attempt has been made to set timer recording (2.5.3, "Using the timer") with a non-recordable disc, or no disc.
Disc Error	The disc is bad. If it is a CD-RW disc, you may refresh it (5.2.3, "Refreshing a disc"), otherwise replace the disc.
Erase Error!	An error has occurred while trying to erase the disc
The display suddenly shows PMA Writing	Either the disc is full (this message will be prefaced by Disc Full!! (4.2.5, "Full disc") or an attempt has been made to write more than 99 tracks.
Rec Error	General recording error. This may be caused by vibration or a shock during recording, for example, or may be the result of a bad disc. Try recording again with the same disc. If the message appears again, try a different disc.
No OPC Area!	Appears only with CD-R discs. The OPC area is full, and no further recording is possible on this disc. Finalize the disc.

Symptom	Possible cause and remedy
OPC Area CLR	Seen when a CD-RW disc OPC area is full, and the CD-RW700 automatically cleans up the OPC area for further recording.
Need Repair!, System Err!, Tray Error!, Drive Error!	These messages indicate an internal error in the unit. Consult your dealer or distributor regarding repair facilities.

6.2 Specifications

Recording media type	CD-R, CD-RW
Recording resolution	16-bit linear
Recording sampling frequency	44.1 kHz
Frequency convertor input	32 kHz — 48 kHz
Frequency response	20 Hz — 20 kHz (playback ± 0.5 dB, recording ± 1 dB)
S/N ratio	98 dB (playback) 92 dB (recording)
Dynamic range	94 dB (playback) 92 dB (recording)
Total harmonic distortion	0.004% (playback) 0.005% (recording)
Channel separation	90 dB (playback : 1 kHz) 80 dB (recording : 1 kHz)
Wow & flutter	Unmeasurable (< 0.001%)
Analog inputs	Unbalanced RCA
Nominal input level	-10 dBV (FS -16 dB)
Maximum input level	+ 6dBV
Input impedance	33 k Ω (unbalanced)
Analog outputs	Unbalanced RCA
Nominal output level	-10 dBV (FS -16 dB)
Maximum output level	+6 dBV
Output impedance	800 Ω (unbalanced)
Headphone output	6 mm (1/4") stereo
Output level	35 mW + 35 mW (into 32 Ω)
Digital inputs	
COAXIAL	RCA pin, IEC60958 TYPE II
OPTICAL	TOSLINK , IEC60958 TYPE II
Digital outputs	
COAXIAL	RCA pin, IEC60958 TYPE II
OPTICAL	TOSLINK , IEC60958 TYPE II
Voltage requirements	USA/Canada 120 VAC, 60 Hz U.K./Europe 230 VAC, 50 Hz Australia 240 VAC, 50 Hz General export 120/230 VAC, 60 Hz
Power consumption	27 W
Dimensions w x h x d	483 x 98 x 312 (mm) 19 x 3.9 x 12.3 (in)
Weight	6.3 kg (13.9 lbs)
Operating temperature	5°C to 35°C (41°F to 95°F)
Supplied accessories	RC-RW700 remote control unit 2 x type 3 (AA) batteries