

# TASCAM

TEAC Professional Division

3D0038800A

# CD-RW2000

CD Rewritable Recorder

**Professional**

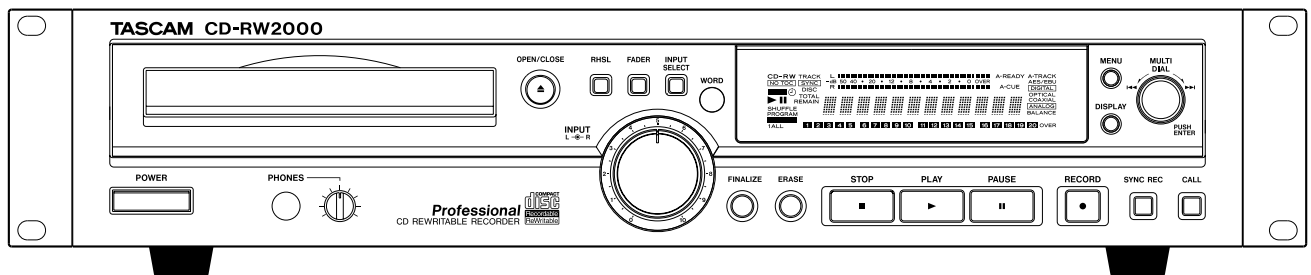

## OWNER'S MANUAL



**CAUTION:** TO REDUCE THE RISK OF ELECTRIC SHOCK, DO NOT REMOVE COVER (OR BACK). NO USER-SERVICEABLE PARTS INSIDE. REFER SERVICING TO QUALIFIED SERVICE PERSONNEL.



The lightning flash with arrowhead symbol, within an equilateral triangle, is intended to alert the user to the presence of uninsulated "dangerous voltage" within the product's enclosure that may be of sufficient magnitude to constitute a risk of electric shock to persons.



The exclamation point within an equilateral triangle is intended to alert the user to the presence of important operating and maintenance (servicing) instructions in the literature accompanying the appliance.

This appliance has a serial number located on the rear panel. Please record the model number and serial number and retain them for your records.  
Model number \_\_\_\_\_  
Serial number \_\_\_\_\_

**WARNING: TO PREVENT FIRE OR SHOCK HAZARD, DO NOT EXPOSE THIS APPLIANCE TO RAIN OR MOISTURE.**

# Important Safety Precautions

## IMPORTANT (for U.K. Customers)

### **DO NOT cut off the mains plug from this equipment.**

If the plug fitted is not suitable for the power points in your home or the cable is too short to reach a power point, then obtain an appropriate safety approved extension lead or consult your dealer.

If nonetheless the mains plug is cut off, remove the fuse and dispose of the plug immediately, to avoid a possible shock hazard by inadvertent connection to the mains supply.

If this product is not provided with a mains plug, or one has to be fitted, then follow the instructions given below:

**IMPORTANT:** The wires in this mains lead are coloured in accordance with the following code:

<b>GREEN-AND-YELLOW</b>	: EARTH
<b>BLUE</b>	: NEUTRAL
<b>BROWN</b>	: LIVE

**WARNING:** This apparatus must be earthed.

As the colours of the wires in the mains lead of this apparatus may not correspond with the coloured markings identifying the terminals in your plug proceed as follows:

The wire which is coloured GREEN-and-YELLOW must be connected to the terminal in the plug which is marked by the letter E or by the safety earth symbol  $\perp$  or coloured GREEN or GREEN-and-YELLOW.

The wire which is coloured BLUE must be connected to the terminal which is marked with the letter N or coloured BLACK.

The wire which is coloured BROWN must be connected to the terminal which is marked with the letter L or coloured RED.

When replacing the fuse only a correctly rated approved type should be used and be sure to re-fit the fuse cover.

IF IN DOUBT — CONSULT A COMPETENT ELECTRICIAN.

For U.S.A

## TO THE USER

This equipment has been tested and found to comply with the limits for a Class A digital device, pursuant to Part 15 of the FCC Rules. These limits are designed to provide reasonable protection against harmful interference when the equipment is operated in a commercial environment. This equipment generates, uses, and can radiate radio frequency energy and, if not installed and used in accordance with the instruction manual, may cause harmful interference to radio communications.

Operation of this equipment in a residential area is likely to cause harmful interference in which case the user will be required to correct the interference at his own expense.

### **CAUTION**

Changes or modifications to this equipment not expressly approved by TEAC CORPORATION for compliance could void the user's authority to operate this equipment.

### **For the consumers in Europe**

#### **WARNING**

This is a Class A product. In a domestic environment, this product may cause radio interference in which case the user may be required to take adequate measures.

### **Pour les utilisateurs en Europe**

#### **AVERTISSEMENT**

Il s'agit d'un produit de Classe A. Dans un environnement domestique, cet appareil peut provoquer des interférences radio, dans ce cas l'utilisateur peut être amené à prendre des mesures appropriées.

### **Für Kunden in Europa**

#### **Warnung**

Dies ist eine Einrichtung, welche die Funk-Entstörung nach Klasse A besitzt. Diese Einrichtung kann im Wohnbereich Funkstörungen verursachen ; in diesem Fall kann vom Betreiber verlangt werden, angemessene Maßnahmen durchzuführen und dafür aufzukommen.

# IMPORTANT SAFETY INSTRUCTIONS

## CAUTION:

- Read all of these Instructions.
- Save these Instructions for later use.
- Follow all Warnings and Instructions marked on the audio equipment.

- 1) Read Instructions** — All the safety and operating instructions should be read before the product is operated.
- 2) Retain Instructions** — The safety and operating instructions should be retained for future reference.
- 3) Heed Warnings** — All warnings on the product and in the operating instructions should be adhered to.
- 4) Follow Instructions** — All operating and use instructions should be followed.
- 5) Cleaning** — Unplug this product from the wall outlet before cleaning. Do not use liquid cleaners or aerosol cleaners. Use a damp cloth for cleaning.
- 6) Attachments** — Do not use attachments not recommended by the product manufacturer as they may cause hazards.
- 7) Water and Moisture** — Do not use this product near water — for example, near a bath tub, wash bowl, kitchen sink, or laundry tub; in a wet basement; or near a swimming pool; and the like.
- 8) Accessories** — Do not place this product on an unstable cart, stand, tripod, bracket, or table. The product may fall, causing serious injury to a child or adult, and serious damage to the product. Use only with a cart, stand, tripod, bracket, or table recommended by the manufacturer, or sold with the product. Any mounting of the product should follow the manufacturer's instructions, and should use a mounting accessory recommended by the manufacturer.
- 9)** A product and cart combination should be moved with care. Quick stops, excessive force, and uneven surfaces may cause the product and cart combination to overturn.



- 10) Ventilation** — Slots and openings in the cabinet are provided for ventilation and to ensure reliable operation of the product and to protect it from overheating, and these openings must not be blocked or covered. The openings should never be blocked by placing the product on a bed, sofa, rug, or other similar surface. This product should not be placed in a built-in installation such as a bookcase or rack unless proper ventilation is provided or the manufacturer's instructions have been adhered to.
- 11) Power Sources** — This product should be operated only from the type of power source indicated on the marking label. If you are not sure of the type of power supply to your home, consult your product dealer or local power company. For products intended to operate from battery power, or other sources, refer to the operating instructions.
- 12) Grounding or Polarization** — This product may be equipped with a polarized alternating-current line plug (a plug having one blade wider than the other). This plug will fit into the power outlet only one way. This is a safety feature. If you are unable to insert the plug fully into the outlet, try reversing the plug. If the plug should still fail to fit, contact your electrician to replace your obsolete outlet. Do not defeat the safety purpose of the polarized plug.
- 13) Power-Cord Protection** — Power-supply cords should be routed so that they are not likely to be walked on or pinched by items placed upon or against them, paying particular attention to cords at plugs, convenience receptacles, and the point where they exit from the product.
- 14) Outdoor Antenna Grounding** — If an outside antenna or cable system is connected to the product, be sure the antenna or cable system is grounded so as to provide some protection against voltage surges and built-up static charges. Article 810 of the National Electrical Code, ANSI/NFPA 70, provides information with regard to proper grounding of the mast and supporting structure, grounding of the lead-in wire to an antenna discharge unit, size of grounding conductors, location of antenna-discharge unit, connection to grounding electrodes, and requirements for the grounding electrode.

## "Note to CATV system installer:

This reminder is provided to call the CATV system installer's attention to Section 820-40 of the NEC which provides guidelines for proper grounding and, in particular, specifies that the cable ground shall be connected to the grounding system of the building, as close to the point of cable entry as practical.

Example of Antenna Grounding as per National Electrical Code, ANSI/NFPA 70

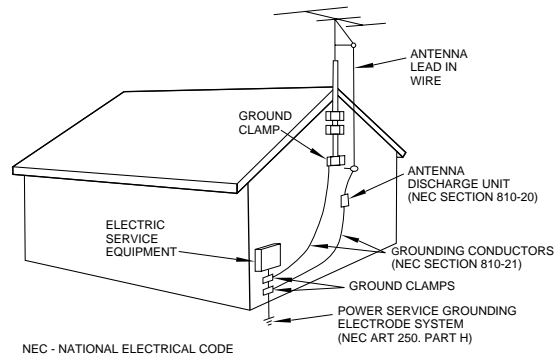

- 15) Lightning** — For added protection for this product during a lightning storm, or when it is left unattended and unused for long periods of time, unplug it from the wall outlet and disconnect the antenna or cable system. This will prevent damage to the product due to lightning and power-line surges.
- 16) Power Lines** — An outside antenna system should not be located in the vicinity of overhead power lines or other electric light or power circuits, or where it can fall into such power lines or circuits. When installing an outside antenna system, extreme care should be taken to keep from touching such power lines or circuits as contact with them might be fatal.
- 17) Overloading** — Do not overload wall outlets, extension cords, or integral convenience receptacles as this can result in risk of fire or electric shock.
- 18) Object and Liquid Entry** — Never push objects of any kind into this product through openings as they may touch dangerous voltage points or short-out parts that could result in a fire or electric shock. Never spill liquid of any kind on the product.
- 19) Servicing** — Do not attempt to service this product yourself as opening or removing covers may expose you to dangerous voltage or other hazards. Refer all servicing to qualified service personnel.
- 20) Damage Requiring Service** — Unplug this product from the wall outlet and refer servicing to qualified service personnel under the following conditions:
  - a) when the power-supply cord or plug is damaged.
  - b) if liquid has been spilled, or objects have fallen into the product.
  - c) if the product has been exposed to rain or water.
  - d) if the product does not operate normally by following the operating instructions. Adjust only those controls that are covered by the operating instructions as an improper adjustment of other controls may result in damage and will often require extensive work by a qualified technician to restore the product to its normal operation.
  - e) if the product has been dropped or damaged in any way.
  - f) when the product exhibits a distinct change in performance — this indicates a need for service.
- 21) Replacement Parts** — When replacement parts are required, be sure the service technician has used replacement parts specified by the manufacturer or have the same characteristics as the original part. Unauthorized substitutions may result in fire, electric shock, or other hazards.
- 22) Safety Check** — Upon completion of any service or repairs to this product, ask the service technician to perform safety checks to determine that the product is in proper operating condition.
- 23) Wall or Ceiling Mounting** — The product should be mounted to a wall or ceiling only as recommended by the manufacturer.
- 24) Heat** — The product should be situated away from heat sources such as radiators, heat registers, stoves, or other products (including amplifiers) that produce heat.

## SAFETY INFORMATION

This product has been designed and manufactured according to FDA regulations "title 21, CFR, chapter 1, subchapter J, based on the Radiation Control for Health and Safety Act of 1968", and is classified as a class 1 laser product. There is no hazardous invisible laser radiation during operation because invisible laser radiation emitted inside of this product is completely confined in the protective housings.

The label required in this regulation is shown in ①.

### CAUTION

- DO NOT REMOVE THE PROTECTIVE HOUSING USING A SCREWDRIVER.
- USE OF CONTROLS OR ADJUSTMENTS OR PERFORMANCE OF PROCEDURES OTHER THAN THOSE SPECIFIED HEREIN MAY RESULT IN HAZARDOUS RADIATION EXPOSURE.
- IF THIS PRODUCT DEVELOPS TROUBLE, CONTACT YOUR NEAREST QUALIFIED SERVICE PERSONNEL, AND DO NOT USE THE PRODUCT IN ITS DAMAGED STATE.

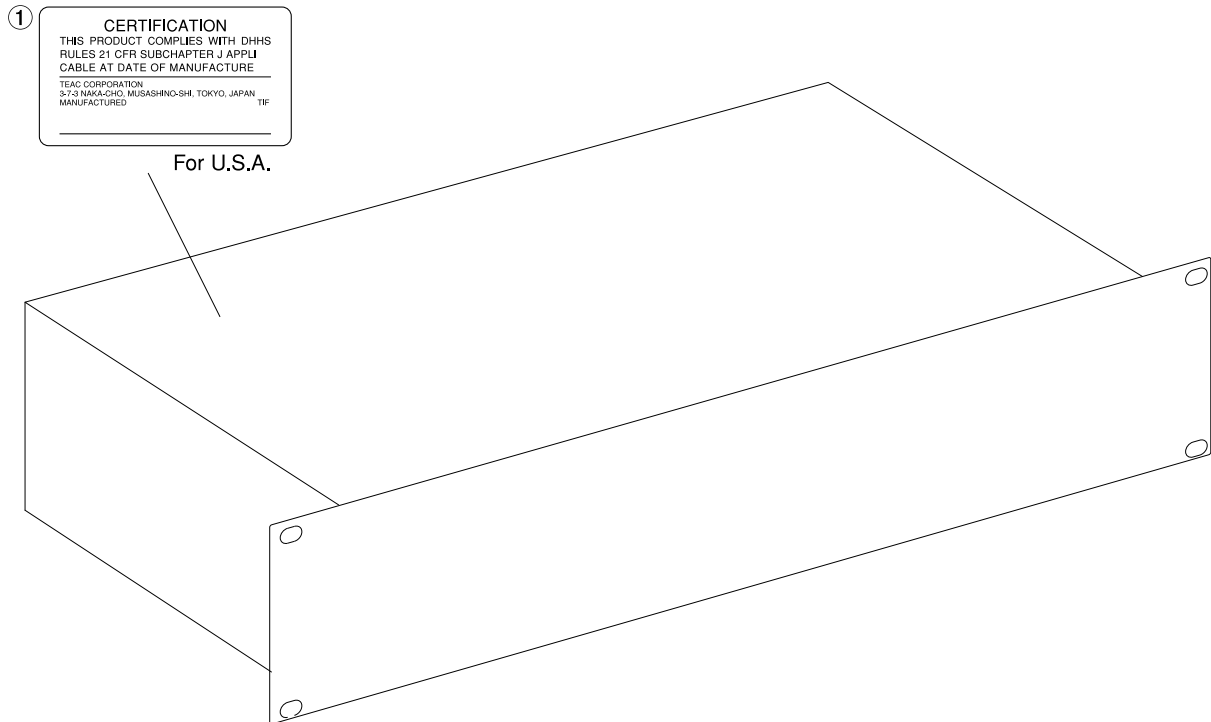

**Optical pickup:** Type : KRS-202A or KRS-220B  
Manufacturer : SONY Corporation  
Laser output : Less than 0.1 mW (Play) and 32 mW  
(Record) on the objective lens  
Wavelength : 777 - 787 nm

## 1 – Introduction

1.1	About CD-R and CD-RW discs	6
1.2	Finalizing	7
1.2.1	“Recordable” discs	7
1.2.2	About this manual	7
1.3	Unpacking the CD-RW2000	7
1.3.1	Rack-mounting the unit	7
1.4	Environmental considerations	7
1.4.1	Beware of condensation	8
1.4.2	Never use a stabilizer or printable discs	8
1.4.3	Handling of compact discs	8
1.4.4	Additional notes with regard to CD-R and CD-RW discs	8
1.4.5	Recommended media	9
1.4.6	Default settings	9
1.4.7	Dimensional drawing	9

## 2 – Features of the CD-RW2000

2.1	Front panel	11
①	POWER switch	11
②	Disc tray	11
③	OPEN/CLOSE key	11
④	RHSL key	11
⑤	FADER key	11
⑥	INPUT SELECT	11
⑦	WORD indicator	11
⑧	Display	11
⑨	MENU key	11
⑩	DISPLAY key	11
⑪	MULTI DIAL control	11
⑫	PHONES jack and LEVEL control	11
⑬	REC LEVEL controls	11
⑭	FINALIZE key	11
⑮	ERASE key	11
⑯	STOP key	11
⑰	PLAY key	12
⑱	PAUSE key	12
⑲	RECORD key	12
⑳	SYNC REC key	12
㉑	CALL key	12
2.2	Rear panel	12
㉒	ANALOG INPUT (L, R) (UNBALANCED)	12
㉓	ANALOG OUTPUT (L, R) (UNBALANCED)	12
㉔	ANALOG INPUT (L, R) (BALANCED)	12
㉕	ATT (attenuation for right balanced analog output)	12
㉖	ANALOG OUTPUT (L, R) (BALANCED)	12
㉗	ATT (attenuation for left balanced analog output)	12
㉘	REMOTE IN (FROM RC-RW2000)	12
㉙	CONTROL I/O	12
㉚	75W switch	12
㉛	WORD SYNC IN	12
㉜	DIGITAL INPUT, OUTPUT (AES/EBU)	12
㉝	DIGITAL COAXIAL (IN, OUT)	12
㉞	DIGITAL OPTICAL (IN, OUT)	12
㉟	~ IN (AC power inlet)	12
2.3	Remote control unit	13
①	OPEN/CLOSE key	13
②	Number keys (0 through 10 and +10)	13
③	CLEAR key	13
④	REPEAT key	13

⑤	DISPLAY key	13
⑥	MENU key	13
⑦	ENTER key	13
⑧	FADER key	13
⑨	MONITOR key	13
⑩	PLAY MODE key	13
⑪	FINALIZE key	13
⑫	ERASE key	13
⑬	RECORD key	13
⑭	SYNC REC key	13
⑮	REC MUTE key	13
⑯	SEARCH keys	13
⑰	SKIP keys	13
⑱	STOP key	13
⑲	PAUSE key	13
㉑	CALL key	13
㉑	PLAY key	13

2.4	Connections	13
2.4.1	Word sync connections	14
2.4.2	Control connections	14

## 3 – Playback operations

3.1	Simple playback operations	15
3.1.1	Time display modes	15
3.1.2	Track search	15
3.1.3	Playback modes	15
3.2	Programmed order playback	16
3.3	Repeat play	16
3.4	CALL playback	17
3.5	Auto Ready function	17
3.6	Auto Cue function	17
3.7	Incremental play	17

## 4 – Recording

4.1	Input selection	18
4.1.1	Signal volume	18
4.1.2	Input monitoring	18
4.1.3	Frequency conversion	18
4.2	Basic recording	19
4.2.1	Playing back tracks	19
4.2.2	Time display while recording	19
4.2.3	Manual track division	20
4.2.4	Restricting the number of tracks	20
4.2.5	Full disc	20
4.3	Advanced recording	20
4.3.1	Synchronized recording	20
4.3.2	Automatic track division	23
4.3.3	Digital direct	24
4.3.4	Rec mute function	24
4.3.5	Fade-in and fade-out	24
4.4	Copy-protection	25
4.5	Rehearsal	25
4.5.1	Rehearsal for synchronized recording	26
4.5.2	Rehearsal for track division	27

## 5 – After recording

5.1	Finalizing	28
5.1.1	Unfinalizing CD-RW discs	28
5.2	Erasing	28
5.2.1	Erasing tracks	28
5.2.2	Erasing a whole disc	29
5.2.3	Refreshing a disc	29

## 6 – Reference and specifications

6.1	Troubleshooting	30
6.2	Specifications	30

# 1 – Introduction

The CD-RW2000 CD rewritable recorder allows you to make your own CDs from a variety of sources—other CDs, MD recordings, analog cassette tapes, and records.

Tracks can be recorded all at one time, or added, until the disc is “finalized”, allowing it to be played on CD players.

## NOTE

*Some models of CD player may be unable to play certain discs produced using the CD-RW2000.*

A variety of sophisticated features are incorporated in the CD-RW2000, allowing a wide degree of flexibility.

The CD-RW2000 provides analog balanced and unbalanced audio inputs and outputs for connection to +4 dBu and –10 dBV equipment respectively.

In addition, AES/EBU, coaxial and optical digital audio inputs and outputs are provided for recording from and playing back to suitably-equipped digital audio equipment.

24-bit digital-to-analog and analog-to-digital converters provide excellent recording and playback quality.

A sampling frequency convertor is incorporated, allowing the recording of CDs from digital audio sources which are at frequencies other than the CD standard sampling frequency of 44.1 Hz.

Track divisions can be entered manually, or can be produced automatically as a response to the input signal level.

A recording buffer ensures that even the first milliseconds of a track are recorded, and a rehearsal mode allows the precise positioning of track divisions, allowing the elimination of false starts or late entries.

“One-touch” fade-ins and fade-outs over a specified time allow you to edit program material to your specific requirements.

A multi-function “multi dial” control is used to set and confirm parameter settings.

A wired remote control unit allows control of the CD-RW2000 from remote locations.

## NOTE

*This product is designed to help you record and reproduce sound works to which you own the copyright, or where you have obtained permission from the copyright holder or the rightful licensor. Unless you own the copyright, or have obtained the appropriate permission from the copyright holder or the right-*

*ful licensor, your unauthorized recording, reproduction or distribution thereof may result in severe criminal penalties under copyright laws and international copyright treaties. If you are uncertain about your rights, contact your legal advisor. Under no circumstances will TEAC Corporation be responsible for the consequences of any illegal copying performed using the CD-RW2000.*

## 1.1 About CD-R and CD-RW discs

The CD-RW2000 uses CD-R and CD-RW media, and can also use CD-R and CD-RW Digital Audio media.

In this manual, when we refer to “CD-R” and “CD-RW” discs, we always include “CD-R Digital Audio” and “CD-RW Digital Audio”, even when this is not explicitly stated.

CD-R discs can be recorded once only. Once they have been used for recording, they cannot be erased or re-recorded. However, if space is available on the disc, additional material can be recorded. The packaging of CD-R discs will include one of the following logos:



By contrast, a CD-RW disc can be used in much the same way as a CD-R disc, but the last track or tracks recorded can be erased before the disc has been “finalized”, and the space on the disc can be re-used for other recordings. The packaging of CD-RW discs will include one of the following logos:

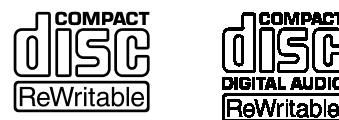

However, you should note that an audio CD created using a CD-RW disc may not play back satisfactorily on every audio CD player. It will, naturally, be playable on the CD-RW2000. This is in no way a limitation of the CD-RW2000 itself, but of the difference between the different types of media and the methods used to read them.

CD-R discs created on the CD-RW2000, by contrast, may be played satisfactorily on the majority of audio CD players.

For details of disc brands that are known to work well with the CD-RW2000, see 1.4.5, “Recommended media”.

## 1.2 Finalizing

Although audio data may be written on a CD-R or CD-RW disc, a standard CD player will not be able to read the data (i.e. play back the audio) until a final table of contents (TOC) has been written at the start of the disc.

The process of writing this table of contents is known as “finalizing”. Once this has been done, no further data can be written to the disk. See 5.1, “Finalizing” for details.

In the case of a CD-RW disc which has been finalized, the whole of the disc may be erased, or the disc may be “refreshed”, and the disc re-used.

In addition, a CD-RW disc that has been finalized may be “unfinalized”, i.e. the TOC is removed. This allows further tracks to be recorded to the disc, provided that there is space on the disc.

### 1.2.1 “Recordable” discs

In this manual, we use the term “recordable” disc to describe a CD-R or CD-RW disc that has not been finalized, i.e. further recording is possible on the disc.

### 1.2.2 About this manual

In this manual, we use the following conventions:

- The names of keys and controls are given in the following typeface: **ERASE**.
- When the alphanumeric portion of the display shows a message, this is shown in the following typeface: `Welc ome`.
- If a preset indicator in the display (i.e. one which cannot change, but is either on or off) is shown, this is shown as follows: SHUFFLE.
- When referring to a front or rear panel control or feature, the following typeface is used to show the number of the feature (as given in the diagram in this manual, and the corresponding explanation): ⑤.
- When referring to a remote control key, the following typeface is used to show the number of the key (as given in the diagram in this manual, and the corresponding explanation): ⑤.

## 1.3 Unpacking the CD-RW2000

When unpacking the unit, you should find the following items, in addition to this manual:

- The main unit itself
- The remote control unit
- Two AA batteries for the remote control unit
- A rack-mounting screw kit

### 1.3.1 Rack-mounting the unit

Use the rack-mounting kit to mount the unit in a standard 19-inch equipment rack, as shown below. Remove the feet of the unit before mounting it.

See 1.4, “Environmental considerations” below for details of ventilation, etc.

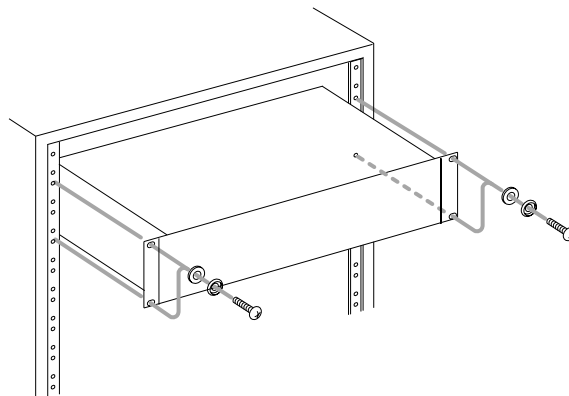

## 1.4 Environmental considerations

The CD-RW2000 may be used in most areas, but to maintain top performance, and prolong operating life, observe the following environmental conditions:

The nominal temperature should be between 5°C and 35°C (41°F and 95°F). The CD-RW2000 is more sensitive to extremes of temperature than ordinary CD players.

Relative humidity should be 30 to 90 degrees non-condensing.

As the unit may become hot during operation, always leave sufficient space above the unit for ventilation. If you are mounting the unit in a rack, leave 1U of space above it.

You should not place the unit on a piece of equipment generating heat, e.g. an amplifier, to avoid possible problems with overheating.

Make sure that the unit is mounted in a level position for correct operation. Do not mount the unit in a rack tilted 5° or more from the vertical position.

### NOTE

*If the mounting surface is more than 5 degrees away from the horizontal, the tray will not open or close.*

# 1 – Introduction—Environmental considerations

The voltage supplied to the unit should match the voltage as printed on the rear panel. If you are in any doubt regarding this matter, consult an electrician.

## NOTE

*When transporting the unit, always use the original packing materials. For this reason, we strongly recommend that you save all the packing materials that came with the CD-RW2000, in case you need to transport it in the future.*

*In addition, when transporting the unit, you should tape the disc tray closed, using an adhesive tape that will not spoil the finish of the unit.*

### 1.4.1 Beware of condensation

If the unit (or a compact disc) is moved from a cold to a warm place, or used after a sudden temperature change, there is a danger of condensation; vapor in the air could condense on the internal mechanism, making correct operation impossible. To prevent this, or if this occurs, leave the player for one or two hours with the power turned on, then turn the power off and on again.

### 1.4.2 Never use a stabilizer or printable discs

Using commercially available CD stabilizers or printable recordable discs with this player will damage the mechanism and cause it to malfunction.

## NOTE

*Never use a disc that has had a stabilizer mounted to it. The residual adhesive may cause the disc to stick to the mechanism of the CD-RW2000. If it sticks to the mechanism, you will need a technician to get it out.*

### 1.4.3 Handling of compact discs

Observe the following:

- Always place the compact discs in the trays with their label facing upward (compact discs can only be played on one side).
- To remove a disc from its storage case, press down on the center of the case, and lift the disc out, holding it carefully by the edges.



- Finger marks and dust should be carefully wiped off the disc's recorded surface with a soft cloth.

Unlike conventional records, the compact disc has no grooves to collect dust and microscopic debris, so gently wiping with a soft cloth should remove most particles.

- Wipe in a straight motion from the inside to the outside of the disc. Small dust particles and light stains will have absolutely no effect on reproduction quality.



- Never use such chemicals as record sprays, anti-static sprays or fluid, benzine or thinner to clean compact discs. Such chemicals will do irreparable damage to the disc's plastic surface.
- Discs should be returned to their cases after use to avoid serious scratches that could cause the laser pickup to "skip".
- Don't expose discs to direct sunlight or high humidity and temperature for extended periods. Long exposure to high temperature can warp the disc.
- Only use circular compact discs. Avoid using non-circular promotional, etc. discs.

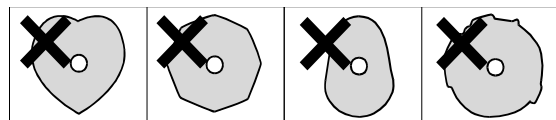

- To keep the laser pickups clean, don't touch them. For the same reason, don't leave the disc trays opened unnecessarily.

### 1.4.4 Additional notes with regard to CD-R and CD-RW discs

There are additional precautions that you should take when handling CD-R and CD-RW discs, that are different to those that you should take when handling ordinary CDs.

- Avoid touching the recording (non-label) side of a disc on which you will be recording. Recording on a disc requires a cleaner surface than playing back, and fingerprints, grease, etc. can cause errors in the recording process.
- CD-R discs are more sensitive to the effects of heat and ultraviolet rays than ordinary CDs. It is important that they are not stored in a location where direct sunlight will fall on them, and which is away



# 1 – Introduction—Environmental considerations

from sources of heat such as radiators or heat-generating electrical devices.

- Always store CD-R discs in their “jewel cases” to avoid dirt and dust accumulating on their surfaces.
- Do not put labels or protective sheets on the discs and do not use any protective coating spray.
- When labeling CD-R discs, always use a soft oil-based felt-tipped pen to write the information. Never use a ball-point or hard-tipped pen, as this may cause damage to the recorded side.
- Dirty discs may be cleaned using a soft dry cloth and/or a commercial CD cleaning fluid or ethyl alcohol. Do not use thinner, gasoline, benzene or LP cleaning fluid, as these will damage the disc.
- If you are in any doubt as to the care and handling of a CD-R disc, read the precautions supplied with the disc, or contact the disc manufacturer directly.

## 1.4.5 Recommended media

An up-to-date list of manufacturers who produce media suitable for use in the CD-RW2000 can be obtained from your TASCAM dealer, or found on the TASCAM Web site at <http://www.tascam.com>.

## 1.4.6 Default settings

The default settings when the CD-RW2000 is shipped from the factory are given below.

Setting	Description	Default value
Input selection	4.1, “Input selection”	Unbalanced
Auto track (A_TRACK)	4.3.2, “Automatic track division”	On
Auto ready (A_READY)	3.5, “Auto Ready function”	Off
Auto cue (A_CUE)	3.6, “Auto Cue function”	Off
Incremental play (INC_PLAY)	3.7, “Incremental play”	Off
Word sync (WORDSYNC)	2.4.1, “Word sync connections”	Off
Copy ID (COPY ID)	4.4, “Copy-protection”	1 generation
Digital direct (D_DIRECT)	4.3.3, “Digital direct”	Off
Trigger level (S_LEVEL)	4.3.1, “Synchronized recording”	-54 dB
FADE IN time	4.3.5, “Fade-in and fade-out”	3 seconds
FADE OUT time	4.3.5, “Fade-in and fade-out”	3 seconds
Digital Volume	4.1.1, “Signal volume”	0 dB
Play mode	3.1.3, “Playback modes”	Continue
Trim	4.5, “Rehearsal”	±0 frames

## 1.4.7 Dimensional drawing

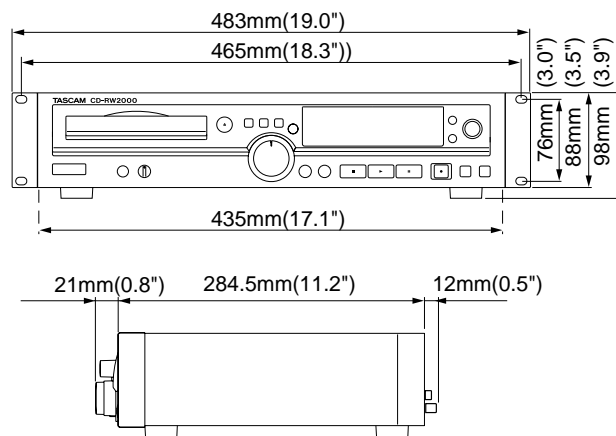

## 2 – Features of the CD-RW2000

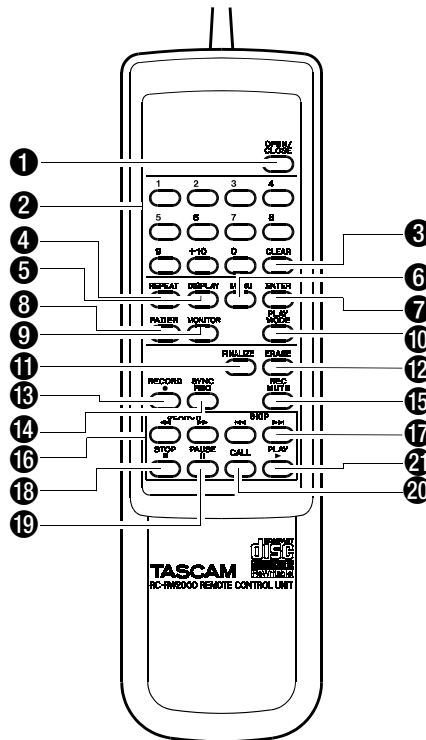
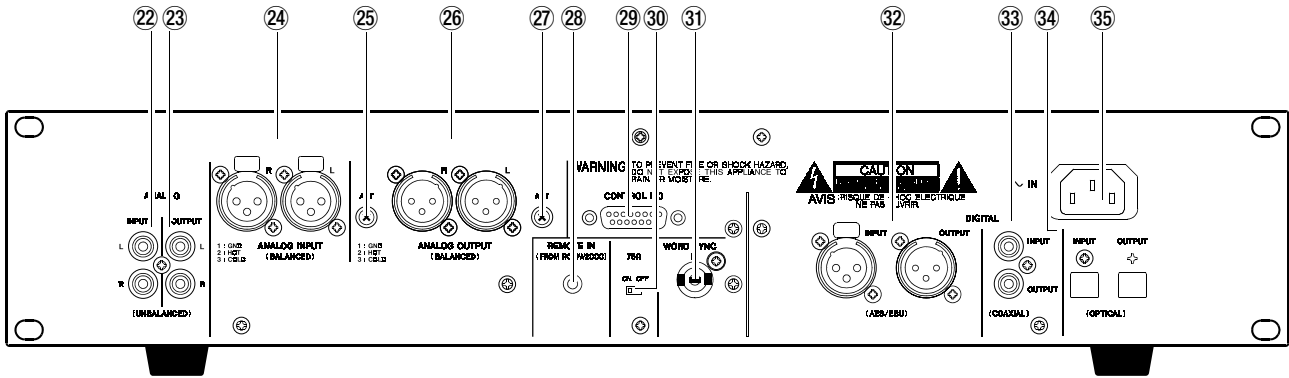
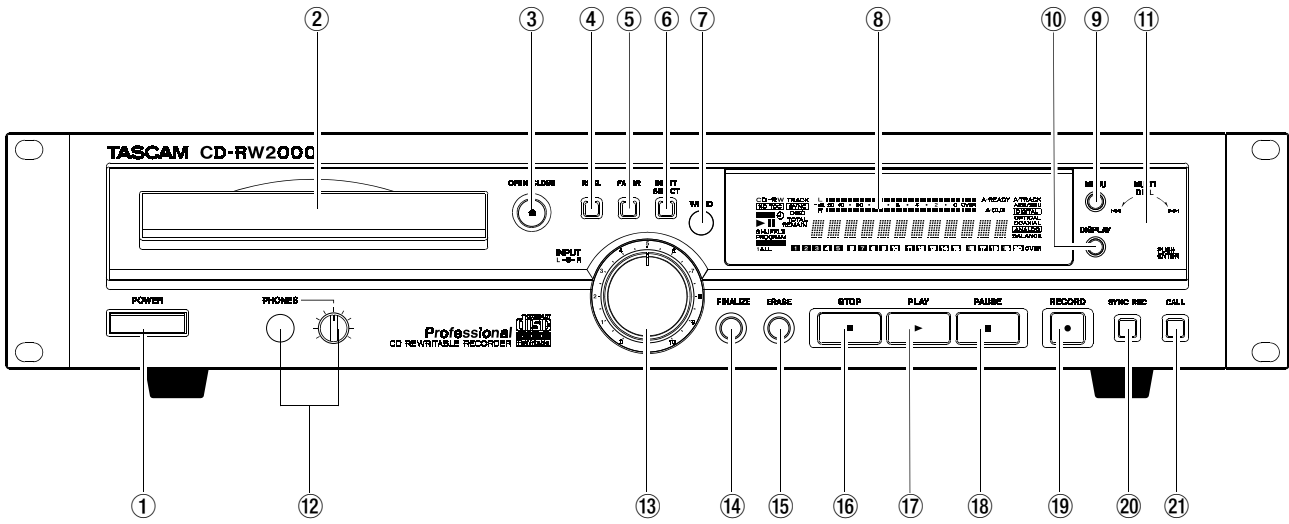

### 2.1 Front panel

#### ① POWER switch

The power switch is used to switch the unit between off and on (full operational mode).

When the unit is turned on, the display shows `Welcome!`.

#### ② Disc tray

Discs should be placed label side upwards in the disc tray.

When a disc is loaded into the unit, the display briefly shows `TOC Reading.`, with a flashing period following the word “Reading” as the unit determines the contents of the disc.

#### ③ OPEN/CLOSE key

Use this key to open and close the disc tray. The display shows `OPEN` when the tray is opening and `CLOSE` when the tray is closing.

#### ④ RHSL key

Use this key when recording to set and adjust the start point of a recording session or the start of a track on the recorded disc. See 4.5, “Rehearsal” for details.

#### ⑤ FADER key

Use this key to start fade-in recordings or to start a fade-out when recording (see 4.3.5, “Fade-in and fade-out” for details).

#### ⑥ INPUT SELECT

Repeated presses of this key cycle through the different audio inputs and the input combinations. See 4.1, “Input selection” for full details.

#### ⑦ WORD indicator

This indicator shows that an external word clock source has been selected (using a menu function) when using the unit with other digital audio units in a setup (see 2.4.1, “Word sync connections” for details).

#### ⑧ Display

The display is used to show the current status of the unit, as well as the current menu settings. See 2.2, “Rear panel” for details.

#### ⑨ MENU key

Repeated presses of this key cycle through the different menu items used to set parameters.

#### ⑩ DISPLAY key

Repeated presses of this key cycle through the different time display modes. These modes differ, according to whether the unit is playing back or recording a disc.

#### ⑪ MULTI DIAL control

Use this control to select tracks for playback, to set parameter values, etc.

Typically, turning the control clockwise will increase a value, and turning it counterclockwise will decrease the value. There is no “end-stop” to the control—it may be turned continuously in either direction.

In addition, when setting menu values, pushing the control acts like an “enter” key, i.e. the currently-displayed value or setting is confirmed and the display returns to the time display.

#### ⑫ PHONES jack and LEVEL control

Use a standard pair of stereo headphones, equipped with a 1/4-inch plug, with this jack.

Adjust the volume from the jack with the control (turn clockwise for higher volume).

#### ⑬ REC LEVEL controls

Use these concentric controls to adjust the level of the analog audio signals received at the **ANALOG IN** jacks ⑫. Typically, turning one of these controls will cause the other to turn, but they can be turned independently of each other.

Use the lower (outer) control to adjust the left signal, and the upper (inner) control to adjust the right signal.

Turning the controls clockwise past the “5” position will boost the signals relative to their input level, and turning them counterclockwise to a position below “5” will cut the signals relative to their original input level.

#### ⑭ FINALIZE key

Use this key to finalize recordable discs. See 1.2, “Finalizing” and 5.1, “Finalizing” for details.

#### ⑮ ERASE key

Use this key (with CD-RW discs only) to erase tracks, or a whole disc, or to refresh a “bad” disc, or to unfinalize a finalized disc. See 5.2, “Erasing” for details.

#### ⑯ STOP key

Use this key to stop playback or recording.

## 2 – Features of the CD-RW2000—Rear panel

### 17 **PLAY key**

Use this key to start or resume playback or recording.

### 18 **PAUSE key**

Use this key to pause playback or recording.

### 19 **RECORD key**

Use this key to enter record ready mode (see 4, “Recording” for details) and also to enter manual track divisions (see 4.2.3, “Manual track division”).

### 20 **SYNC REC key**

Use this key to turn synchronized recording on and off (see 4.3.1, “Synchronized recording” for details).

### 21 **CALL key**

Use this key for playback from the last pause position before playback starts (see 3.4, “CALL playback” for details).

---

## 2.2 Rear panel

---

### 22 **ANALOG INPUT (L, R) (UNBALANCED)**

These RCA jacks accept analog audio signals from suitably-equipped units (–10 dBV, unbalanced).

### 23 **ANALOG OUTPUT (L, R) (UNBALANCED)**

These RCA jacks output analog audio signals (at –10 dBV levels, unbalanced) to suitably-equipped units.

### 24 **ANALOG INPUT (L, R) (BALANCED)**

These XLR-type connectors accept analog audio signals from suitably-equipped units (+4 dBu, balanced). The wiring, as described on the rear panel of the unit is 1=ground, 2=hot, 3= cold.

### 25 **ATT (attenuation for right balanced analog output)**

Use a small Phillips screwdriver with this attenuator if you need to reduce the output signal level from the right balanced analog output. As set at the factory, a it is set to maximum output, and can reduce the level by 20 dB.

### 26 **ANALOG OUTPUT (L, R) (BALANCED)**

These XLR-type connectors output analog audio signals to suitably-equipped units (+4 dBu, balanced). The wiring, as described on the rear panel of the unit is 1=ground, 2=hot, 3= cold.

### 27 **ATT (attenuation for left balanced analog output)**

Use a small Phillips screwdriver with this attenuator if you need to reduce the output signal level from the left balanced analog output. As set at the factory, a it is set to maximum output, and can reduce the level by 20 dB.

### 28 **REMOTE IN (FROM RC-RW2000)**

Use this connector with the cable from the supplied RC-RW2000 remote control unit. Do not attempt to use any other type of remote control unit with the CD-RW2000.

### 29 **CONTROL I/O**

Use this 15-pin ‘D’-sub connector to connect the unit to suitably-equipped equipment, allowing control of the CD-RW2000. The pinouts of this connector are given in 2.4.2, “Control connections”.

### 30 **75Ω switch**

This switch is used to turn the termination for the **WORD SYNC** input (31) on and off. See 2.4.1, “Word sync connections” for details of word sync operations.

### 31 **WORD SYNC IN**

This BNC connector is used to accept word synchronization clock signals from other digital audio equipment in a setup. A menu function is used to select the source. See 2.4.1, “Word sync connections” for details of word sync operations.

### 32 **DIGITAL INPUT, OUTPUT (AES/EBU)**

This pair of XLR-type connectors accepts (female) and outputs (male) digital audio signals in AES3-1992 format.

### 33 **DIGITAL COAXIAL (IN, OUT)**

These two RCA jacks accept and output digital audio in standard IEC60958 Type II consumer format (SPDIF).

### 34 **DIGITAL OPTICAL (IN, OUT)**

These two TOSLINK optical connectors accept and output digital audio in standard IEC60958 Type II consumer format (SPDIF) using optical fiber connectors.

### 35 **~ IN (AC power inlet)**

Use the supplied power cable to connect the CD-RW2000 to the AC power supply. Always ensure that the voltage supplied is the same as that indicated on the rear panel of the CD-RW2000. If you are in doubt, consult a qualified electrician.

---

### 2.3 Remote control unit

---

#### ① OPEN/CLOSE key

Opens and closes the disc tray (equivalent to ③).

#### ② Number keys (0 through 10 and +10)

Use these keys for direct entry of track numbers when playing back, or making a programmed play list.

#### ③ CLEAR key

Use this key to clear a mistaken entry made with the number keys.

#### ④ REPEAT key

Use this key to change between the various repeat modes when playing back (see 3.3, “Repeat play”).

#### ⑤ DISPLAY key

Use this key to switch between the different display modes available (equivalent to ⑩).

#### ⑥ MENU key

Repeated presses of this key cycle through the different menu items used to set parameters (equivalent to ⑨).

#### ⑦ ENTER key

Pressing this key is equivalent to pressing the **MULTI DIAL** control ⑪ to confirm an entry.

#### ⑧ FADER key

Use this key to start fade-in recordings or to start a fade-out when recording (equivalent to ⑤).

#### ⑨ MONITOR key

Use this key to output the signals received at the currently selected input(s) through the outputs when not recording or in record ready mode.

#### ⑩ PLAY MODE key

Use this key to choose between the different playback modes (single play, continue play, etc.).

#### ⑪ FINALIZE key

Use this key to finalize recordable discs. See 1.2, “Finalizing” and 5.1, “Finalizing” for details (equivalent to ⑭).

#### ⑫ ERASE key

Use this key (with CD-RW discs only) to erase tracks, or a whole disc, or to refresh a “bad” disc, or to unfinalize a finalized disc. See 5.2, “Erasing” for details (equivalent to ⑮).

#### ⑬ RECORD key

Use this key to enter record ready mode (equivalent to ⑰).

#### ⑭ SYNC REC key

Use this key to turn synchronized recording on and off (equivalent to ⑳). See 4.3.1, “Synchronized recording” for details.

#### ⑮ REC MUTE key

Use this key when recording, to mute the input signal for about four seconds and then to enter record ready mode (see 4.3.4, “Rec mute function”).

#### ⑯ SEARCH keys

Use these keys to move the playback position inside a track.

#### ⑰ SKIP keys

Use these keys to move between tracks when playing back (equivalent to turning ⑪). They are also used to set the parameter values, etc.

#### ⑱ STOP key

Use this key to stop playback or recording (equivalent to ⑰).

#### ⑲ PAUSE key

Use this key to pause playback or recording (equivalent to ⑱).

#### ⑳ CALL key

Used to start playback from the last pause position before playback starts (equivalent to ㉑).

#### ㉑ PLAY key

Use this key to start playback, or enter record mode from record ready mode (equivalent to ⑰).

---

### 2.4 Connections

---

The following should be noted when you connect the unit to other equipment.

#### NOTE

*Do not connect or disconnect audio or other equipment to or from the CD-RW2000 while power is supplied to the units. Always turn off the power when connecting or disconnecting units.*

It is possible to connect the unit's **DIGITAL AES/EBU IN** ⑳, **DIGITAL COAXIAL IN** ㉑ and **DIGITAL OPTICAL IN** ㉒ to other equipment at the same time. However, the unit can receive signals from only one digital input at a time.

## 2 – Features of the CD-RW2000—Connections

Audio signals output from the unit are output from the balanced and unbalanced **ANALOG OUT** ⑳ ㉔ jacks, as well as from the **DIGITAL AES/EBU OUT** ㉓, **DIGITAL COAXIAL OUT** jack ㉔ and **DIGITAL OPTICAL OUT** connector ㉕ simultaneously.

### 2.4.1 Word sync connections

It may be necessary to synchronize the CD-RW2000 to an external audio word clock when playing back material. One example when this might be used is when the digital outputs of the CD-RW2000 are connected to a digital mixing console, which is serving as the word clock source for the setup.

In this case, the **WORD SYNC OUT** of the word clock master (the digital mixing console) should be connected to the **WORD SYNC IN** ㉑ of the CD-RW2000.

To select the external **WORD SYNC IN** signal as the CD-RW2000's clock source:

- 1 With a disc inserted, and the unit in stop mode (playback stopped), repeatedly press the **MENU** key (⑨ or ⑥) until the display shows **WORDSYNC>XXX** where **XXX** is either **ON** or **OFF**.
- 2 Use the **MULTI DIAL** control ⑪ or the **SKIP** keys ⑰ to set the function to **ON**.

The **WORD** indicator ⑦ will light if a valid clock source is available, otherwise the display will alternate the message **Word CLK Err** (word clock error) with the time display.

If the CD-RW2000 is receiving a word clock sync signal, and is also acting as the word clock source for any units which receive digital audio from the CD-RW2000 (remember that AES/EBU and IEC60958 signals are self-clocking), the **75Ω** terminator switch ⑳ should be set to **OFF**.

#### NOTE

Entering record ready mode (or record mode) with the word sync enabled will disable the word sync. The front panel **WORD** indicator ⑦ will go out.

If the CD-RW2000 is the last unit in the word clock chain, the **75Ω** terminator switch ⑳ should be set to **ON**.

#### NOTE

There should be one, and only one, word clock source in a digital audio setup. Multiple word clocks in a setup may result in damage to equipment.

### 2.4.2 Control connections

The pinouts of this connector ㉑ are:

Pin	Function
1	STOP TALLY OUT
2	REC/PLAY TALLY OUT
3	SKIP (forward) IN
4	SKIP (back) IN
5	REC-PAUSE TALLY OUT
6	REC IN
7	Track increment IN
8	GND
9	PLAY TALLY OUT
10	PAUSE TALLY OUT
11	FADER START/STOP
12	STOP IN
13	PLAY IN
14	PAUSE IN
15	+5V <sup>a</sup>

a. The maximum current supplied from this terminal is 50 mA.

Tally signals are open collector, with a maximum current of 50 mA. Input signals are active when low (ground) for  $\geq 30$  ms.

A fader start/stop control should be wired according to the following schematic:

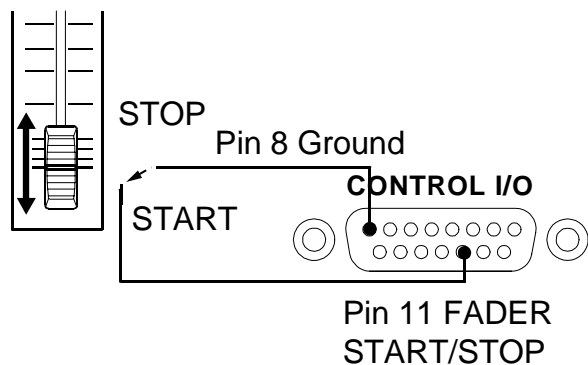

The CD-RW2000 can be used to play back CDs (including CD-R and CD-RW discs that have been recorded and finalized on other types of recorder), as well as CD-R discs and CD-RW discs that have been recorded on the unit.

### 3.1 Simple playback operations

- 1 Press the **OPEN/CLOSE** key (③ or ❶) to open the disc tray.
- 2 Discs should be inserted in the tray with the label uppermost.
- 3 Press the **OPEN/CLOSE** key (③ or ❶) to close the tray again.

When a disc is loaded into the unit, the display briefly shows **TOC Reading.**, with a flashing period following the word “Reading” as the unit determines the contents of the disc. When the TOC has been read, the display shows (at the top left of the display) one of the following:

CD	A commercial pre-recorded CD or a finalized CD-R
CD-R, NO TOC	A CD-R which has yet to be finalized
CD-RW, NO TOC	A CD-RW which has yet to be finalized
CD-RW	A finalized CD-RW (this differs from a CD, as it may be unfinalized and erased)
[blank]	Unusable or unreadable disc or no disc

- 1 Press the **PLAY** key (Ⓐ or ❷) to start playback
- 2 Press the **STOP** key (Ⓖ or ❸) to stop playback
- 3 Press the **PAUSE** key (Ⓗ or ❹) to pause playback temporarily.

The track number indicators at the bottom of the display light, to show the available unplayed tracks. If there are thirteen tracks on the disc, for example, indicators 1 through 13 will light. If there are more than 20 tracks on a disc, the track number **OVER** indicator (at the bottom of the display) will light.

#### 3.1.1 Time display modes

When playing back a CD (or in pause mode), there are four different time display modes.

In each mode, the current track number is given, followed by the time, as given below, e.g.

10Tr 0:48

Press the **DISPLAY** key (Ⓘ or ❺) to cycle through these time display modes, as described below:

Display shows	Meaning
TOTAL	Total elapsed time of the disc
[blank]	Elapsed time of the current track
TOTAL REMAIN	Time remaining of the current disc
REMAIN	Time remaining of the current track

#### NOTE

*If programmed playback has been selected (3.2, “Programmed order playback”), the elapsed time and total remaining time refer to the programmed material, not the whole disc.*

#### 3.1.2 Track search

Use the **MULTI DIAL** control (Ⓜ) or the **SKIP** keys on the remote control unit (Ⓡ) to jump forward or backward by one track at a time, as shown on the display.

Note that going forward from the last track of the disc will “wrap round” to track 1, and going backward from the first track of the disc will “wrap round” to the last track of the disc.

The track number indicators at the bottom of the display shows the selected track (the lit indicator at the left of the row of indicators).

It is also possible to use the number keys on the remote control unit (❶) to jump directly to a particular track:

- 1 To play tracks 1 through 9, simply press the appropriate key (1 through 9).
- 2 To play a track whose number is higher than 9, press the **+10** key an appropriate number of times to set the “tens” digit of the track number, followed by a single key to set the “units” digit. For example:

Track 13 = +10, 3

Track 30 = +10, +10, +10, 0

*On the remote control unit only, the **SEARCH** keys (Ⓢ) can be used to “fast-forward” and “fast-rewind” through the disc.*

#### 3.1.3 Playback modes

The unit can be set to play back the whole disc in the order in which it was created, the tracks of the disc in a random (shuffled) order, or a programmed order (see 3.2, “Programmed order playback”).

## 3 – Playback operations—Programmed order playback

### NOTE

Selecting the playback mode is only possible using the remote control unit. It is not possible to select the playback mode using the main unit alone.

1 Press the **PLAY MODE** key (10) repeatedly to cycle the display through the following:

- **Program** (see 3.2, “Programmed order playback” below). The red PROGRAM display indicator lights in this mode.
- **Shuffle** (random track order). In this mode, each track is played once before the disc repeats. Using the track search functions will move backwards or forwards through the random order, e.g. if track 7 is followed by track 10, it is possible to use the track search keys to go back to track 7, which is remembered as being before immediately before track 10. The red SHUFFLE display indicator lights in this mode.
- **Continue**. Normal playback mode. Programming is cancelled, and playback continues in the normal order.

The selected mode is shown in large characters and disappears from the display a few seconds after selecting the mode, when the display returns to its previous mode.

### 3.2 Programmed order playback

The steps to set up to 25 program steps (tracks) to be played back in a specified order are as follows:

- 1 Press the **PLAY MODE** key (10) until the display shows **Program**.
- 2 The display changes to show  
0Tr 0:00 00,  
meaning that no program steps have yet had tracks assigned to them.
- 3 Use the number keys to enter a track number (including the +10 key to enter values greater than 9, as described in 3.1.2, “Track search”). There is no need to press ENTER.

The track entered is assigned to the program step, and the display changes, showing the track number, the total time of the program so far, and the step number, e.g.

2Tr14:56 03.

- 4 The next program step can then be entered.

### NOTE

Steps 3 and 4 above can be carried out from the main unit by turning and pushing the **MULTI DIAL** control (11).

- 5 Repeat steps 3 and 4 above until the program is complete.

- 6 Press the **PLAY** key (17) or (21) to start playback at the first program step.

The display shows the track, the current time display, and the program step number.

While in programmed playback mode, using the **SKIP** keys (17) or the **MULTI DIAL** control (11) moves backwards and forwards in the order set in the program.

Use the **PAUSE** key (18) or (19) to halt playback temporarily or the **STOP** key (16) or (18) to stop playback of the program.

If the **STOP** key is used, when playback is restarted, it starts from the first program step.

Clear the program by pressing **PLAY MODE** (10) until the display shows **Continue**. The program is also cleared when the disc tray is opened, and if the **STOP** key is pressed when playback is stopped in programmed order mode.

The programmed play order is not memorized when power is turned off.

If an attempt is made to enter more than 25 program steps, the message **PGM Full !** appears on the display.

### 3.3 Repeat play

The unit can repeat the whole of the disc (or program) or the current track only.

### NOTE

Selecting the repeat mode is only possible using the remote control unit. It is not possible to select the repeat mode using the main unit alone.

- 1 The unit should be in playback, pause or stop mode.
- 2 Continue to press the **REPEAT** key (4) so that the display shows **Repeat 1** (the REPEAT 1 indicator lights) to repeat one track, or **Repeat ALL** (the REPEAT ALL indicator lights) to repeat the whole disc or program.
- 3 If playback has not started, restart it.

To cancel repeat mode, press the **REPEAT** key so that the display shows **Repeat OFF** and the REPEAT indicator goes out.



### 3.4 CALL playback

The **CALL** keys (21) and (20) allow the unit's playback position to be returned to the point at which playback last started from pause mode. If there is no "call point" (i.e. playback starting from pause), pressing the **CALL** key will have no effect. It should also be noted that this call function is available in play and pause modes only.

Note that the call mode is not available when shuffle mode has been selected (see 3.1.3, "Playback modes") and there is no "call point" set.

### 3.5 Auto Ready function

This function allows the playing back of a single track, and the automatic cueing of the next track ready for playback.

The unit is cued to the start of the track as determined by the subcode, not the start of the audio signal, unless the **AUTO CUE** function is on (see 3.6, "Auto Cue function").

The unit will enter pause mode in the continue, shuffle and programmed play modes, after the location has taken place.

If repeat is active (see 3.3, "Repeat play"), the unit will enter play ready mode at the start of the next track (REPEAT ALL), or the start of the track which is being repeated (REPEAT 1).

To set the function:

- 1 Repeatedly press the **MENU** key (9) or (6) until the display shows **A\_READY>XXX** where **XXX** is either **ON** or **OFF**.
- 2 Use the **MULTI DIAL** control (11) or the **SKIP** keys (17) to set the function to **ON**.

When the function is on, the **A-READY** display indicator is lit.

### 3.6 Auto Cue function

The Auto Cue function allows you to set up the unit so that when a track is selected for playback in pause mode (cued), playback will start, not at the first posi-

tion of the track as indicated by the subcode, but at the first position of the track where the audio level exceeds a set trigger level.

The trigger level is the same as the recording trigger level, as set in 4.3.1, "Synchronized recording". Consult this section on how to set the trigger level.

To set the Auto Cue function on:

- 1 Repeatedly press the **MENU** key (9) or (6) until the display shows **A\_CUE > XXX** where **XXX** is either **ON** or **OFF**.
- 2 Use the **MULTI DIAL** control (11) or the **SKIP** keys (17) to set the function to **ON**.

When the function is on, the **A-CUE** display indicator is lit.

#### NOTE

When using the Auto Cue function, there may be a short "click" sound output through the **DIGITAL COAXIAL** and **OPTICAL OUT** terminals (33) and (34) as the unit locates to the audible start of the track just before it enters pause mode. However, this sound will not be output through the **DIGITAL AES/EBU OUT** terminal (32).

### 3.7 Incremental play

Incremental playback means that when the **STOP** key (16) or (18) is pressed (or if a STOP signal is received through the **CONTROL** connector (29)) while a track is being played back, the playback position will be at the start of the next track.

If the **PLAY** key (17) is pressed while the incremental playback mode is on, playback starts from the start of the next track.

To set the incremental play mode on:

- 1 Repeatedly press the **MENU** key (9) or (6) until the display shows **INC PLAY>XXX** where **XXX** is either **ON** or **OFF**.
- 2 Use the **MULTI DIAL** control (11) or the **SKIP** keys (17) to set the function to **ON**.

Although there is no indication when the incremental play mode is selected, you will notice that is in operation whenever you stop playback of a track.

## 4 – Recording

Before you start recording using the CD-RW2000, make sure that you understand the following key points:

- Once you have recorded on a CD-R disc, the data cannot be erased from it.
- You can add tracks to an unfinalized recordable disc. Once finalized, a CD-R disc is “fixed” and behaves in the same way as a pre-recorded disc. Finalized CD-RW discs, however, can be erased, refreshed and re-recorded.

### 4.1 Input selection

To select the input to be recorded, press the **INPUT SELECT** key on the main unit (6).

Repeated presses of the key cycle through the following options:

Un Bal	Unbalanced analog
Balance	Balanced analog
Optical	Optical digital
Coaxial	Coaxial digital
AES/EBU	AES/EBU digital

In the case of the AES/EBU, coaxial or optical inputs being selected, the boxed DIGITAL indicator shows on the display, and the appropriate indicator: AES/EBU, COAXIAL or OPTICAL, lights on the display.

If the analog signal is selected the boxed ANALOG indicator lights on the display, together with the BALANCE indicator in the case of balanced analog inputs.

#### 4.1.1 Signal volume

- The analog signals received at the **ANALOG IN** jacks are controlled with the **REC LEVEL** controls (13).
- Digital signal levels (from whatever the source) as well as the level of analog signals once they have passed through the **REC LEVEL** controls are adjusted in the following way:

- 1 Press the **RECORD** key (19) or (13) to place the unit in record ready mode.
- 2 Repeatedly press the **MENU** key (9) or (6) until the display shows **VOLUME XXXdB** where **XXX** is the current setting.
- 3 Use the **MULTI DIAL** control (11) or the **SKIP** keys (17) to adjust the input volume between **-60dB** and **+18db** (relative to the origi-

nal input level). There is also a **---** setting which represents a complete signal cut.

#### NOTE

*If digital direct is selected, as described below (4.3.3, “Digital direct”), the digital volume is bypassed and this menu item disappears. However, once the digital direct mode is turned off, the menu reappears, the settings previously made here will take effect, and the input volume may suddenly change.*

#### 4.1.2 Input monitoring

When the unit is in record ready, or record mode, the input signal is output from the **OUT** jacks (digital and analog), allowing you to hear the input signal.

The meters also show the current signal level.

However, it is only possible to record, or to enter record ready mode, when a recordable disc is inserted. To allow monitoring of the input signal at other times, or when the unit is stopped, use the **MONITOR** key on the remote control unit (9).

The **RECORD** key (19) on the main unit will also enter monitor mode from stop mode when there is no recordable disc in the unit (when there is a recordable disc in the unit, pressing the **RECORD** key enters record ready mode).

The word **MONITOR** appears on the display to show that the output signal is an echo of the input signal(s). The meters show the current input level.

Exit the monitor mode by using the **STOP** key.

#### 4.1.3 Frequency conversion

The sampling frequency for CDs is 44.1 kHz. The CD-RW2000 will always record (and play back) CDs at this frequency.

However, if recording through a digital connection (either AES/EBU, coaxial or optical) and the source has been recorded at a frequency other than 44.1 kHz, or is being played back at a non-standard speed using a varispeed unit (more than 0.02% away from the standard), the CD-RW2000’s internal frequency converter can automatically convert the incoming frequency to 44.1 kHz.

#### NOTE

*If the sampling frequency convertor is turned off using the digital direct function (4.3.3, “Digital direct”), recording from digitally-connected devices is only possible when the source frequency is 44.1 kHz. If an attempt is made to record from a digitally-connected source at a different frequency, the error message **Not F=44.1k!** is displayed.*

## 4.2 Basic recording

### NOTE

According to the “Red Book” (the specification for audio CDs), a track cannot be less than four seconds in length, and there can be a maximum of 99 tracks on an audio CD. Bear these limitations in mind when recording.

If you press either the **STOP** or the **PAUSE** key within four seconds of starting recording, the unit will continue recording until four seconds have elapsed (since the start of recording) and then stop or pause as appropriate.

After selecting the input source (4.1, “Input selection”), it is possible to start recording.

The basic record procedure is as follows:

- 1 **Load a recordable disc into the unit. As the disc is loaded, the display shows TOC Reading.**

**When the disc has been loaded, the display indicators show CD-R, NO TOC, or CD-RW, NO TOC, as appropriate.**

- 2 **Press the RECORD key (19) or (18). The unit enters record ready mode, as shown by the REC and pause indicators on the display. As the unit enters record ready mode, the display shows Now OPC (Optimum Power Control), as the unit prepares to record on the disc.**

**If the digital source selected (see 4.1, “Input selection”) is not connected properly, or is not powered up, the message D – IN UNLOCK! (digital input is unlocked) will be displayed to show that the system is not ready to record.**

- 3 **Adjust the level of the source, following the guidelines in 4.1.1, “Signal volume”.**

### NOTE

The red OVER indicators on the meters should never light. Unlike analog equipment, digital audio units produce extremely unpleasant sounds when distorted, and there is no “headroom” after the 0 mark. If recording digitally from a commercially-produced CD, the volume set in the menu should be 0 dB. This will maintain all the dynamic range of the source CD without clipping. Only boost the signal if the source is exceptionally quiet.

An analog signal input at nominal level, with no cut or boost from the volume controls, is equivalent to a reading of –16 dB on the meters (on other words, 0 is equivalent to 16 dBFS).

- 4 **Press the PLAY key (17) or (21) to start recording.**

Note that there is no need to “cue up” the recording position—the unit always finds the next available location on the disc and start recording to it.

- 5 **Press the PAUSE key (18) or (19) to pause recording temporarily. The pause indicator on the display shows this.**

Pressing PLAY again restarts recording with a new track number.

- 6 **Press STOP (16) or (18) to stop recording. When recording stops, the display shows PMA Writing (Program Memory Area) and the REC indicator flashes for a few seconds as the unit writes to the disc.**

### NOTE

While the “PMA Writing” message is displayed, all keys are disabled, and the unit is actually writing to disc. Do not disconnect the power or subject the unit to severe vibration or shocks at this time, as this will prevent proper recording of the information.

**When this message disappears, you must press the RECORD key (step 2) before restarting the recording. Recording restarts with a new track number.**

### NOTE

Remember that every time recording is paused or stopped, when recording is restarted, a new track will always be started. It is not possible to record in two “stages” within one track.

### 4.2.1 Playing back tracks

Although an unfinalized disc cannot be played back on an ordinary CD player, the CD-RW2000 can play back tracks that have been recorded.

Use the **MULTI DIAL** control (11) or the **SKIP** keys (17) to select a track for playback.

### 4.2.2 Time display while recording

While a recordable disc is being played back, the four time display modes available in normal playback as described in 3.1.1, “Time display modes”: TOTAL, TOTAL REMAIN, track REMAIN and elapsed track time.

However, during recording there are fewer options available (obviously, the unit cannot see into the future and know how much time remains of the track which is being currently recorded!).

## 4 – Recording—Advanced recording

When in record or record ready mode, repeated presses of the **DISPLAY** key (⑩ or ⑤) cycle between displaying the remaining time left for recording on the disc (TOTAL REMAIN) and the elapsed time of the track currently being recorded (no indicator lit).

When playback is stopped at the start of a recordable disc, there are only two options available: TOTAL (the total time recorded so far on the disc) and TOTAL REMAIN (the total time available on the disc for further recording).

### 4.2.3 Manual track division

It is possible to divide the recording into tracks “on the fly” while recording.

There are three options available for track division: automatic division triggered by the subcode when making a digital recording, track divisions triggered by a rise in sound level, and manual settings.

To make manual track divisions, while recording is taking place, press the **RECORD** key (⑲ or ⑬). The current track number is incremented by one.

For details of automatic track division while recording, see 4.3.2, “Automatic track division”.

#### NOTE

*According to the “Red Book” (the specification for audio CDs), a track cannot be less than four seconds in length, and there can be a maximum of 99 tracks on an audio CD. Bear these limitations in mind when adding track divisions.*

### 4.2.4 Restricting the number of tracks

When making a recording using the CD-RW2000, it is possible to restrict the number of tracks that may be recorded at one time. This applies whether the tracks are being divided manually, as described above (4.2.3, “Manual track division”) or being divided automatically (4.3.2, “Automatic track division”).

At any time within record or record ready mode, turn the **MULTI DIAL** control (⑪) or use the **SKIP** keys (⑰).

This sets the number of remaining tracks, as shown to the right of the time display. The maximum number here is limited by the standard limit of 99 tracks, and the number of tracks currently recorded.

Every time a track division is made, the number shown at the right of the display goes down by one. When the number shown is 1, and a track division is made, the display shows **PMA Writing** and the unit enters stop mode.

The number of remaining tracks can be changed during recording using the **MULTI DIAL** control.

### 4.2.5 Full disc

If recording a long program, and the number of tracks has not been restricted, when there is no space remaining on the disc for recording, as shown by the time display (see 4.2.2, “Time display while recording”), just before the end of the disc is reached, the unit starts a fade-out over a few seconds (the display shows **FADE OUT**).

When the fade-out has finished, the display shows **Disc Full!!** for a few seconds, and the unit then goes into stop mode (the display shows **PMA Writing**).

If the disc is a CD-RW, the final track can be erased, if required (see 5.2.1, “Erasing tracks”) and the disc then finalized. If the disc is a CD-R, it must be finalized prior to use (see 5.1, “Finalizing”).

---

## 4.3 Advanced recording

---

These sections cover more advanced recording techniques.

### 4.3.1 Synchronized recording

Synchronized recording means that recording will begin automatically when a signal is received, and will stop when the signal ends.

To enable or disable synchronized recording:

- 1 **A recordable disc must be loaded.**
- 2 **With the unit in record ready or record mode, press the SYNC REC key (⑳ or ⑭).**

**The display shows SYNC ON briefly, and then changes to the track and time display. When synchronized recording is enabled, the SYNC indicator lights in the display.**

**The SYNC REC key is also used to turn off synchronized recording (the display briefly shows SYNC OFF and then returns to the track and time display).**

The signal level which may be used with synchronized recording operations as well as some playback operations (3.6, “Auto Cue function”) here called the “trigger level” or “threshold”, is set as below:

- 1 **With a recordable disc loaded, press the MENU key (⑨ or ⑥) until the display shows: S\_LVL> xxdB, where xx is the current value.**

## 4 – Recording—Advanced recording

- 2 Turn the **MULTI DIAL** control ⑪ or use the **SKIP** keys ⑰ to change the value between **DD**, -24, -30, -36, -42, -48, -54, -60, -66, and -72 dB.

Low numerical values of this setting (towards -24) mean that it takes a louder signal to trigger the start of the synchronized recording. A high numerical value (towards -72) means that a relatively quiet signal will trigger the start of recording.

The **DD** setting is a special case. It is not a signal level, but refers to the start of a track, as encoded in the digital input signal. It is therefore only used when a digital input is received on the **COAXIAL** or **OPTICAL** digital inputs (but not the **AES/EBU** inputs).

### NOTE

If the **CD-RW2000** is used to record a digital audio source which is connected using analog connections, even if the **DD** setting above is made, the trigger level will automatically be set to -54 dB.

Also note these points when making digital recordings from a CD player or a DAT player when using the **DD** setting.

Since the **DD** setting pays no attention to the sound level, but only to received subcode, it is possible that when the **CD-RW2000** is in record ready mode and a CD is selected as the digital recording source, and the source CD is changed, when the source player reads the TOC of the source disc, when the first track is read, a spurious signal will be sent to the **CD-RW2000**, which will start recording.

Also, when a digitally-connected DAT is used as the source, and the tape is wound fast (forward or backward) to cue the source tape to the start of the desired track, you should remember that **START IDs** will be sent from the DAT deck while the fast wind is proceeding. These **START IDs** will also trigger recording if the **CD-RW2000** is in record ready mode, and the **DD** setting is selected.

For these reasons, we suggest that you only switch on the **DD** setting when the source CD player or DAT deck is in **STOP** mode.

The conditions under which an input signal is used as the trigger to start recording are:

- when recording digitally, a digital start signal is detected, and audio is subsequently detected

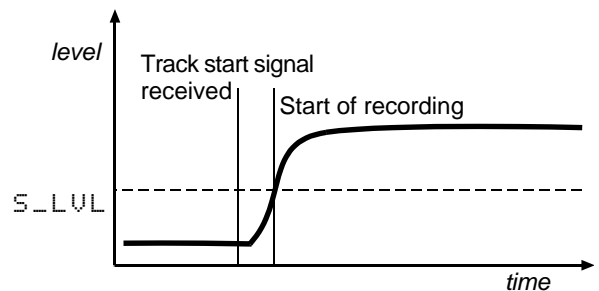

or

- the sound level rises above the threshold (see below) after having been below the threshold for one second or more. Note that the diagram below represents a special case (the source is stopped or paused) of the more general condition, as explained later:

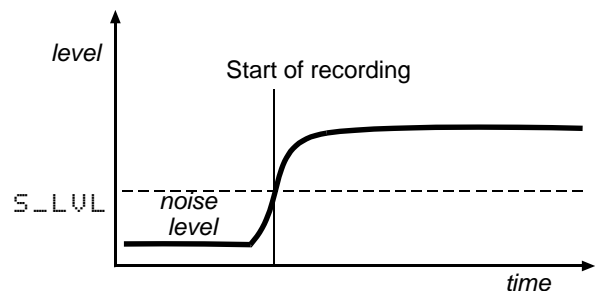

To start synchronized recording when the source is stopped or in pause mode:

- 1 **The unit must be in record ready mode, and the SYNC indicator in the display must be lit, as explained above.**
- 2 **Start playing the source. The pause indicator disappears from the display, and the unit starts recording.**

The conditions under which synchronized recording stops are:

- when recording digitally, an appropriate digital signal is detected. If the signal is detected from a CD, the unit enters record ready mode after 2 seconds.

## 4 – Recording—Advanced recording

If the signal is detected from an MD, the unit enters record ready mode immediately:

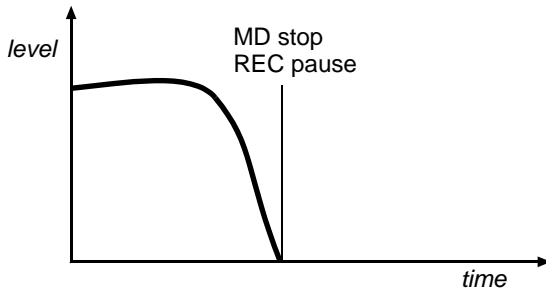
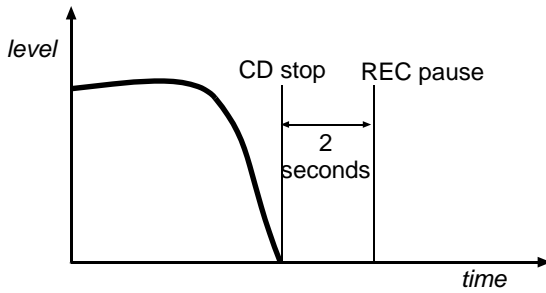

Note that the trigger level is not used here.

or

- the sound level drops below the threshold level for five seconds

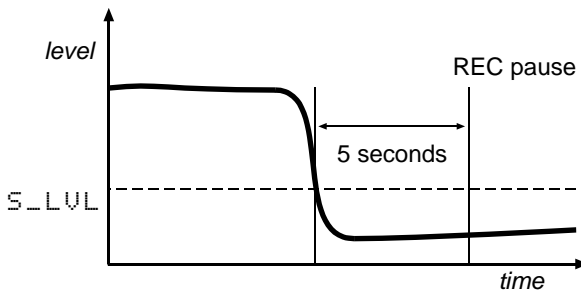

If you set the threshold value so that only high-level signals trigger recording, remember that this will not record the start of a piece with a slow fade-in:

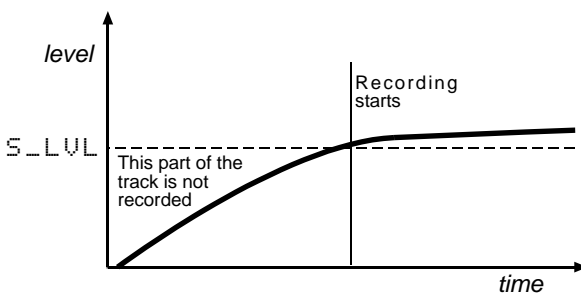

Also remember that when recording from an analog source, the threshold should be set so that it is higher than the “noise floor” (the base level of hiss, pops and crackles which may come from an older vinyl recording, for example). If the “noise floor” is higher than the threshold, synchronized recording will not

take place (the rehearsal facility can be used here (4.5, “Rehearsal”) to help):

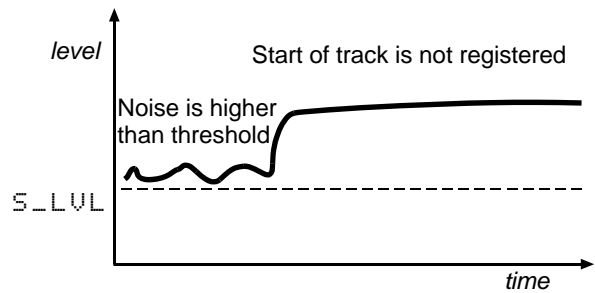

Because synchronized recording can be turned on and off while recording is taking place, it is therefore possible to record with a synchronized automatic start, and a manual end, or *vice versa*.

When the source material is being played back before synchronized recording is enabled, the conditions under which synchronized recording will start (after synchronized recording has been enabled) are:

When the signal drops below the threshold for one second or more and then rises above the threshold again (this is the general condition, of which starting synchronized recording from a stopped or paused source is a special case):

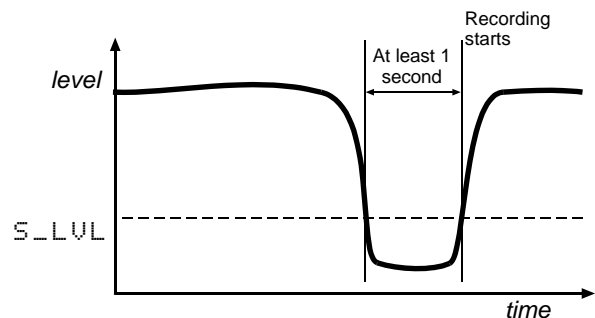

Alternatively, when recording digitally from sources (MD, CD and DAT) which output track divisions, synchronized recording starts when a track division is received, regardless of the level:

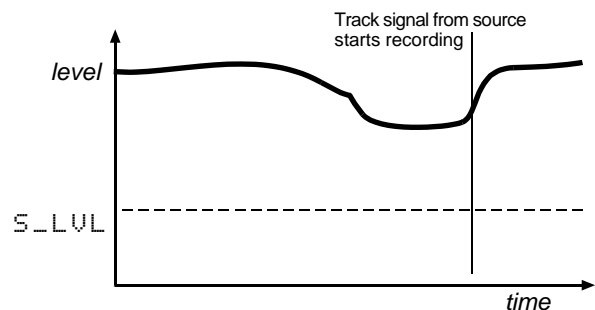

To stop synchronized recording:

- 1 **The unit must be in record mode, and the SYNC indicator in the display must be lit.**

## 4 – Recording—Advanced recording

- 2 **Stop the source.** After a few seconds, the unit enters record ready mode. The time between the stopping of the source and entering record ready mode is used to record a gap at the end of the track.
- 3 **If no changes are made to the unit's controls, restarting the source restarts recording, as the unit is still in sync mode and will start recording again when the source is detected.**

### NOTE

When recording in sync mode, you may notice a slight delay between starting the source, and the CD-RW2000 responding. This is due to the way in which the unit works, storing the data in a memory buffer before writing it to the disc. The resulting delay is therefore not a cause for concern—all audio data received between the start and end points will be recorded.

### 4.3.2 Automatic track division

The trigger level, as set above (4.3.1, “Synchronized recording”) can also be used to divide tracks if the A-TRACK (auto track) function is enabled. When this function is enabled, the unit automatically inserts a track division in the recorded material when:

- recording digitally from MD, CD or DAT, an increment signal is detected and the sound level rises above the threshold:

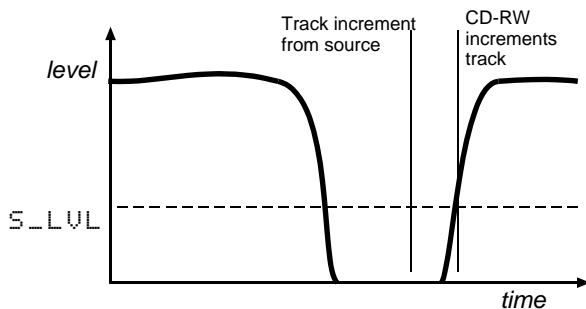

or

- increment signals are unavailable (e.g. analog recording or digital sources other than MD, CD or DAT) and the sound level has dropped below the

threshold for more than two seconds, and sound has re-started

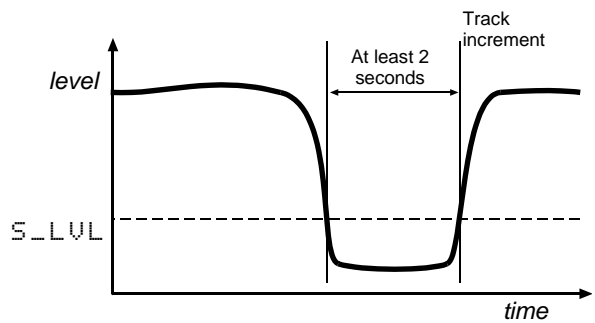

To enable or disable automatic track division:

- 1 **With a recordable disc inserted, and with the unit in record ready mode, press the MENU key (9 or 6) repeatedly until A\_TRACK >XX is shown, where XX may be ON or OFF.**
- 2 **Turn the MULTI DIAL control (11) or use the SKIP keys (17) to change the value to ON or OFF.**

**The A-TRACK indicator at the top right of the display lights when the auto track function is enabled.**

Automatic track division can be turned on or off while recording is taking place.

### NOTE

When recording certain types of material (e.g. certain types of classical music or spoken word) through the analog connections, since the track divisions are determined by relative silence, it is possible that spurious track divisions will be inserted. Under these conditions, it may be better to use manual track division (4.2.3, “Manual track division”).

However, if recording through a digital connection, the track number will be incremented only when a track division signal is received, followed by a rise in volume.

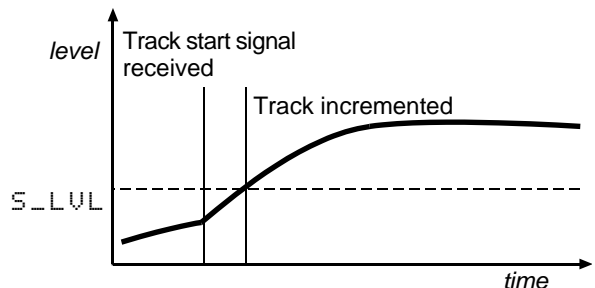

A fall and subsequent rise in volume alone when recording digitally from CD, MD or DAT is not sufficient to trigger an

## 4 – Recording—Advanced recording

automatic track increment.

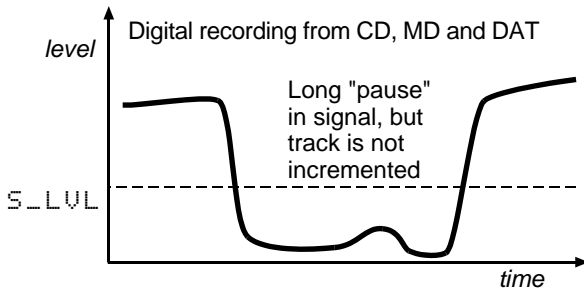

You may find it helpful to use the track restriction facility (see 4.2.4, “Restricting the number of tracks”) together with the automatic track division.

For instance, if you have recorded two albums on one DAT tape, and you wish to make two separate CDs from this tape, you can use the **MULTI DIAL** control to set the number of tracks to the number of tracks comprising the first album.

When the final track of the first album has been recorded, the unit automatically performs the PMA writing procedure and enters stop mode.

### 4.3.3 Digital direct

As mentioned earlier, the digital direct mode bypasses some of the input circuitry of the CD-RW2000 (the frequency convertor and the digital level control) to write directly to the disc.

To enable or disable digital direct recording:

- 1 Ensure that the input source is set to DIGITAL (either AES/EBU, COAXIAL or OPTICAL).
- 2 Press the MENU key (9) or (6) repeatedly until the display shows `D_DIRECT>XXX`, where `XXX` is the current setting, either ON or OFF.
- 3 Turn the MULTI DIAL control (11) or use the SKIP keys (17) to change setting to ON or OFF.

When digital direct recording is enabled, the DIGITAL indicator in the display flashes slowly when the unit is in record ready mode, or is recording.

#### NOTE

As mentioned earlier, the digital direct feature bypasses the frequency convertor. Recording is therefore only possible from sources recorded with 44.1 kHz sampling frequency.

If digital direct is selected, the digital volume is bypassed and the menu item disappears. Once the digital direct mode is turned off, the level settings pre-

viously made will take effect, and the input volume may suddenly change.

### 4.3.4 Rec mute function

The rec mute function allows instant cut-off of the input signal, and records four seconds of silence on the disc.

- 1 While recording is in progress, press the REC MUTE key (15).

The display shows `REC MUTE`, the meters stop displaying the current level and the monitored sound is cut.

- 2 After about four seconds, the unit enters record ready mode.

#### NOTE

This function is only available from the remote control unit. It is not possible to use this function with the main unit only.

### 4.3.5 Fade-in and fade-out

To provide smooth beginnings and endings to recorded tracks, the unit provides fade facilities.

Fade-ins are from  $-\infty$  (silence) to the set input level (4.1.1, “Signal volume”) and fade-outs go from the current input volume to silence.

The fade-in and fade-out times can be set independently in increments of one second, from 1 second to 24 seconds.

To set the fade times:

- 1 Press the MENU key (9) or (6) repeatedly until the display shows `FADE IN > XXS`, where `XX` is the current fade-in time, in seconds.
- 2 Turn the MULTI DIAL control (11) or use the SKIP keys (17) to change the value of the fade-in time.
- 3 Press the MENU key again so that the display shows `FADE OUT > XXS`, where `XX` is the current fade-out time, in seconds.
- 4 Turn the MULTI DIAL control or use the SKIP keys to change the value of the fade-out time.

It is possible to set the fade-in time only (perform step 5 after step 2) or the fade-out time only (in step 1, press the MENU key until the fade-out time menu item is shown).

To perform the fade-in:



- 1 With a recordable disc loaded, press the **RECORD** key (⑰ or ⑱) so that the unit enters record ready mode.
- 2 Start the source material, and press the **FADER** key (⑤ or ⑧).

The display shows **FADE IN** for the time specified in the menu item above.

As the fade progresses, the monitored signal gradually becomes louder, reflecting the level recorded on disc.

To perform a fade-out:

- 1 While recording, press the **FADER** key (⑤ or ⑧).

The display shows **FADE OUT** for the time specified in the menu above.

As the fade progresses, the monitored signal gradually becomes quieter, reflecting the level recorded on disc.

- 2 When the end of the fade-out time is reached, the unit goes into record ready mode. Recording can be restarted with the **FADER** key or the **PLAY** or **PAUSE** keys.

It is not possible to change the fade-in and fade-out times to new values while recording is in progress.

Fades are also possible in digital direct mode (4.3.3, “Digital direct”).

### 4.4 Copy-protection

The CD-RW2000 allows copy-protection to be applied to the discs produced. Naturally, the copy-protection applies only to digital-to-digital copies.

There are three settings:

- **FREE** (may be freely copied), where no copy-protection is applied to the recorded disc.
- **1 GEN** (single-generation copying), where one digital copy (“child”) can be made from the recorded disc, but no digital copies (“grandchildren”) can be made from the child.
- **PROH** (copy prohibited) which prevents any digital copies being made from the recorded disc

- 1 Press the **MENU** key (⑨ or ⑥) repeatedly until the display shows **COPY ID>XXXX**, where **XXXX** is the current setting for copy-protection as shown above.

- 2 Turn the **MULTI DIAL** control (⑪) or use the **SKIP** keys (⑰) to change the copy-protection setting.

#### NOTE

*Copy-protection applies on a “per-track”, not a per-disc basis. This means that you can apply different copy-protection levels to different tracks (but you can’t apply different copy-protection levels to different parts of the same track). If copy-protection is important to your work, you may want to check this setting every time you make a recording, to ensure that you have the protection level that you want.*

### 4.5 Rehearsal

There are two areas in which the unit’s rehearsal facilities can be used: synchronized recording (4.3.1, “Synchronized recording”) and automatic track division (4.3.2, “Automatic track division”).

The purpose of the rehearsal facilities is to allow you to override the automatic synchronized recording and track division facilities where necessary.

Here is an example where this facility may be of value:

A piece has been recorded on DAT, with a verbal count-in immediately prior to the first drum beat. This count-in is not to be recorded as a part of the CD track, but the threshold level has been set to a level where the fourth count will trigger recording (–24 dB — this is the limit of the threshold sensitivity and cannot be adjusted further).

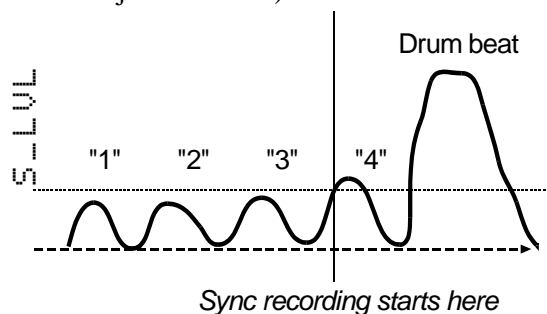

When the rehearsal facility is used, the source is cued up and played, and the first few seconds of the track

## 4 – Recording—Rehearsal

are sampled and looped. The position of the loop can be adjusted.

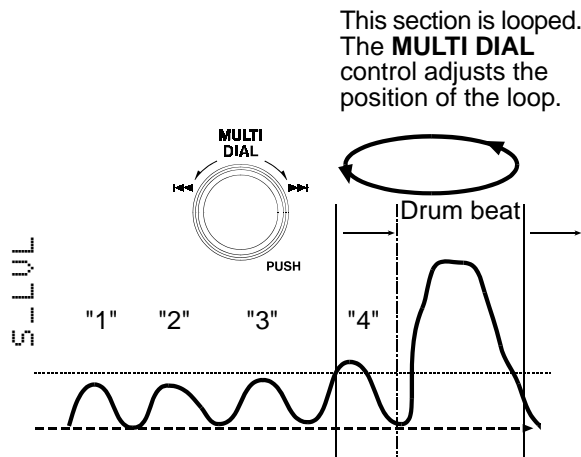

When this offset has been set, synchronized recording takes place with the start occurring at the new location:

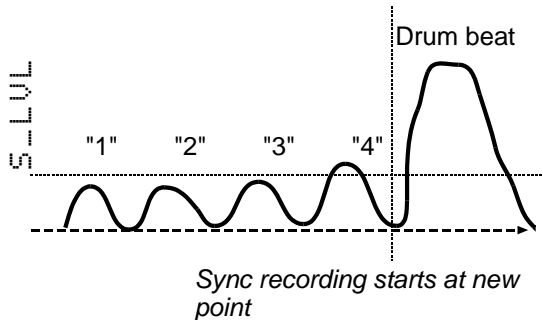

This example shows how the start time can be moved forward, in order to eliminate unwanted “false starts”. It is also possible to “slip” the start time backwards, in order to record a quiet passage that would otherwise not trigger the sync recording facility (this is done by the use of a memory buffer).

As well as being used for changing the start time of synchronized recording, the start of an automatic track division can also be trimmed backwards and forwards in a similar way.

Both the sync start trim and the track start trim can take the same value and can be used in the same recording.

The maximum trim value is 125 frames on either side of the original point (represented by  $\square$ ), where there are 75 frames in a second (i.e. 1.67 seconds).

### 4.5.1 Rehearsal for synchronized recording

To perform a synchronized recording, using the rehearsal mode to slip the start of the track forwards or backwards:

- 1 Load a recordable disc into the unit and make sure the unit is in stop mode.
- 2 Cue the source material to the start of the source track to be recorded (i.e. in the example above, this would be just before the count-in).
- 3 Press the RHSL key (4) so that the display shows `Waiting Sync`.
- 4 Start playing the source. When the start of the track is detected (as explained in 4.3.1, “Synchronized recording”), the display changes to `Sync RHSL`.
- 5 If the rehearsal does not start at the region of the true start point, press the RHSL key once again to “re-arm” the trigger.
- 6 After nine seconds, the message changes from `Sync RHSL`, and the sampled data loops in a four-second loop. The display shows `Sync 0:0X`, where X is the current second of the loop.
- 7 Stop the source.
- 8 Turn the MULTI DIAL control (11) to adjust the point of the loop. The display shows:  
`TRIM = +XXXXf` or  
`TRIM = -XXXXf`, where XXX can be a number between 0 and 125 and changes back to the `Sync 0:0X` display when the loop restarts.
- 9 Every time the trim value is changed, the loop starts replaying from the new start point.
- 9 When the new start point has been set, press the STOP key (16 or 18).
- 10 Cue up the source material to the original point set in step 2.
- 11 Press the RECORD key (19 or 13) to enter record ready mode, and then press the SYNC REC key (20 or 14).
- 12 Start playing the source material. The unit starts recording, with the start point being determined by the trim value.

#### NOTE

If a trim setting is made for the sync start, this will apply to all sync starts and track divisions made in the future until the value is reset using the procedure above.

### 4.5.2 Rehearsal for track division

In the same way that the automatic threshold may produce a false trigger, starting recording at the wrong point, the automatic threshold may produce false track divisions.

By rehearsing the point at which the track division is to be made, it is possible to trim the division point so that it corresponds to a the track division which is actually required.

- 1 Load a recordable disc into the unit and make sure the unit is in stop mode.
- 2 If the unit is not already in auto track mode, set it so that the A-TRACK indicator is lit on the display (4.3.2, “Automatic track division”).
- 3 Cue the source material to a little before the point of the planned track division.
- 4 Press the RHSL key (4) twice so that the display shows `Waiting Inc.`  
If the auto track mode has not previously been selected, the display shows `No Inc Mode` when the key is pressed.
- 5 Start playing the source. When the start of the track is detected (as explained in 4.3.1, “Synchronized recording”), the display changes to `Inc RHSL`.
- 6 If the rehearsal does not start at the region of the true track division point, press the RHSL key once again to “re-arm” the trigger.
- 7 After nine seconds, the message changes from `Inc RHSL`, and the sampled data loops in a four-second loop. The display shows `Inc 0:0X`, where X is the current second of the loop.
- 8 Stop the source.

- 9 Turn the MULTI DIAL control (11) to adjust the point of the loop. The display shows:  
`TRIM = +XXXXf` or  
`TRIM = -XXXXf`, where XXXX can be a number between 0 and 125 and changes back to the `Inc 0:0X` display when the loop restarts.

- 10 When the track division point has been fixed, press the STOP key (16) or (18).
- 11 Press the RECORD key (19) or (13) to enter record ready mode. The synchronized recording mode can be used here, and so the SYNC REC key (20) or (14) may be pressed to prepare for synchronized recording.
- 12 Cue up the source material to the point where recording is to start.
- 13 Start playing the source material. If sync recording is not being used, start recording on the CD-RW2000 (otherwise recording starts automatically).

When the track division point (plus or minus the trim value set earlier) is reached, the recording will divide into tracks.

Note that if a positive trim value is set (i.e. the start point of the track is “slipped” to a position past the “normal” start), the counter shows a minus value (e.g. `-0.02`) for the period between the “normal” and the actual adjusted start position. This minus value is also displayed when recording starts, if sync recording has been enabled.

#### NOTE

*If a trim setting is made for the track division, this will apply to all track divisions and sync starts made in the future until the value is reset using the procedure above.*

## 5 – After recording

This section deals with the actions taken after recording: finalizing for CD-R and CD-RW discs, and erase operations for CD-RW discs.

Once finalized, CD-R discs are truly final—no more can be recorded on them. By contrast, CD-RW discs can be “unfinalized” using the CD-RW2000, i.e. their TOC can be deleted, and if there is space, further material can be recorded on them. Even if the disc is full, tracks can be erased following the unfinalize process, and new material can be recorded.

---

### 5.1 Finalizing

---

As has been explained earlier (1.2, “Finalizing”), in order for a disc to become a standard CD, it must have a Table of Contents (TOC) written to it. This process is known as finalizing.

An unfinalized disc can always be distinguished on the CD-RW2000 by the NO TOC indicator under the disc type on the display being lit when the disc is inserted.

To finalize a disc:

- 1 **With the unfinalized (recordable) disc loaded, and the unit in stop mode, press the FINALIZE key (14 or 11).**  
**The display shows `Finalize OK?`.**
- 2 **If you do not want to proceed with the finalizing process, press any other key (such as the STOP key).**
- 3 **To start the finalizing process, press the MULTI DIAL control (11) or press the ENTER key (7).**
- 4 **If finalization has been chosen, the display changes. The NO TOC indicator goes out, and the word TOC and the REC indicator flashes in the display. The unit starts counting down from a time shown on the display (about 1 minute 10 seconds).**
- 5 **After finalization, a CD-RW NO TOC changes to CD-RW and a CD-R NO TOC changes to a CD.**

#### NOTE

*Although CD-R discs finalized on the CD-RW2000 may be replayed on ordinary CD players, remember that finalized CD-RW discs may not play on CD players.*

#### 5.1.1 Unfinalizing CD-RW discs

If a CD-RW disc has been finalized, it is possible to erase the Table of Contents in the following way:

- 1 **With the finalized disc loaded and the unit in stop mode, press the ERASE key (15 or 12).**
- 2 **If the display does not show the word `Unfinalize?`, turn the MULTI DIAL control (11) or use the SKIP keys (17) until it is displayed.**
- 3 **If you do not want to proceed with the unfinalizing process, press any other key (such as the STOP key).**
- 4 **To start the unfinalizing process, press the MULTI DIAL control (11) or press the ENTER key (7).**
- 5 **If unfinalization has been chosen, the NO TOC indicator starts flashing in the display, and the word ERASE also starts flashing. The unit starts counting down from a time shown on the display (depending on the disc and material, this value will be between 50 seconds and 1 minute 30 seconds).**
- 6 **After unfinalization, a CD-RW indicator changes to a CD-RW NO TOC indicator.**

---

### 5.2 Erasing

---

Unfinalizing (described above) is a special case of erasing a disc. It is also possible to erase a track or tracks, starting with the last-recorded track, a whole disc, or to “refresh” a disc.

#### NOTE

*Erase procedures are possible only on a CD-RW disc. Even if a CD-RW disc has been finalized, selecting an erase procedure will automatically unfinalize it prior to erasure. The disc may then have to be re-finalized. Remember that it is not possible to perform any erase procedures on a CD-R disc.*

#### 5.2.1 Erasing tracks

It is possible to erase the last recorded track, the last two recorded tracks, the last three recorded tracks, etc. It is not, however, possible to erase tracks in the “middle” of the disc.

- 1 **With the disc loaded, and the unit in stop mode, press the ERASE key (15 or 12).**
- 2 **If the display does not show `ERASE XX-XX?`, where XX is the number of the last track recorded on the disc, turn the MULTI DIAL control (11) or use the SKIP keys (17) until it is displayed.**

- 3 Turn the MULTI DIAL control or use the SKIP keys to change the number of the first track to be erased. The highest value that this number can take is the last track recorded (e.g. if 17 tracks have been recorded on the disc, 17–17 means that the last track only, 17, will be erased). The lowest value that this number can take is 2 (if this number was 1, the whole disc would be erased, as described below).
- 4 If you do not want to proceed with the erase operation, press any other key (such as the STOP key).

### NOTE

If only one track has been recorded on the disc, only the “erase disc” option (5.2.2, “Erasing a whole disc”) is available.

- 5 When the range of tracks to be erased has been selected, press the MULTI DIAL control or press the ENTER key 7.

### NOTE

This operation cannot be undone. If you are going to erase a track or tracks, make sure that they are recordings that you really want to erase!

- 6 If the erase operation has been selected, the word ERASE flashes on the display, and the timer starts counting down. The process will typically take around 20 seconds).
- 7 At the end of the countdown period, the word Complete appears briefly on the display, and the display returns to the track/time display.

### 5.2.2 Erasing a whole disc

When you want to erase a whole disc (all the tracks on a disc), follow the procedure below:

- 1 With the disc loaded, and the unit in stop mode, press the ERASE key (15 or 12).
- 2 Turn the MULTI DIAL control 11 or use the SKIP keys 17 until the display shows ERASE DISC?.
- 3 If you do not want to proceed with the erase operation, press any other key (such as the STOP key).
- 4 To erase the contents of the disc, press the MULTI DIAL control or press the ENTER key 7.

### NOTE

This operation cannot be undone. If you are going to erase a disc, make sure that it contains only recordings that you really want to erase!

- 5 If the erase operation has been selected, the word ERASE flashes on the display, and the timer starts counting down a time value shown on the display.
- 6 At the end of the countdown period, the word Complete appears briefly on the display, and the display returns to the track/time display.

### 5.2.3 Refreshing a disc

If a CD-RW disc has been corrupted at any point (e.g. power has been cut off in the middle of a finalize operation, etc.), or has been used in a computer or another piece of equipment that makes it unreadable, it is possible to “refresh” the disc to make it usable again. This is equivalent to formatting a disk on a computer to prepare it for use. This operation destroys all data on the disc.

- 1 With the disc loaded, and the unit in stop mode, press the ERASE key (15 or 12).
- 2 Turn the MULTI DIAL control 11 or use the SKIP keys 17 until the display shows DISC REFRESH.
- 3 If you do not want to proceed with the refresh operation, press any other key (such as the STOP key).
- 4 To refresh the disc, press the MULTI DIAL control or press the ENTER key 7.

### NOTE

This operation cannot be undone. If you are going to refresh a disc, make sure that it contains only recordings that you really want to erase!

- 5 If the refresh operation has been selected, the words ERASE XX:XX are shown on the display, and the timer starts counting down (XX:XX). The refresh operation typically takes around 20 minutes.
- 6 At the end of the countdown period, the word Complete appears briefly on the display, and the display returns to the track/time display (of course, there are no tracks, and the disc is as the start, with the total time of the disc available for recording).

## 6 – Reference and specifications

### 6.1 Troubleshooting

Symptom	Possible cause and remedy
No sound on playback (the disc is playing and the time display is incrementing)	The connections from the CD-RW2000 to the amplifier system have not been made properly, or the input source selector is not at the correct position.
No meter indication when a source is input	Analog and/or digital volume (4.1.1, "Signal volume") is set too low. The signal is being input through an unselected input source (4.1, "Input selection").
D-IN UNLOCK!	A digital input source has been selected, but the source is not connected or is not switched on.
Cannot record on a disc (pressing <b>RECORD</b> shows <b>MONITOR</b> )	A finalized disc has been inserted. Use an unfinalized recordable disc.
The recording level suddenly jumps (up or down) when switching to or from digital direct mode	When recording from digital sources, the digital direct mode bypasses the digital level (4.1.1, "Signal volume"), so that if this has been set to a non-zero value, the level will be different. See 4.3.3, "Digital direct".
PGM Full !	An attempt has been made to create more than 25 program steps.
Disc Full! or Cannot Rec!	There is no space on the disc, or no tracks are available, or a general recording error has occurred.
Word CLK Err	An external word sync clock has been selected (see 2.4.1, "Word sync connections"), but no word clock source is available or the word clock is $\pm 7\%$ or more away from the base frequency of 44.1 kHz.
Not FS 44.1k!	You are trying to do digital direct recording from a source which has not been recorded at 44.1 kHz (4.3.3, "Digital direct").
No Inc Mode	Auto track is not on when an attempt is being made to rehearse track split times.
Disc Error	The disc is bad. If it is a CD-RW disc, you may refresh it (5.2.3, "Refreshing a disc"), otherwise replace the disc.
Erase Error!	An error has occurred while trying to erase the disc.
The display suddenly shows <b>PMA Writing</b>	Either the disc is full (this message will be prefaced by <b>Disc Full!!!</b> (4.2.5, "Full disc") or an attempt has been made to write more than 99 tracks.

Symptom	Possible cause and remedy
Rec Error	General recording error. This may be caused by vibration or a shock during recording, for example, or may be the result of a bad disc. Try recording again with the same disc. If the message appears again, try a different disc.
No OPC Area!	Appears only with CD-R discs. The OPC area is full, and no further recording is possible on this disc. Finalize the disc.
OPC Area CLR	Seen when a CD-RW disc OPC area is full, and the CD-RW2000 automatically cleans up the OPC area for further recording.
Need Repair!	Current disc needs repair. Refresh the CD-RW disc using the procedure described in 5.2.3, "Refreshing a disc".
System Err!	System error.
Tray Error!	Error in the tray mechanism.
Drive Error!	Error in the drive mechanism.

### 6.2 Specifications

Recording media type	CD-R, CD-RW, CD-RDA, CD-RWDA
Recording resolution	16-bit linear
Recording sampling frequency	44.1 kHz
Frequency convertor input	32 kHz — 48 kHz
Frequency response	20 Hz — 20 kHz (playback $\pm 0.5$ dB, recording $\pm 1$ dB)
S/N ratio	> 98 dB (playback) > 92 dB (recording)
Dynamic range	> 94 dB (playback) > 92 dB (recording)
Total harmonic distortion	< 0.004% (playback) < 0.005% (recording)
Channel separation	90 dB (playback : 1 kHz) 80 dB (recording : 1 kHz)
Wow & flutter	Unmeasurable (< 0.001%)
Analog inputs	Balanced XLR-type
Nominal input level	+4 dBu
Maximum input level	+20 dBV
Input impedance	10 k $\Omega$ (balanced)
Analog inputs	Unbalanced RCA
Nominal input level	-10 dBV (FS -16 dB)
Maximum input level	+6 dBV
Input impedance	33 k $\Omega$ (unbalanced)
Analog outputs	Unbalanced RCA
Nominal output level	-10 dBV (FS -16 dB)
Maximum output level	+6 dBV
Output impedance	800 $\Omega$ (unbalanced)

## 6 – Reference and specifications—Specifications

Analog outputs	Balanced XLR-type
Nominal output level	+4 dBu (FS –16 dB)
Maximum output level	+20 dBu
Output impedance	75 $\Omega$ (balanced)
Headphone output	6 mm (1/4") stereo
Output level	35 mW + 35 mW (into 32 $\Omega$ )
Digital inputs	
AES/EBU	XLR-type, AES3-1992
COAXIAL	RCA pin, IEC60958 TYPE II
OPTICAL	TOSLINK , IEC60958 TYPE II
Digital outputs	
AES/EBU	XLR-type, AES3-1992
COAXIAL	RCA pin, IEC60958 TYPE II
OPTICAL	TOSLINK , IEC60958 TYPE II

Voltage requirements	USA/Canada 120 VAC, 60 Hz U.K./Europe 230 VAC, 50 Hz Australia 240 VAC, 50 Hz General export 120/230 VAC, 60 Hz
Power consumption	30 W
Applicable electromagnetic environment	E4
Peak inrush current	1.8 A
Dimensions	483 x 98 x 317.5 (mm) 19 x 3.9 x 12.5 (in)
Weight	7 kg (15.4 lbs)
Operating temperature	5°C to 35°C (41°F to 95°F)
Supplied accessories	RC-RW2000 remote control unit 2m (6 ft.) AC cord Rack mount screw kit

# TASCAM

TEAC Professional Division

# CD-RW2000

## TEAC CORPORATION

Phone: (0422) 52-5082

3-7-3, Nakacho, Musashino-shi, Tokyo 180-8550, Japan

## TEAC AMERICA, INC.

Phone: (323) 726-0303

7733 Telegraph Road, Montebello, California 90640

## TEAC CANADA LTD.

Phone: 905-890-8008 Facsimile: 905-890-9888

5939 Wallace Street, Mississauga, Ontario L4Z 1Z8, Canada

## TEAC MEXICO, S.A. De C.V

Phone: 5-658-1943

Privada De Corina, No.18, Colonia Del Carmen Coyoacan, Mexico DF 04100

## TEAC UK LIMITED

Phone: 01923-819699

5 Marlin House, Marlin Meadow, The Croxley Centre, Watford, Herts. WD1 8YA, U.K.

## TEAC DEUTSCHLAND GmbH

Phone: 0611-71580

Bahnstrasse 12, 65205 Wiesbaden-Erbenheim, Germany

## TEAC FRANCE S. A.

Phone: 01.42.37.01.02

17 Rue Alexis-de-Tocqueville, CE 005 92182 Antony Cedex, France

## TEAC BELGIUM NV/SA

Phone: 0162-510860

Oeverkruid 15, NL-4941 VV Raamsdonksveer, Netherlands

## TEAC NEDERLAND BV

Phone: 0162-510210

Oeverkruid 15, NL-4941 VV Raamsdonksveer, Netherlands

## TEAC AUSTRALIA PTY.,LTD. A.C.N. 005 408 462

Phone: (03) 9644-2442

106 Bay Street, Port Melbourne, Victoria 3207, Australia

## TEAC ITALIANA S.p.A.

Phone: 02-66010500

Via C. Cantù 11, 20092 Cinisello Balsamo, Milano, Italy