

TASCAM

TEAC Professional Division

D00945120A

CD-160MKII

Compact Disc Player

OWNER'S MANUAL

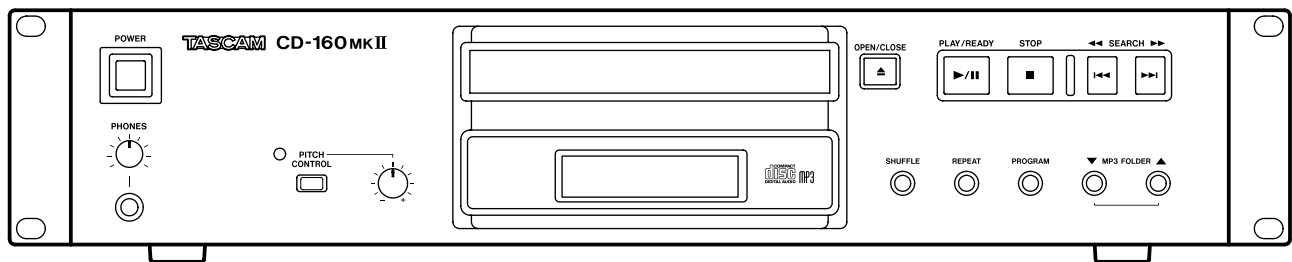

IMPORTANT SAFETY PRECAUTIONS



CAUTION
RISK OF ELECTRIC SHOCK
DO NOT OPEN



CAUTION: TO REDUCE THE RISK OF ELECTRIC SHOCK, DO NOT REMOVE COVER (OR BACK). NO USER-SERVICEABLE PARTS INSIDE. REFER SERVICING TO QUALIFIED SERVICE PERSONNEL.



The lightning flash with arrowhead symbol, within equilateral triangle, is intended to alert the user to the presence of uninsulated "dangerous voltage" within the product's enclosure that may be of sufficient magnitude to constitute a risk of electric shock to persons.



The exclamation point within an equilateral triangle is intended to alert the user to the presence of important operating and maintenance (servicing) instructions in the literature accompanying the appliance.

This appliance has a serial number located on the rear panel. Please record the model number and serial number and retain them for your records.

Model number _____

Serial number _____

WARNING: TO PREVENT FIRE OR SHOCK HAZARD, DO NOT EXPOSE THIS APPLIANCE TO RAIN OR MOISTURE.

For U.S.A.

TO THE USER

This equipment has been tested and found to comply with the limits for a Class A digital device, pursuant to Part 15 of the FCC Rules. These limits are designed to provide reasonable protection against harmful interference when the equipment is operated in a commercial environment. This equipment generates, uses, and can radiate radio frequency energy and, if not installed and used in accordance with the instruction manual, may cause harmful interference to radio communications.

Operation of this equipment in a residential area is likely to cause harmful interference in which case the user will be required to correct the interference at his own expense.

CAUTION

Changes or modifications to this equipment not expressly approved by TEAC CORPORATION for compliance could void the user's authority to operate this equipment.

For the customers in Europe

WARNING

This is a Class A product. In a domestic environment, this product may cause radio interference in which case the user may be required to take adequate measures.

Pour les utilisateurs en Europe

AVERTISSEMENT

Il s'agit d'un produit de Classe A. Dans un environnement domestique, cet appareil peut provoquer des interférences radio, dans ce cas l'utilisateur peut être amené à prendre des mesures appropriées.

Für Kunden in Europa

Warnung

Dies ist eine Einrichtung, welche die Funk-Entstörung nach Klasse A besitzt. Diese Einrichtung kann im Wohnbereich Funkstörungen verursachen; in diesem Fall kann vom Betreiber verlangt werden, angemessene Maßnahmen durchzuführen und dafür aufzukommen.

CE Marking Information

- a) Applicable electromagnetic environment: E4
- b) Peak inrush current: 0.6 A

In North America use only on 120V supply.

IMPORTANT SAFETY INSTRUCTIONS

- 1 Read these instructions.
 - 2 Keep these instructions.
 - 3 Heed all warnings.
 - 4 Follow all instructions.
 - 5 Do not use this apparatus near water.
 - 6 Clean only with dry cloth.
 - 7 Do not block any ventilation openings. Install in accordance with the manufacturer's instructions.
 - 8 Do not install near any heat sources such as radiators, heat registers, stoves, or other apparatus (including amplifiers) that produce heat.
 - 9 Do not defeat the safety purpose of the polarized or grounding-type plug. A polarized plug has two blades with one wider than the other. A grounding type plug has two blades and a third grounding prong. The wide blade or the third prong are provided for your safety. If the provided plug does not fit into your outlet, consult an electrician for replacement of the obsolete outlet.
 - 10 Protect the power cord from being walked on or pinched particularly at plugs, convenience receptacles, and the point where they exit from the apparatus.
 - 11 Only use attachments/accessories specified by the manufacturer.
 - 12 Use only with the cart, stand, tripod, bracket, or table specified by the manufacturer, or sold with the apparatus. When a cart is used, use caution when moving the cart/apparatus combination to avoid injury from tip-over.
- Do not expose this apparatus to drips or splashes.
 - Do not place any objects filled with liquids, such as vases, on the apparatus.
 - Do not install this apparatus in a confined space such as a book case or similar unit.
 - The apparatus draws nominal non-operating power from the AC outlet with its POWER switch in the off position.
 - The apparatus should be located close enough to the AC outlet so that you can easily grasp the power cord plug at any time.
 - An apparatus with Class I construction shall be connected to an AC outlet with a protective grounding connection.
 - Batteries (battery pack or batteries installed) should not be exposed to excessive heat such as sunshine, fire or the like.



- 13 Unplug this apparatus during lightning storms or when unused for long periods of time.
- 14 Refer all servicing to qualified service personnel. Servicing is required when the apparatus has been damaged in any way, such as power-supply cord or plug is damaged, liquid has been spilled or objects have fallen into the apparatus, the apparatus has been exposed to rain or moisture, does not operate normally, or has been dropped.

Safety Information

This product has been designed and manufactured according to FDA regulations “title 21, CFR, chapter 1, subchapter J, based on the Radiation Control for Health and Safety Act of 1968,” and is classified as a class 1 laser product. There is no hazardous invisible laser radiation during operation because invisible laser radiation emitted inside of this product is completely confined in the protective housings.

The label required in this regulation is shown at ①.

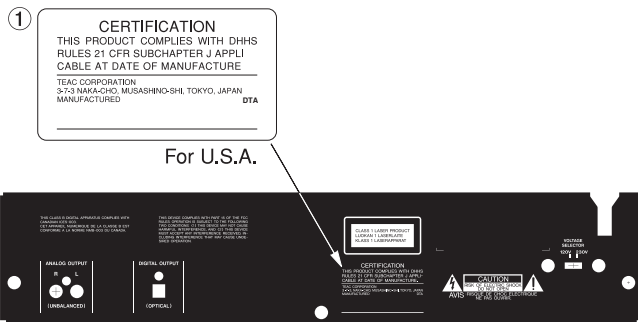

CAUTION

- DO NOT REMOVE THE PROTECTIVE HOUSING USING A SCREWDRIVER.
- USE OF CONTROLS OR ADJUSTMENTS OR PERFORMANCE OF PROCEDURES OTHER THAN THOSE SPECIFIED HEREIN MAY RESULT IN HAZARDOUS RADIATION EXPOSURE.
- IF THIS PRODUCT DEVELOPS TROUBLE, CONTACT YOUR NEAREST QUALIFIED SERVICE PERSONNEL, AND DO NOT USE THE PRODUCT IN ITS DAMAGED STATE.

Optical pickup:

Type : KSS-213CL
Manufacturer : SONY Corporation
Laser output : Less than 0.4 mW on the objective lens
Wavelength : 760 to 800 nm

1 – Introduction	6	Repeat Playback.....	19
Supplied accessories.....	6	Repeat one track (REPEAT).....	19
Rack-mounting the unit	6	Repeat all the tracks (REPEAT ALL).....	19
About this manual.....	6	Repeat all the tracks in the folder (REPEAT ALBUM) (MP3 only).....	19
Precautions and notes for placement and use	6	Shuffle Playback	19
Beware of condensation.....	7	Intro Check.....	19
Never use a stabilizer or printable discs	7	Search Mode (MP3 only)	20
About discs.....	7	Search for a name of track.....	20
Handling of compact discs.....	8	Search for a track in a folder	21
Use of the remote control unit.....	8	4 – Reference and specifications	22
Batteries	9	Troubleshooting.....	22
Inserting batteries	9	No power	22
Connections	9	Remote control doesn't work.....	22
2 – Features of the CD-160MKII.....	10	No sound.....	22
Front panel and RC-162C remote control unit.....	10	Will not play.	22
Rear panel	11	Sound skips.	22
Display	12	Maintenance.....	22
3 – Disc operations	13	Specifications.....	23
MP3 files and directories	13	Dimensions.....	23
Listening to CD/MP3 (1).....	14		
To suspend playback temporarily (pause mode).....	15		
To stop playbacks.....	15		
Search for a part of a track	15		
To skip to the next or a previous track	15		
Direct Playback.....	15		
Pitch control	15		
Listening to CD/MP3 (2).....	15		
Listening through headphones	16		
To display the MP3 information	16		
Skip to the next folder (MP3)	16		
Programmed Playback.....	17		
To check the programmed order	18		
To add a track to the end of the program	18		
To overwrite the program.....	18		
To clear program	18		

1 – Introduction

Thank you for your purchase of the TASCAM CD-160MKII Compact Disc Player.

After you have finished reading this manual, please keep it in a safe place for future reference.

Before connecting and using the unit, please take time to read this manual thoroughly to ensure you understand how to properly set up and connect the unit, as well as the operation of its many useful and convenient functions.

Supplied accessories

In addition to this manual, the CD-160MKII has been packed with the following:

Contact your TASCAM supplier if any of these items are missing.

- RC-162C remote control unit 1
- A rack-mounting screw kit (screws and washers) 1
- AAA batteries for the remote control unit 2
- A warranty card 1

Rack-mounting the unit

If you are mounting the unit in a rack, leave 1U of space above it and 4 inch (10 cm) or more of space at the rear.

Use the rack-mounting kit to mount the unit in a standard 19-inch equipment rack, as shown in this section. Remove the feet of the unit before mounting.

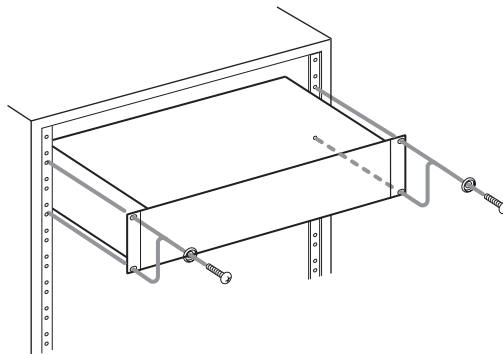

About this manual

In this manual, we use the following conventions:

- The names of keys and controls are given in the following typeface: **PROGRAM**.
- When the alphanumeric portion of the display shows a message, this is shown in the following typeface: **NONE**.
- If a preset indicator in the display (i.e. one which cannot change) is shown, this is shown as follows: **EPS**.

Precautions and notes for placement and use

The CD-160MKII may be used in most areas, but to maintain top performance, and prolong operating life, observe the following notes, precautions and environmental conditions:

- Avoid exposing it to extremes of temperature and humidity and avoid mechanical shocks and vibration.
- Keep the unit away from strong magnetic fields (TV sets, computer monitors, large electric motors, etc.).
- The nominal temperature should be between 5°C and 35°C (41°F and 95°F).
- Relative humidity should be 30 to 90 percent.
- As the unit may become hot during operation, always leave sufficient space above the unit for ventilation. Do not install this unit in a confined space such as a bookcase, and do not put anything on top of the unit.
- Avoid installing this unit on top of any heat-generating electrical device such as a power amplifier.
- Make sure that the unit is mounted in a level position for correct operation.

1 – Introduction

- Do not open the sealed cabinet as this might result in damage to the circuitry or electrical shocks. If a foreign object should get inside the unit, contact your supplier or service agency.
- When removing the power plug from the wall outlet, always pull directly on the plug, never yank the cord.
- To keep the laser pickup clean, do not touch it and always close the disc tray.
- As the disc rotates at high speed during playback, do not lift or move the unit. Doing so may damage the disc or the laser assembly.
- The voltage selector on the rear panel is only available on units for the North American market. Please set this

to match your local supply. If you are in any doubt in this matter, consult an electrician.

NOTE

When transporting the unit, always use the original packing materials. For this reason, we strongly recommend that you save all the packing materials that came with the CD-160MKII, in case you need to transport it in the future.

In addition, when transporting the unit, you should tape the disc tray closed, using an adhesive tape that will not spoil the finish of the unit.

Beware of condensation

If the unit (or a compact disc) is moved from a cold to a warm place, or used after a sudden temperature change, there is a danger of condensation; vapor in the air could condense on the internal mechanism, making correct oper-

ation impossible. To prevent this, or if this occurs, let the player sit for one or two hours at the new room temperature before using.

Never use a stabilizer or printable discs

Using commercially available CD stabilizers or printable recordable discs with this player will damage the mechanism and cause it to malfunction.

NOTE

Never use a disc that has had a stabilizer mounted to it. The residual adhesive may cause the disc to stick to the turntable of the CD-160MKII. If it sticks to the turntable, you will need a technician to get it out.

About discs

- Conventional audio CDs bearing the COMPACT DISC DIGITAL AUDIO logo on the label:



- Properly finalized CD-R and CD-RW discs.

NOTE

Depending on the quality of the disc and/or the condition of the recording, some CD-R/CD-RW discs may not be playable.

Copy-protected discs and other discs that do not conform to the CD standard may not play back correctly in this player. If you use such discs in this unit, TEAC Corporation and its subsidiaries cannot be responsible for any consequences or guarantee the quality of reproduction. If you experience problems with such non-standard discs, you should contact the producers of the disc.

1 – Introduction

Handling of compact discs

The CD-160MKII has been designed for the playback of CD-DA (standard audio) format discs and MP3 files recorded on the discs using the ISO9660 format: In addition to ordinary 5-inch and 3-inch CDs.

- Always place the compact discs in the trays with their label facing upward.
- To remove a disc from its case, press down on the center of the disc holder, then lift the disc out, holding it carefully by the edges.

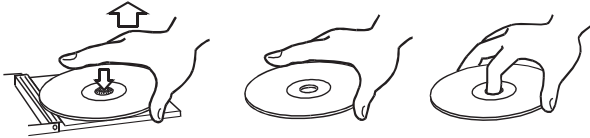

- Do not use any record spray, anti-static solutions, benzene, paint thinner or other chemical agents to clean CDs as they could damage the delicate playing surface. It may cause CDs to become unplayable.
- Discs should be returned to their cases after use to avoid dirt as well as serious scratches that could cause the laser pickup to “skip.”
- Avoid getting fingerprints on the signal side (the non-label side). Grime and dust may cause skipping, so keep discs clean and store them in their cases when not being played. To clean the signal side of a disc, wipe gently with a soft dry cloth from the center towards the outside edge.



- Keep discs away from direct sunlight, and places of high heat and humidity. If left in such places, warping could result.
- Do not affix any labels or stickers to the label side of the disc and do not use any protective coating spray.

- Do not insert discs that have adhesive remaining from tape or stickers that have been removed. If they are inserted into the player, they could stick to the internal mechanism, requiring removal by a technician.
- Do not use cracked discs.
- Only use circular compact discs. Avoid using non-circular promotional, etc. discs.

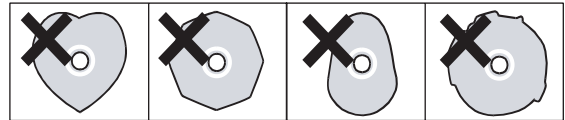

- The CD-160MKII cannot play unfinalized CD-R/RW discs.
- CD-R and CD-RW discs are sensitive to the effects of heat and ultraviolet rays. It is important that they are not stored in a location where direct sunlight will fall on them, and which is away from sources of heat such as radiators or heat-generating electrical devices.
- When labeling CD-R and CD-RW discs, always use a soft oil-based felt-tipped pen to write the information. Never use a ball-point or hard-tipped pen, as this may cause damage to the recorded side.
- If you are in any doubt as to the care and handling of a CD-R and CD-RW discs, read the precautions supplied with the disc, or contact the disc manufacturer directly.
- Music discs with copy control, a copy-protection system, have been released from several record companies in an attempt to protect the copyright. Since some of these discs do not comply with the CD specifications, they may not be playable on the CD-160MKII.

Use of the remote control unit

- Do not expose the infrared receiver (light receptive area on the front panel) to direct sunlight or intense light for extended periods of time. Long exposure to this light may result in failure of the remote control sensor.
- When the remote control will not be used over one month, please remove the batteries to prevent the possibility of battery acid leakage which could damage the unit. Should leakage occur, remove and discard the batteries, and wipe the battery case thoroughly with a cloth. Avoid getting the battery liquid on the skin. After cleaning, replace with new batteries.
- The remote control functions by using an infrared light signal. When using the unit to control the CD-160MKII,

other devices that are turned on could be operated by its signal.

- If the range of remote operation becomes smaller, or commands do not always function properly, the batteries have become weak and should be replaced. Always replace both batteries with new batteries of the same type.
- Point the remote control to the remote sensor on the main unit. Do not obstruct the path between the remote control and the remote sensor.

1 – Introduction

Batteries

If batteries are used improperly, or if leakage or breakage occurs, the unit will not function.

Please observe the cautions indicated on the batteries and their packaging to ensure proper usage.

- Confirm + and – polarity and follow the indications when inserting new batteries into the remote control.
- Do not use old and new batteries together.
- Even if the battery is the same size, the voltage may differ. Do not use batteries of different specifications together.
- Do not attempt to recharge batteries that are non-rechargeable.
- Do not open or disassemble batteries, throw them into a fire or put them in water.

■ Inserting batteries

1. Open the lid.
2. Confirm +/- polarity, and insert two AAA batteries.
3. Close the lid.

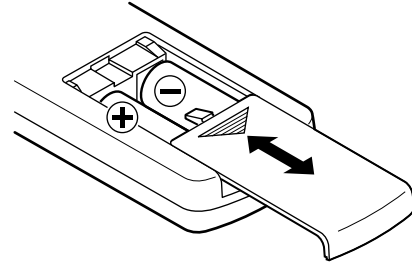

Connections

CAUTION

Turn off the power of all the equipment before making connections.

Read instructions of each component you intend to use with this unit.

Be sure to insert each plug securely. To prevent hum and noise, do not bundle the connection cords with the power cord.

Connect **ANALOG OUTs (L,R)** jacks to the input jack of the amplifier with a RCA cable. Make sure to connect:

- white plug → white jack (L: left channel)
- red plug → red jack (R: right channel)

Use an optical cable to output the signal from the **DIGITAL OPTICAL OUT** to the amplifier or recorder's input.

Use a RCA cable to output the signal from the **DIGITAL COAXIAL OUT** to the amplifier or recorder's input.

After all other connections are complete, connect the plug to the AC wall socket.

NOTE

Before making a recording with a recorder connected to this unit's digital outputs, you need to standby this unit in playback mode.

Be sure to connect the power cord to an AC outlet which supplies the correct voltage. Hold the power plug when plugging or unplugging the power cord. Never pull or yank on the power cord.

The Digital output on the CD-160MkII does not include track increment data. Some recorders depend on this information to automatically update track numbers while dubbing. If you need this function, please connect the CD-160MkII and the recording device with the analog connections and use "level detection" mode on the recorder to detect track changes (please refer to the manual of the recorder for how to select this mode).

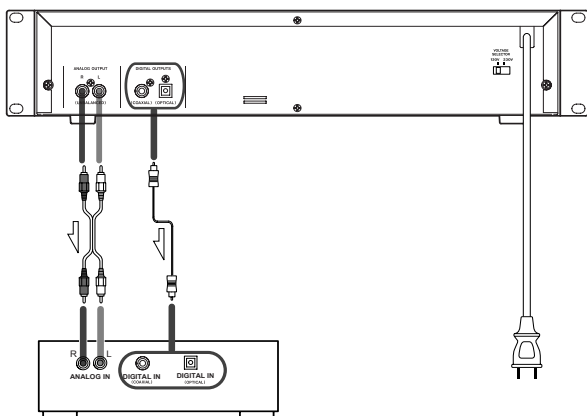

2 – Features of the CD-160MKII

Front panel and RC-162C remote control unit

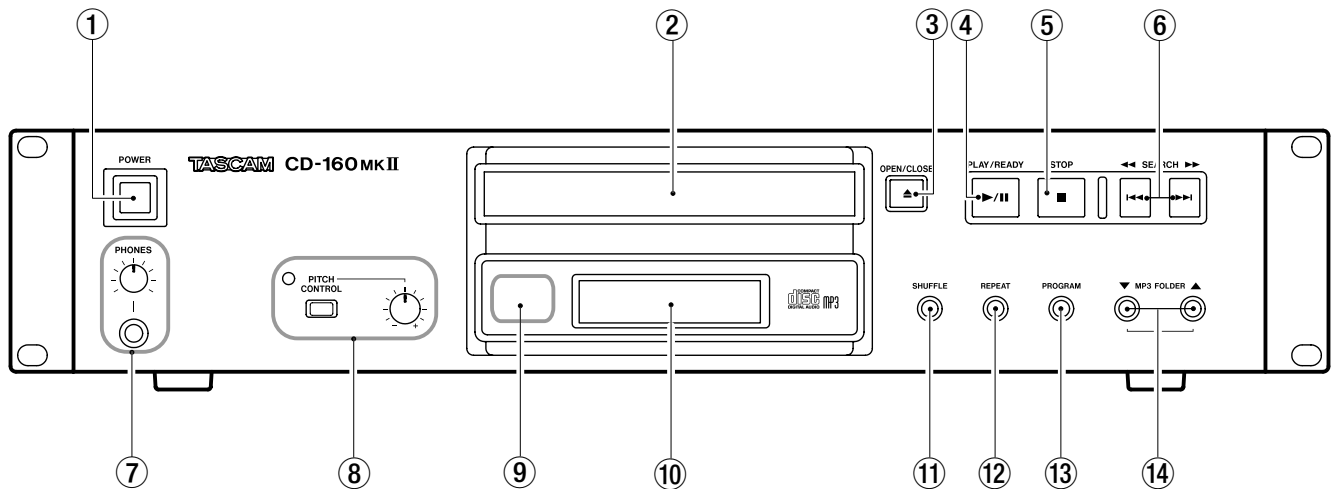

RC-162C remote control unit

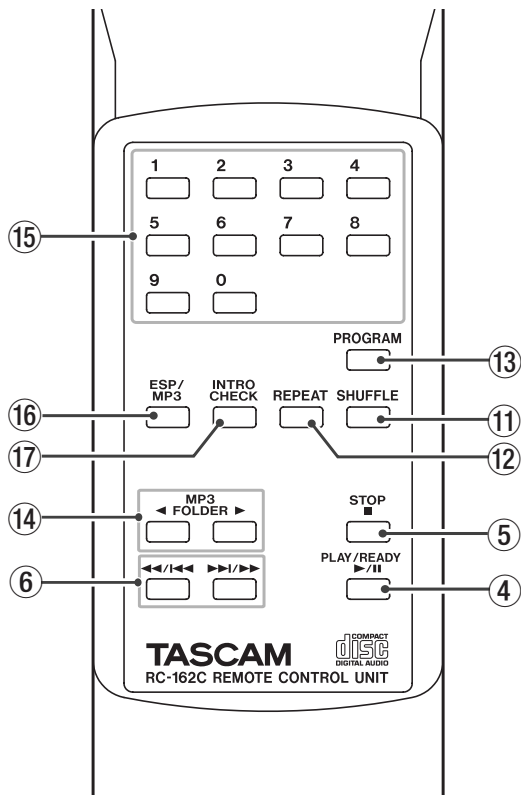

- ① **POWER**
Press this switch to turn the unit on or off.
- ② **Disc tray**
- ③ **OPEN/CLOSE**
Use this key to open and close the disc tray.
- ④ **PLAY/READY (▶/||)**
Use this key to start or pause playback of CD/MP3.
- ⑤ **STOP (■)**
Use this key to stop playback of CD/MP3.
- ⑥ **SEARCH (◀◀/▶▶) / ◀◀/▶▶ (SKIP)**
Use these keys to skip tracks. Hold down these keys to search for a part of a track.

- ⑦ **PHONES jack and knob**
For private listening, insert the headphones plug into this jack, and adjust the volume by turning the level knob.
- ⑧ **PITCH CONTROL switch and knob**
Use this switch to turn the pitch control function on or off. When the function is on, the LED will light. Adjust the amount by turning the knob.
- ⑨ **Remote Sensor**
When operating the remote control unit, point it towards here.
- ⑩ **Display**
- ⑪ **SHUFFLE**
Use this key for shuffle playback.
- ⑫ **REPEAT**
Use this key for repeat playback.
- ⑬ **PROGRAM**
Use this key to program tracks.
- ⑭ **MP3 FOLDER (▲/▼)**
During playback of a MP3 disc, use these keys to select a folder in the disc.
- ⑮ **Numeric keys (remote control only)**
Use these keys to select tracks.
- ⑯ **ESP/MP3 (remote control only)**
During playback of a MP3 disc, use this key to search track name. During playback of CD, use this key to switch the ESP function on or off. The default setting is off.
- ⑰ **INTRO CHECK (remote control only)**
Use this key to start the Intro Check.

NOTE

To simplify explanations, instructions in this manual refer to the names of the keys and controls on the front panel only. Associated controls on the remote control will also operate similarly.

2 – Features of the CD-160MKII

Rear panel

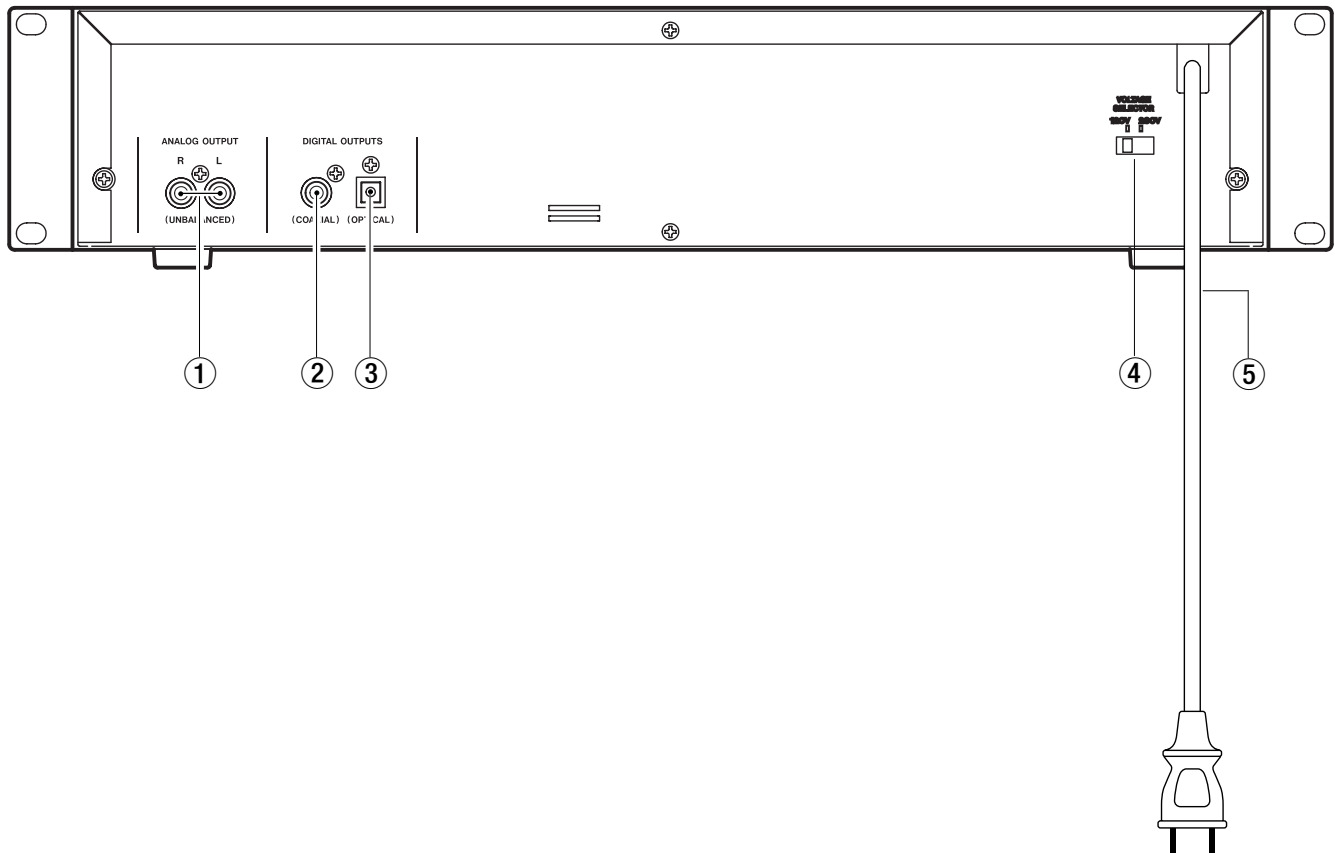

- ① **ANALOG OUTPUT L,R jacks (UNBALANCED)**
Analog 2-channel audio signal is output from this jack.
- ② **DIGITAL COAXIAL OUTPUT jack**
This RCA jack output SPDIF digital audio data to the amplifier.

NOTE

This unit cannot output the digital audio data when Pitch Control is ON, and ESP is ON during playback of a CD.

- ③ **DIGITAL OPTICAL OUTPUT jack**
This compatible connector output S/PDIF digital audio data to the amplifier.

NOTE

This unit cannot output the digital audio data when Pitch Control is ON, and also ESP is ON during playback of a CD.

- ④ **VOLTAGE SELECTOR**
Switches the voltage to either 230 V or 120 V.

NOTE

The voltage selector is only available on units for North American market.

- ⑤ **AC Power Cord**
After all other connections are complete, connect the plug to the AC wall socket.

2 – Features of the CD-160MKII

Display

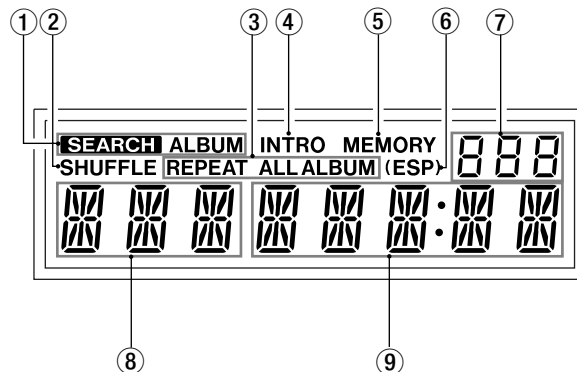

- ① **SEARCH / SEARCH ALBUM**
When the Search function is on, **SEARCH** or **SEARCH ALBUM** is lit according to the selected mode.
- ② **SHUFFLE**
SHUFFLE is lit when this function is on.
- ③ **REPEAT display**
When the Repeat function is on, the display shows the repeat playback mode currently selected.
- ④ **INTRO**
INTRO is lit when this function is on.
- ⑤ **MEMORY**
MEMORY is lit when Program playback is on.
- ⑥ **ESP display**
(ESP) is lit when ESP (Electric Shock Protection) is on.
- ⑦ **DISC / FOLDER display**
CD icon lights when a CD is loaded. When a MP3 disc containing folders is loaded, the display shows the total number of the folders.
- ⑧ **Track number display**
When a CD is loaded, the display shows the total number of tracks. When a MP3 disc containing folders is loaded, the display shows the total number of the folders.

NOTE

When in search mode (MP3 only), the initial letter of a track name appears on the display (see "Search for a name of track" on page 20).

- ⑨ **Counter display**
This shows the time information of the disc.

NOTE

When in search mode (MP3 only), the display shows a track name (see "Search for a name of track" on page 20).

3 – Disc operations

MP3 files and directories

CDs containing MP3 files can be played by the CD-160MKII with the following limitations on the number of files and directories.

Maximum number of directories: 200

Maximum number of MP3 files: 500

File format: MPEG 1/2/2.5 Layer2/3(ISO/IEC 11172-3, ISO/IEC 13818-3.2)

Bit rate: 32kbps to 320kbps (over 128kbps is recommended)

Sampling frequency: 32 kHz/44.1 kHz/48 kHz, Mono or Stereo

File extension: mp3, Mp3, mP3, MP3

NOTE

The CD-160MKII can only read the files in the first session of a multi-session disc.

ID3 tag display for MP3 playback is not supported.

If audio data is converted with Variable Bit Rate, it may not be played back properly.

MP3 files are played as the order in the following diagram.

In this manner, playback is performed from the top level directories.

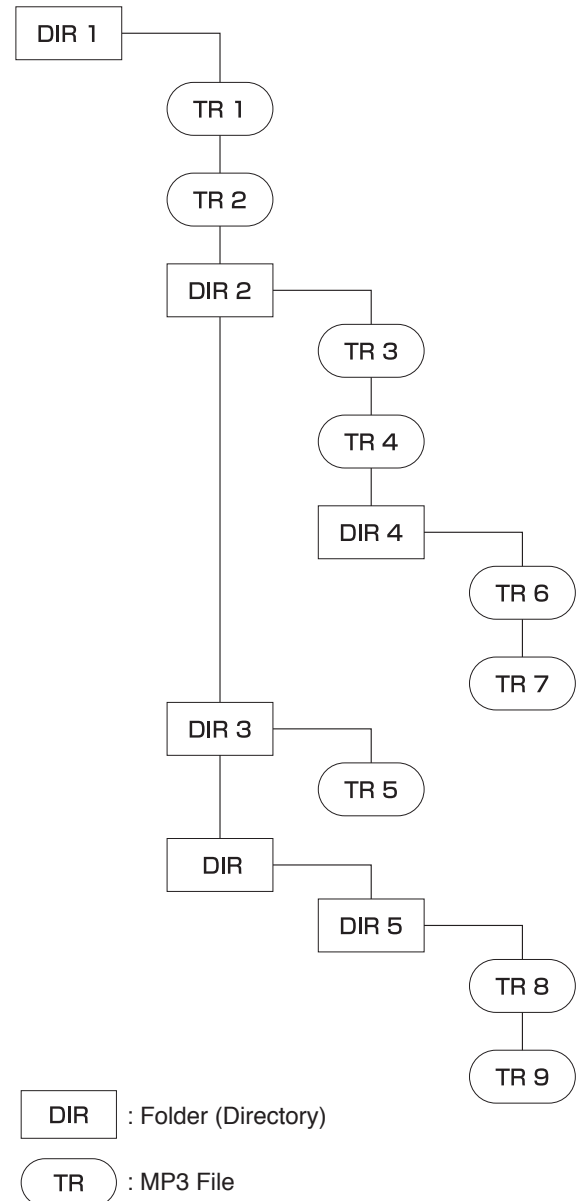

3 – Disc operations

Listening to CD/MP3 (1)

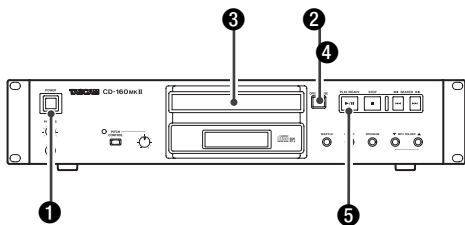

1. Press the POWER switch to turn the unit on.

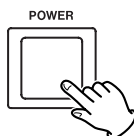

2. Press the OPEN/CLOSE key.

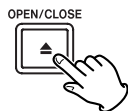

3. Place a disc on the tray with the printed label face up.

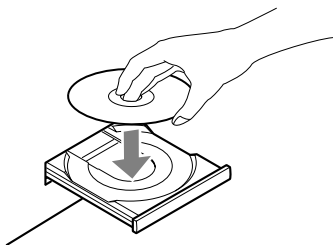

CAUTION

Never place more than one disc on the tray.

The disc must be loaded centrally into the disc tray. If the disc is not correctly loaded, it may not be possible to open the tray again once it has closed, so you should ensure the disc is always centrally loaded in the tray.

Do not force the tray by hand during opening and closing operations.

4. Press the OPEN/CLOSE key to close the CD door.

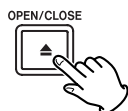

It takes a few seconds for the unit to load the disc. No keys will work during loading. Wait until the total number of the tracks and the total play time of the disc are displayed.

When no disc is loaded in the CD player, NO DISC is displayed.

When a CD is loaded:



When a MP3 disc is loaded:

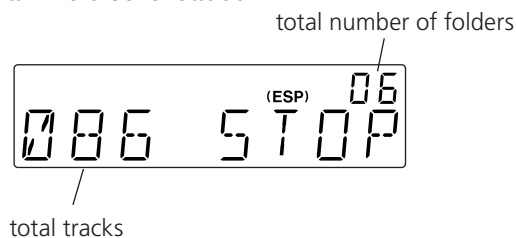

5. Press the PLAY/READY key (▶/||) to start playback.



Playback starts from the first track of the disc.

When the playback of all the tracks has finished, the unit stops automatically.

NOTE

MP3 tracks recorded out of folders are automatically put in the "ROOT" folder, and playback starts from the first track of the ROOT folder.

3 – Disc operations

Listening to CD/MP3 (2)

■ To suspend playback temporarily (pause mode)

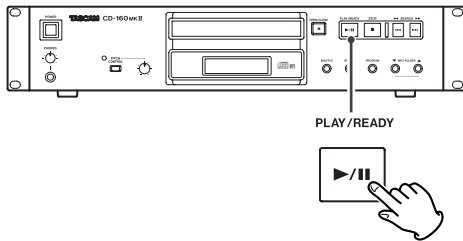

Press the **PLAY/READY** key (▶/||) during playback. Playback stops at the current position. To resume playback, press the **PLAY/READY** key (▶/||) again.

■ To stop playbacks

Press the **STOP** key (■) to stop playback.

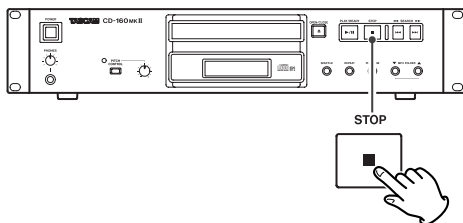

■ Search for a part of a track

During playback, hold down the skip key (◀◀ or ▶▶) and release it when the part you want to listen to is found.

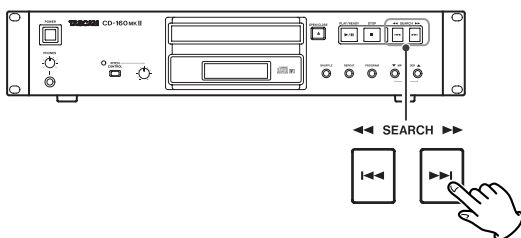

■ To skip to the next or a previous track

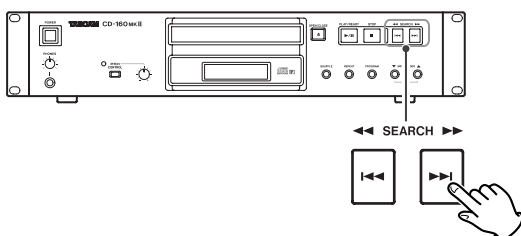

During playback, press the skip key (◀◀ or ▶▶) repeatedly until the desired track is found. The selected track will be played from the beginning.

In the stop mode, press the skip key (◀◀ or ▶▶) repeatedly until the track you want to listen to is found. Press the **PLAY/PAUSE** key (▶/||) to start playback from the selected track.

During playback, when the ◀◀ key is pressed, the track being played will be played from the beginning. To return to the beginning of the previous track, press the ◀◀ key twice.

During programmed playback, the next or previous track in the program is played.

■ Direct Playback

While in stop or playback mode, you can use the numeric keys of the remote control unit to select a track.

Select a track using the numeric keys, and within 10 seconds press the **PLAY/READY** key.

Playback starts from the selected track.

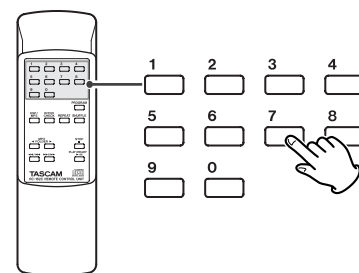

For instance, to select track number 35, press 3 and 5.

To play tracks 1 to 9, simply press the corresponding keys (1 to 9).

NOTE

Direct playback isn't possible during shuffle playback and programmed playback.

■ Pitch control

NOTE

Changing pitch rapidly during playback may cause noise problems.

When you use the Pitch Control function, no signal is output from the DIGITAL OUT.

1. Press the **PITCH CONTROL** key in the stop mode. The **LED** will light.

This key can be pressed during playback.

2. Turn the **PITCH CONTROL** knob right or left to change pitch.
3. Turning right makes playback speed faster within the range 0 to +12%.
4. Turning left makes playback speed slower within the range 0 to -12%.

3 – Disc operations

■ Listening through headphones

WARNING

Always lower the volume level prior to plugging in your headphones. TO AVOID DAMAGING YOUR HEARING. Do not place your headphones on your head until after you have plugged them in.

For private listening, insert the plug from your headphones into the **PHONES** jack, and adjust the volume by turning the **LEVEL** knob.

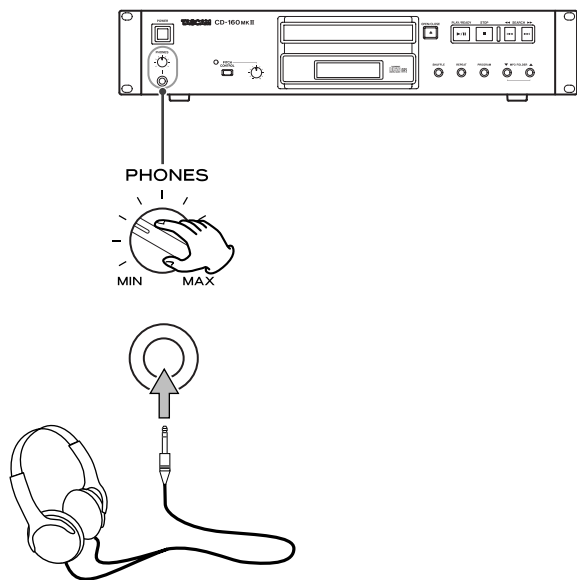

The **ESP (Electronic Shock Protection)** stores the music in the buffer to prevent sound from skipping.

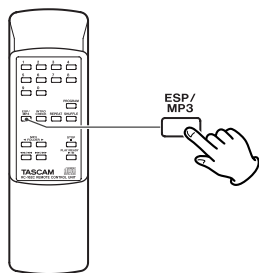

During playback of a CD, press the **ESP** key to turn the ESP on or off. When you turn the ESP on, 40 SEC (40 seconds) briefly appears, and the **ESP** indicator lights on the display.

The **ESP** indicator blinks while the unit is filling the buffer.

NOTE

When the unit is on the stable place and free from mechanical shocks, you can turn this function off.

During playback of MP3, this function is always ON, and this unit can output the digital audio data from its digital output jacks. However, during playback of a CD, when ESP is ON, the unit cannot output digital audio data.

To display the MP3 information

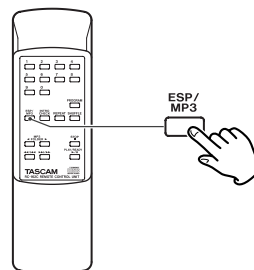

During playback of MP3 disc, press the **MP3** key for more than 1 second. The information about the current track is displayed as follows:

Filename → Title → Artist → Album

NONE appears when there is no information.

UNKNOWN appears when the unit cannot read the information.

Press the **MP3** key for more than 1 second again to cancel the MP3 information mode.

■ Skip to the next folder (MP3)

Press the **MP3 FOLDER** keys to skip folders.

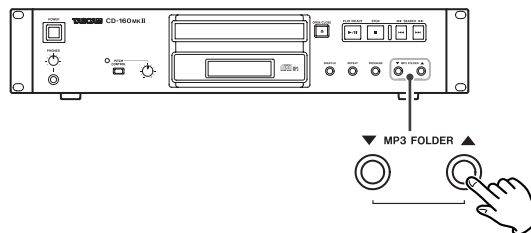

3 – Disc operations

Programmed Playback

Up to 64 tracks can be programmed in the desired order. Shuffle function doesn't work during programmed playback.

1. Press the PROGRAM key in the stop mode.

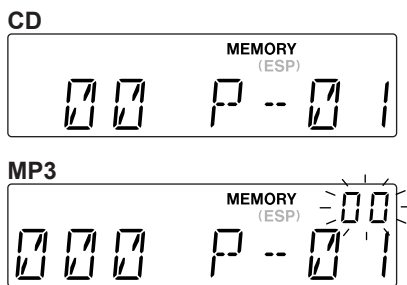
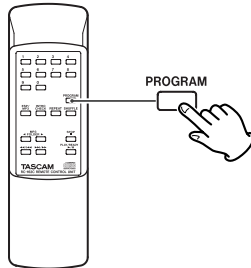

The MEMORY indicator appears on the display.

- To cancel the program mode, press the STOP key (■).

2. Press the numeric keys (or press the skip key (I◀◀ or ▶▶I) repeatedly) to select a folder on a MP3 disc, then press the PROGRAM key.

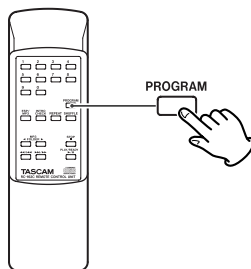
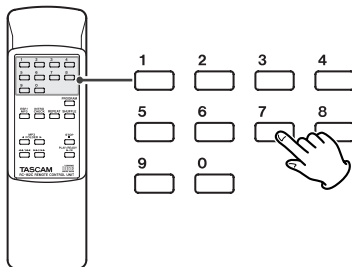

- MP3 tracks recorded out of folders are in the "01" (ROOT) folder.
- Skip this step when playing a CD.

3. Press the numeric keys (or press the skip key (I◀◀ or ▶▶I) repeatedly) to select a track, then press the PROGRAM key.

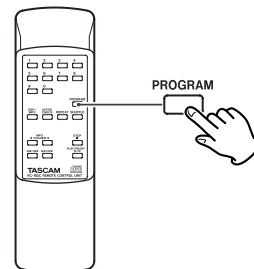
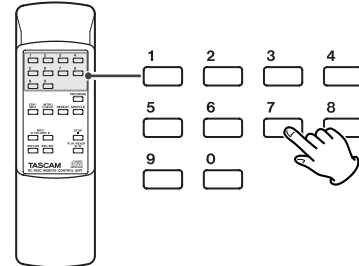

The track is programmed, and P-02 is displayed.

- Repeat steps 2 and 3 to program more tracks.
- You can program up to 64 tracks.

4. When the selection of track numbers is completed, press the PLAY/READY key (▶/II) to start programmed playback.

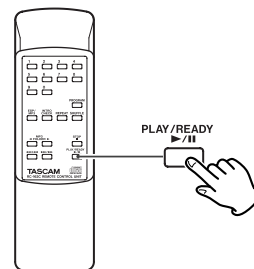

- When the playback of all the programmed tracks has finished, or if the STOP key is pressed, the MEMORY indicator will go off and the program mode will be cancelled.

The program is retained in memory until the OPEN/CLOSE key or the POWER switch is pressed. You can return to the programmed playback by pressing the PROGRAM key and the PLAY/READY key (▶/II).

3 – Disc operations

■ To check the programmed order

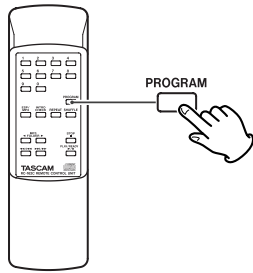

In the stop mode, press the **PROGRAM** key repeatedly. The track number and program number will be shown on the display.

■ To add a track to the end of the program

In the stop mode, press the **PROGRAM** key repeatedly until appears on the display. Select a track number using the numeric keys or the skip key (◀◀ or ▶▶) and then press the **PROGRAM** key. The track is added to the end of the program.

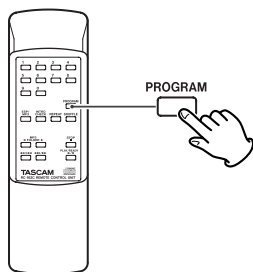
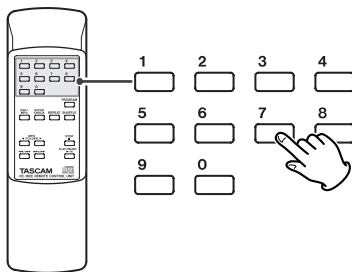
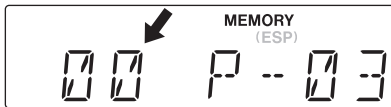
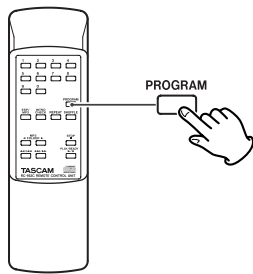

■ To overwrite the program

In the stop mode, press the **PROGRAM** key repeatedly until the program number to be changed appears on the display.

Select a new track number using the numeric keys or the skip key (◀◀ or ▶▶) and then press the **PROGRAM** key.

■ To clear program

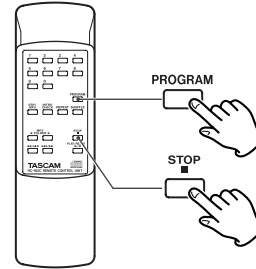

To clear the programmed contents, press the **PROGRAM** and the **STOP** key (■) in the stop mode.

- If the **OPEN/CLOSE** key or the **POWER** switch is pressed, the programmed contents will also be cleared.

3 – Disc operations

Repeat Playback

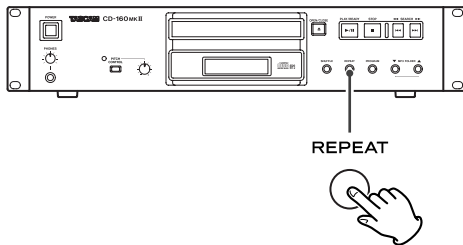

Every time the **REPEAT** key is pressed, the mode is changed as follows:

When a CD is loaded:

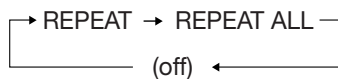

When a MP3 disc is loaded:

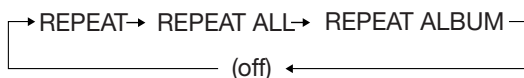

NOTE

The Repeat mode will be canceled if one of the following keys is pressed: STOP, INTRO CHECK, POWER, OPEN/CLOSE.

■ Repeat one track (REPEAT)

Press the **REPEAT** key once during playback. **REPEAT** lights.

The track being played will be played repeatedly. If you press the skip key (◀◀ or ▶▶) and select another track, the track you selected will be played repeatedly.

It is also possible to select a track to be repeated in the stop mode. Press the **REPEAT** key, select a track using the skip key (◀◀ or ▶▶), and then press the **PLAY/READY** key (▶/||) to start playback.

■ Repeat all the tracks (REPEAT ALL)

All the tracks will be played repeatedly.

Press the **REPEAT** key twice. **REPEAT ALL** lights.

During programmed playback, programmed tracks will be played repeatedly.

■ Repeat all the tracks in the folder (REPEAT ALBUM) (MP3 only)

All the tracks in the folder will be played repeatedly.

Press the **REPEAT** key three times. **REPEAT ALBUM** lights.

Shuffle Playback

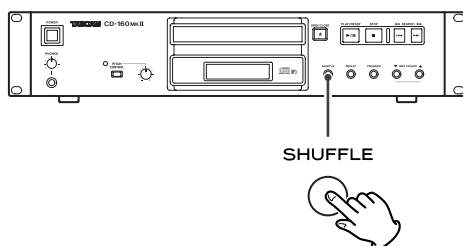

The tracks can be played randomly. Press the **SHUFFLE** key during playback or when in the stop mode. **SHUFFLE** will then light up in the display.

- If you press the ▶▶ key during shuffle playback, next track will be randomly selected and played. If you press the ◀◀ key, the currently played track will be played from the beginning. A track cannot be replayed during shuffle playback.
- Shuffle playback doesn't work during programmed playback.
- If one of the following keys is pressed, shuffle mode will be cancelled: **SHUFFLE**, **STOP**, **INTRO CHECK**, **POWER**, **OPEN/CLOSE**.

Intro Check

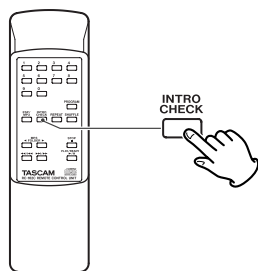

Press the **INTRO CHECK** key in the stop or play mode.

The **INTRO** indicator lights on the display, and the beginning of all the tracks is played for 10 seconds each. When

a track you want to listen to is found, press the **INTRO CHECK** key to resume normal playback.

- To skip to the next or a previous track, press the skip key.
- To stop Intro Check function, press the **STOP** key.
- Repeat and shuffle playback don't work during the intro check.
- If one of the following keys is pressed, the intro check mode will be cancelled: **INTRO CHECK**, **SHUFFLE**, **STOP**, **POWER**, **OPEN/CLOSE**.

3 – Disc operations

Search Mode (MP3 only)

Search for a name of track

You can select the track by searching for its name.

1. Press the MP3 key once.

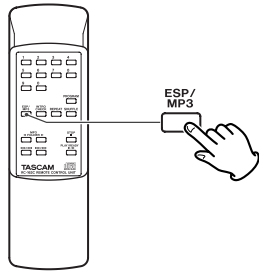

An alphabet (initial letter of a track name) and a track number are displayed.

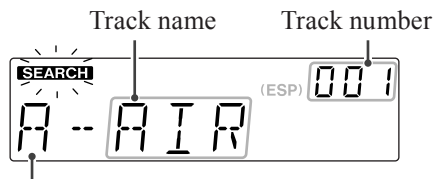

- To cancel the search mode, press the **STOP** key (■).

2. Select the initial letter of the track you want to listen to by pressing the skip key (I◀◀ or ▶▶I).

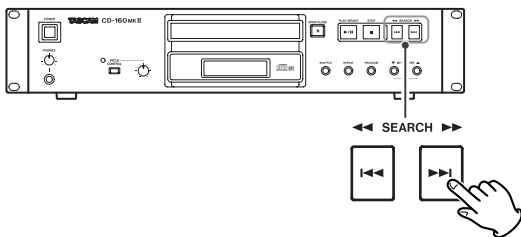

3. Press and hold the skip key (I◀◀ or ▶▶I).

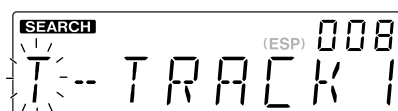
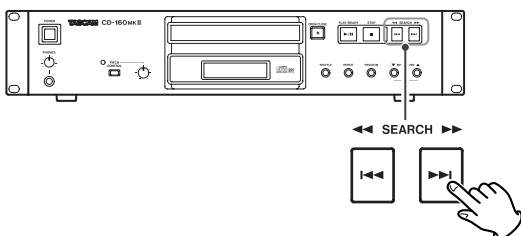

4. Select the track that has same initial letter by pressing the skip key (I◀◀ or ▶▶I).

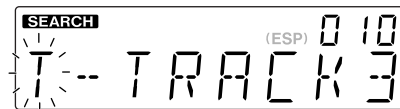
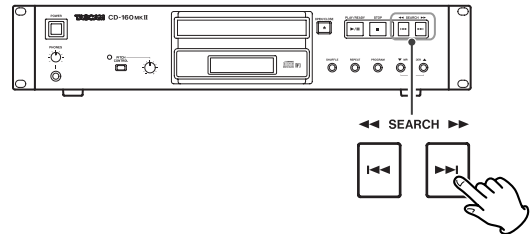

5. Press the PLAY/READY key (▶/||).

Playback starts from the selected track.

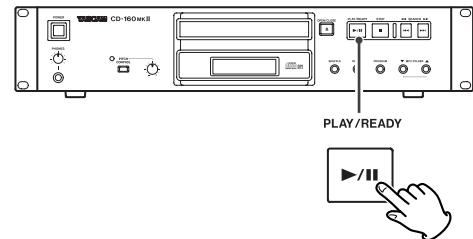

3 – Disc operations

Search for a track in a folder

1. Press the MP3 key twice.

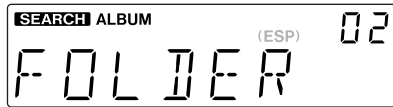
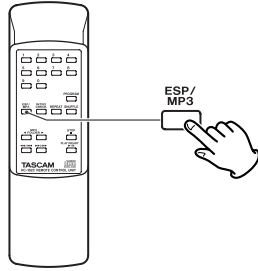

The name of folder is displayed.

2. Press the skip key (◀◀ or ▶▶) to find the folder that the track you want to listen to is included.

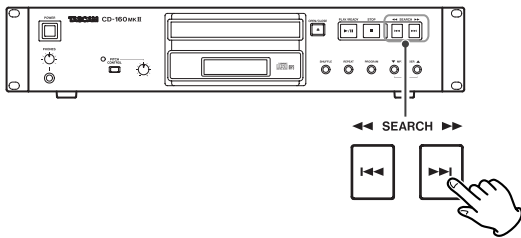

- MP3 tracks recorded out of folders are in the “ROOT” folder.

3. Press and hold the skip key (◀◀ or ▶▶).

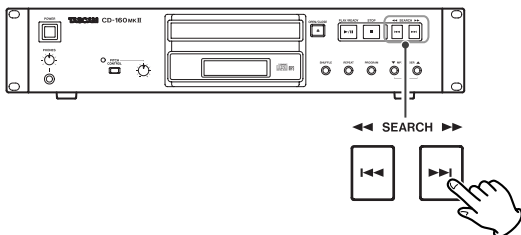

4. Select the track in the folder by pressing the skip key (◀◀ or ▶▶).

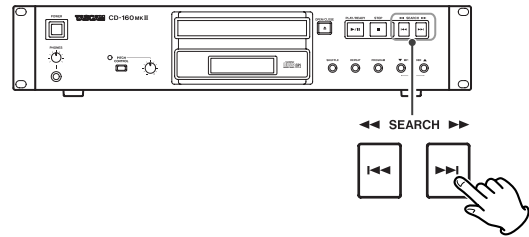

5. Press the PLAY/READY key (▶/||) to start playback.

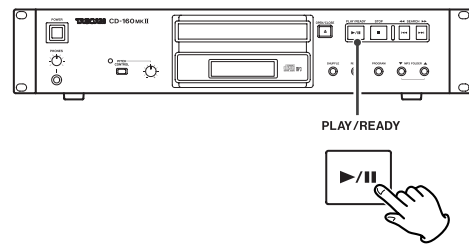

Playback starts from the selected track.

- If you skip steps 3 and 4, playback will start from the first track in the selected folder.

4 – Reference and specifications

Troubleshooting

If you have problems with your system, look through this chart and see if you can solve the problem yourself before calling your dealer or TEAC service center.

■ No power

→ Check the connection to the AC power supply. Check and make sure the AC source is not a switched outlet and that, if it is, the switch is turned on. Make sure there is power to the AC outlet by plugging another item such as a lamp or fan into the outlet.

■ Remote control doesn't work.

- Press the POWER switch of the main unit to turn it on.
- If the batteries are dead, change the batteries.
- Use remote control unit within the range (5 m) and point at the front panel.
- Clear obstacles between the remote control unit and the main unit.
- If a strong light is near the unit, turn it off.

■ No sound

- Check the connection to the amplifier.
- Check the operation of the amplifier.

■ Will not play.

- Load a disc with the playback side facing down.
- If the disc is dirty, clean the surface of the disc.
- A blank disc has been loaded. Load a prerecorded disc.
- Depending on the disc, etc. it may not be possible to play back CD-R/RW discs. Try again with another disc.
- You cannot play back unfinalized CD-R/RW discs. Finalize such a disc in a CD recorder and try again.

■ Sound skips.

- Place the unit on a stable place to avoid vibration and shock.
- If the disc is dirty, clean the surface of the disc.
- Don't use scratched, damaged or warped discs.

If normal operation cannot be recovered, unplug the power cord from the outlet and plug it again.

Maintenance

If the surface of the unit gets dirty, wipe with a soft cloth or use diluted mild liquid soap. Never spray liquid directly on this unit. Apply your cleaner to your cleaning cloth and wipe gently. Be sure to remove any excess completely. Do not use thinner, benzene or alcohol as they may damage the surface of the unit. Allow the surface of the unit to dry completely before using.

4 – Reference and specifications

Specifications

CD Player

Pickup	3-beam, semiconductor laser
Digital filter	8-times oversampling
Frequency Response	20 Hz - 20 kHz \pm 2dB
Total Harmonic Distortion	Less than 0.03 % (1 kHz, ESP off)
Signal-to-Noise Ratio (S/N)	More than 83 dB (IHF-A, ESP off)
Output	Analog: Nominal output level -10 dBV Maximum output level +6 dBV \pm 2dB Digital: Coaxial / IEC-60958-3 (S/PDIF) Optical / IEC-60958-3 (S/PDIF)

General

Power Requirement	AC 120 V, 60 Hz (U.S.A./Canada) AC 230 V, 50 Hz (U.K./Europe) AC 240 V, 50-60Hz (Australia)
Power Consumption	10 W (U.S.A./Canada) 10 W (U.K./Europe) 10 W (Australia)
Dimensions (W x H x D)	481 x 94.5 x 298 (mm) / 18.94 x 3.72 x 11.73 (in)
Weight	4.1 kg (9.0 lb)

Dimensions

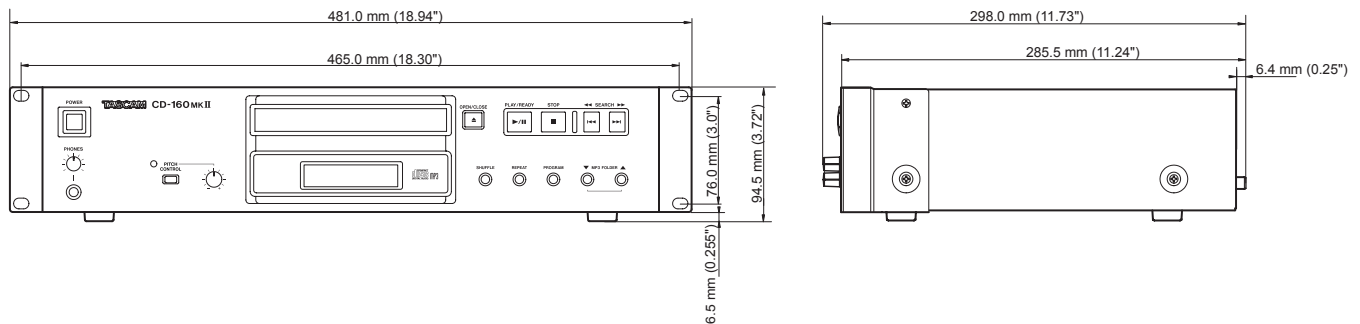

TASCAM

TEAC Professional Division

CD-160MKII

TEAC CORPORATION

Phone: +81-422-52-5082

3-7-3, Nakacho, Musashino-shi, Tokyo 180-8550, Japan

www.tascam.com

TEAC AMERICA, INC.

Phone: +1-323-726-0303

7733 Telegraph Road, Montebello, California 90640

www.tascam.com

TEAC CANADA LTD.

Phone: +1905-890-8008 Facsimile: +1905-890-9888

5939 Wallace Street, Mississauga, Ontario L4Z 1Z8, Canada

www.tascam.com

TEAC MEXICO, S.A. De C.V

Phone: +52-555-581-5500

Campesinos No. 184, Colonia Granjes Esmeralda, Delegacion Iztapalapa CP 09810, Mexico DF

www.tascam.com

TEAC UK LIMITED

Phone: +44-8451-302511

Unit 19 & 20, The Courtyards Hatters Lane, Watford, Hertfordshire. WD18 8TE, U.K.

www.tascam.co.uk

TEAC EUROPE GmbH

Phone: +49-611-71580

Bahnstrasse 12, 65205 Wiesbaden-Erbenheim, Germany

www.tascam.de
