

TASCAM

TEAC Professional Division

34B

4-Track Recorder/Reproducer





OPERATION/MAINTENANCE

5700050901

The guarantee of performance that we provide for the 34B must have several restrictions. We say that the recorder will perform properly only if it is adjusted properly and the guarantee is that such adjustment is possible. However, we cannot guarantee your skill in adjustment or your technical comprehension of this manual. Therefore, Basic Daily Setup is not covered by the Warranty. If your attempts at internal adjustments such as rebias and record EQ trim are unsuccessful, we must make a service charge to correct your mistakes.

Recording is an art as well as a science. A successful recording is often judged primarily on the quality of sound as art, and we obviously cannot guarantee that. A company that makes paint and brushes for artists cannot say that the paintings made with their products will be well received critically. The art is the province of the artist. TASCAM can make no guarantee that the 34B *by itself* will assure the quality of the recordings you make.

Your skill as a technician and your abilities as an artist will be significant factors in the results you achieve.

<p>CAUTION RISK OF ELECTRIC SHOCK DO NOT OPEN</p>	<p>CAUTION: TO REDUCE THE RISK OF ELECTRIC SHOCK, DO NOT REMOVE COVER (OR BACK). NO USER-SERVICEABLE PARTS INSIDE. REFER SERVICING TO QUALIFIED SERVICE PERSONNEL.</p>
	<p>The lightning flash with arrowhead symbol within an equilateral triangle, is intended to alert the user to the presence of uninsulated "dangerous voltage" within the product's enclosure, that may be of sufficient magnitude to constitute a risk of electric shock to persons.</p>
	<p>The exclamation point within an equilateral triangle is intended to alert the user of the presence of important operating and maintenance (servicing) instructions in the literature accompanying the appliance.</p>

WARNING: TO PREVENT FIRE OR SHOCK HAZARD, DO NOT EXPOSE THIS APPLIANCE TO RAIN OR MOISTURE.

This recorder/reproducer has a serial number located on the rear panel. Please record the model number and serial number and retain them for your records.
 Model Number _____
 Serial Number _____

TABLE OF CONTENTS

Introduction to the 34B and Its Design		
Philosophy	4	
Features and Controls	5	
Basic Information	10	
Entering "Record"	12	
Basic Connection and Hook-up	15	
What is Simul-Sync?	18	
Monitor Methods	19	
Connection and Operation of the DX-4D	20	
Accessory Information	21	
Voltage Conversion	25	
Note for U.K. Customers	25	
Specifications of the 34B	26	
Theory of Operation – Maintenance	28	
Daily Setup	35	
General Advice on Maintenance	35	
MAINTENANCE		
1. Circuit Description		
1-1. Logic Used in the Tape Deck	38	
1-2. System Control IC		
1-2-1. Pin Assignments and Their Functions	38	
1-2-2. Block Diagram	39	
1-2-3. Input Signals and Resulting Modes	39	
1-2-4. Mode Transition	40	
1-2-5. Operation with more than One Input Signal	40	
1-2-6. Input/Output Levels	40	
1-2-7. Initial Reset Circuit	41	
1-3. Power Shut-Off Circuit	41	
1-4. Capstan and Brake Solenoid Drive Circuit	42	
1-5. Reel Motor Drive Circuit	44	
1-6. Tape Direction Sensing and Counter Clock Generation Circuit	46	
1-7. Counter Clock Pulse	47	
1-8. Motion Sensing Circuit	47	
1-9. F.F. and REW Operation	48	
1-10. Electrical Brake System	48	
1-11. Counter Zero Return	50	
1-12. Punch In/Out Control Circuit	52	
1-13. Edit Control Circuit	54	
1-14. Rec and Play Mute Signals	54	
1-15. Display Circuit	55	
1-16. Amplifier Circuit Description		
1-16-1. Power Muting Circuit	56	
1-16-2. Relay Circuit	56	
1-16-3. Bias and Record Control Circuit	58	
1-16-4. Monitor Circuit	60	
2. Checks and Adjustments		
2-1. Essential Test Equipment Required	62	
2-2. Removing the Panels of the Deck	63	
2-3. Capstan Thrust Clearance	64	
2-4. Brake Mechanism	64	
2-5. Brake Torque	64	
2-6. Reel Motor Torque		
2-6-1. Take-Up Torque	65	
2-6-2. Back Tension	66	
2-7. Pinch Roller Pressure	66	
2-8. Reel Table Height Adjustment	67	
2-9. Tape Speed	67	
2-10. Wow and Flutter Check	67	
2-11. Record/Reproduce Amplifier Checks and Adjustments		
Preliminary Adjustments	68	
2-11-1. Input Level Calibration	71	
2-11-2. Meter Calibration (Input)	71	
2-11-3. MIC IN Level Check	71	
2-11-4. PHONES Level Check	71	
2-11-5. Reproduce Level Calibration	71	
2-11-6. Meter Calibration (Tape)	71	
2-11-7. Reproduce Frequency Response	72	
2-11-8. Bias Tuning and Bias Trap Adjustments	72	
2-11-9. Recording Bias Adjustment	73	
2-11-10. Recording Level Adjustment	73	
2-11-11. Frequency Response (Overall)	73	
2-11-12. Signal-to-Noise Ratio (Overall)	74	
2-11-13. Erase Ratio	75	
2-11-14. Adjacent Channel Crosstalk	75	
2-11-15. Distortion	75	
Service Chart	76	
3. Exploded Views and Parts Lists	78	
4. PC Boards and Parts Lists	91	
Schematic Diagrams	Insert	

Bescheinigung des Herstellers/Importeurs

Hiermit wird bescheinigt, daß der/die/das

MAGNETTONBANDGERÄT TASCAM 34B

(Gerät, Typ. Bezeichnung)

in Übereinstimmung mit den Bestimmungen der

AMTSBLATT 163/1984, VFG 1045/1984

(Amtsblattverfügung)

funk-entstört ist.

Der Deutschen Bundespost wurde das Inverkehrbringen dieses Gerätes angezeigt und die Berechtigung zur Überprüfung der Serie auf Einhaltung der Bestimmungen eingeräumt.

TEAC CORPORATION

Name des Herstellers/Importeurs

Note:

If you notice any differences, either on the outside or the inside of the unit from the illustrations and descriptions in this manual, talk to your dealer. He may have revision sheets that will show manufacturing changes, or notifications of how to deal with any changes in set-up or maintenance procedures.

Save this manual, refer to it when necessary, and good luck with your 34B.

Introduction to the 34B and Its Design Philosophy

No matter how elaborate a multichannel tape recorder is, it doesn't do the job without help. A lot of equipment is involved, and a lot of talent as well. The recorder becomes the keystone in a system that involves microphones, mixers, loudspeakers, amplifiers and many sophisticated electronic devices. Everything contributes a part to the system of multichannel recording.

Because of what we have learned about multichannel recording systems in the past 15 years, TASCAM decided to concentrate on improving functions in the 34B that are strictly the province of the tape recorder. The result, a better and more flexible recorder/reproducer for the system of multitrack recording. This logical growth now reflects the needs of the studio style or, if you will, the professional recordist.

It has long been our contention that professionalism is defined by people and what results they achieve. It's not something that automatically happens when you buy a tape machine with a lot of tracks, or a very high price. It's what you do with the equipment and how well you do it that makes the point.

In designing the 34B, we believe we have been guided by the multichannel system as it truly is. We are sure our recorder/reproducer can deliver the performance necessary to achieve solid results.

If you would like to comment on our design philosophy, please feel free to contact us. Criticism and comment from our owners has helped us improve our products and our business. We welcome all feedback.

Please send in the warranty card. Although it is not absolutely necessary to insure warranty protection, it will allow us to learn some things about who you are and what you do with tape. From time to time we mail out literature and information of interest to the multichannel recordist. Let us know where you are and we'll keep in touch.

*dbx is a trademark of dbx Incorporated. dbx noise reduction system manufactured under license from dbx Incorporated.

FEATURES AND CONTROLS

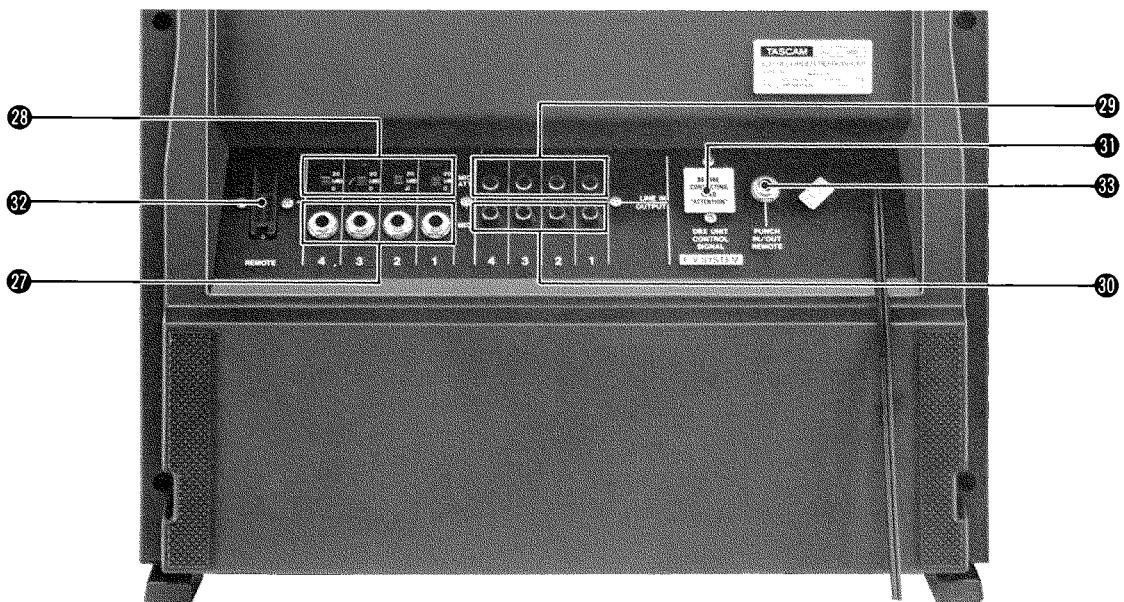
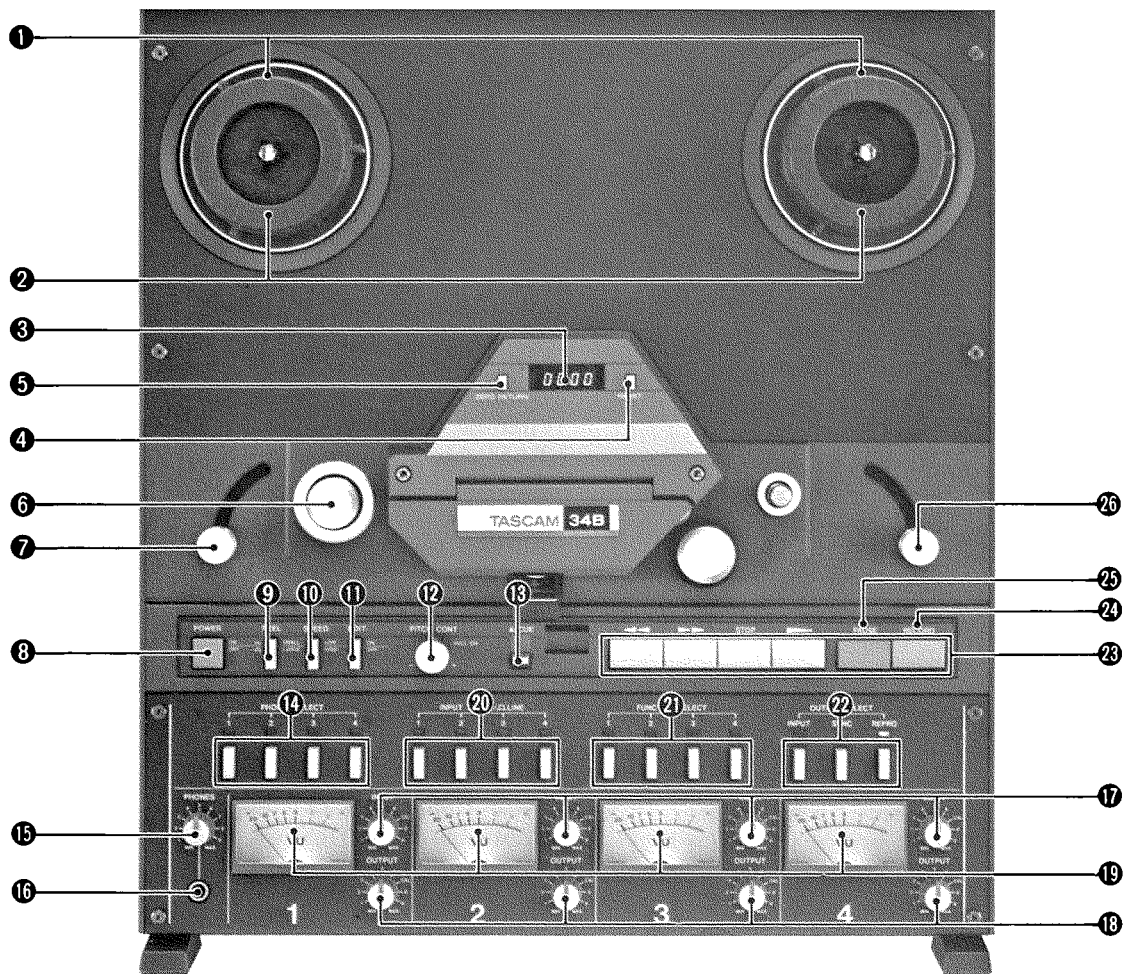

① Reel Tables

Support either 7" reels or hub adaptors when 10-1/2" reels are used. Use the same size and kind of reels. See page 10 for details.

② NAB Hub Adaptors

These can be installed to allow use of 10-1/2" reels. Rotate adaptor ring CW to fully tighten.

③ Digital Counter

A four digit green fluorescent counter which provides a numerical index relative to tape position.

④ RESET Button

Press this button to obtain "0000" when determining the record start position (ZERO RETURN position).

⑤ ZERO RETURN Button

When depressed, counter 0000 may be considered a one position "autolocator" allowing rewind (◀) to find one spot (0000) on the tape without the use of the cue lever. You won't need an audible cue to find this location, and accidents to the tape or damage to the monitor system tweeters will be avoided. This auto stop function is only possible in rewind (◀), and the transport will not stop at 0000, if you are using (▶) fast forward.

1. If the rewind time is short, the transport will stop at 999, not precisely on the "mark".
2. If the rewind time is long (half a reel of tape) the transport will cycle between (▶) and (◀) several times and finally come to rest at counter 999.

Tape slippage will lower the accuracy of the "stop" point. So, always check by listening before re-recording. You may not be exactly "on-cue". Take care.

CAUTION:

Once the ZERO RETURN operations are completed, make sure to reset this button to (□ OFF).

⑥ Impedance Roller

Sometimes referred to as a "flutter filter", which insures even tape travel across the heads and low wow and flutter performance.

⑦ Tension Arm

Maintains even tape tension and compensates for slight irregularities in the supply reel.

⑧ POWER Switch

When depressed (≡ ON), the digital counter and VU meters light. Press again (□ OFF) to turn off.

⑨ REEL Switch

When large diameter 10-1/2" reels are used greater back tension is required for correct operation. 7" reels require less back tension. This switch sets the correct amount of back tension; set it to suit the size of reel you are using on the supply side.

⑩ SPEED Switch

LOW (≡) selects a tape speed of 7-1/2 ips and HIGH (□) selects a tape speed of 15 ips.

⑪ EDIT Switch

Depress to activate, depress again to release.

CAUTION:

Edit mode may only be activated safely from STOP. When this button is depressed, the takeup reel motor is released from transport logic control. If the recorder is in either fast forward or rewind, and the EDIT button is depressed, only the STOP and PLAY buttons will function. Fast motion in either direction will not be accepted as a command after STOP until the EDIT button is released. This protective restriction must be included in the logic or the transport may spill tape uncontrollably.

When EDIT is depressed, pressing PLAY (▶) activates the capstan motor and the pinch roller solenoid regardless of the position of the takeup tension shutoff arm. The takeup reel will not move, and the tape will "spill". This will allow you to listen to the playback of an unwanted section without winding that part of the tape on to the takeup reel. When you hear that the section that you wish to remove (edit out) has completely "spilled", or "dumped", a splice can be made, the desired parts can be joined together, and the unwanted length of tape discarded. As you can see, the "safety features" such as brakes and tape tension detection must be bypassed in order to provide these edit capabilities, so take care.

12 PITCH CONTROL

PULL ON to engage a $\pm 12\%$ variation of the tape speed in the recording or reproducing modes.

Pull out and turn to the left (-) to decrease the speed of the tape transport; turn to the right (+) to increase the transport speed.

Push in to disengage.

NOTE:

Since this pitch control is active in record as well as reproduce, it is wise to check and make sure that it is disengaged (pushed in) when not wanted.

13 CUE Lever

This control will defeat the fast motion tape lifters. The more pressure you apply, the closer the tape will come to the heads. This will allow the reproduce signal to be heard in fast motion for cueing. Use only enough pressure to hear the signal. Too much signal will damage the electronics, and if your monitor system is turned up, high frequency playback signal will damage your loudspeakers so be sure the cue lever is not engaged (locked) when in fast motion. The latch position is provided only for hand winding the tape to find an edit point. Push down on the lever to release.

CAUTION:

Use of the cue lever in fast forward or rewind will greatly accelerate head wear.

14 PHONES SELECT Switches

Select which of track(s) will feed the headphone amplifier. The source, Input or Tape, is determined by the position of the FUNCTION SELECT and OUTPUT SELECT Switches.

15 PHONES Level Control

Controls the level of the mix selected by the PHONES SELECT Switches.

16 PHONES Jack

This 1/4" phone jack is where you connect your stereo headphones. The signal at this point is the same as the signal at the OUTPUT (Line Out) jacks. This output is designed for 8 ohm stereo headphones.

CAUTION:

MONO (2 WIRE) HEADPHONES WILL CAUSE CIRCUIT FAILURE. If your headphones have this connector, don't use them

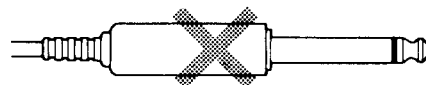

(1/4" phone 2-connector)

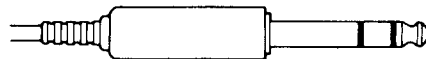

(1/4" phone 3-connector)

Your headphone connector must 3 sections to be safe. While accidents do happen, and protection circuit have been built in, use of mono/2 wire headphones will eventually cause circuit failure (2 to 3 minutes).

Using the 2 wire connector shorts out the amplifier driving the headphones, which will cause it to burn out.

17 INPUT Level Control

Adjusts the record level of the track. The "CAL" position provides a nominal setting to be used for set-up, calibration and with a mixer when levels must be consistent and repeatable. For more information on calibrating the Recording System see page 16.

18 OUTPUT Level Control

Adjust the playback level of the track. In the SYNC and REPRODUCE modes the playback signal is available at the rear panel OUTPUT jacks, the VU meters and the PHONES SELECT Switches. The "CAL" position function is the same as the INPUT Level CAL.

19 VU Meters

The INPUT and OUTPUT Volume level controls will affect the meter level.

20 INPUT SELECT MIC/LINE Switches

In the out position (LED off) the line input is selected. Depressing this switch (in) selects Mic input and lights the corresponding LED.

21 FUNCTION SELECT Switches and LEDs

These four switches determine whether a track will enter record mode when RECORD and PLAY are pressed. An LED indicates each track's record status ("Record Safe", "Record Ready", or "Record" mode):

LED off: Record Safe Mode, no recording can take place.

LED blinks: Record Ready Mode, recording will occur when "Record" is engaged and the tape is moving.

LED on: Record or Record/Pause.
 Record, the tape is moving and recording is taking place.
 Record/Pause, recording will begin when play is selected.

22 OUTPUT SELECT Buttons

Select which of three possible sources to feed the OUTPUT jacks (rear panel), VU meter circuits and PHONES SELECT Switches. The LED's above the buttons show selection.

- INPUT – Meter reads line input to recorder, input signal appears at OUTPUT jacks, and PHONES SELECT Switches. Tape signal will not be heard.
- SYNC – Used for all normal operations, recording, sync/reproduce and reproduce. Meter reads input or sync/reproduce head (#2) play output depending on setting of FUNCTION SELECT Switches.
- REPRODUce – Selects the reproduce head (#3). Meter now reads tape playback. Does not prevent recording on head #2. Used in set-up to check performance and record/play monitoring of tape.

OUTPUT SELECT		FUNCTION SELECT		OUTPUT and VU METERS
Switch	LED	Switch	LED	
Input	on	out	off	Input/Source
		in	blinks	
Sync	on	out	off	Tape
		in	blinks	Input/Source
Repro	on	out	off	Tape
		in	blinks	

23 Transport Controls

This group of buttons control the mechanical action of the transport, and the in/out switching of the record circuit. The RC-71 remote control unit (see rear panel for the connection point) will duplicate this control group. When the remote is connected, both sets of controls will be active at the same time.

(▶) Play Button

1. When depressed alone, the tape will advance at the speed selected by the SPEED switch and the PITCH CONTROL.
2. When depressed along with the RECORD button, any or all tracks that have their FUNCTION SELECT buttons IN (record ready) will begin recording immediately.
3. This transport has a motion sensing circuit that allows the selection of PLAY directly from either fast forward or rewind. Press PLAY when fast winding and the transport will slow, come briefly to STOP and then enter PLAY by itself.

(►►) Fast Forward Button

(◀◀) Rewind Button

Rewind time is 90 seconds for a 10-1/2" reel, 1-1/2 mil tape.

STOP Button

RECORD Button

Depressing this button by itself will have no effect. To begin recording, several conditions must first be met.

1. One or more FUNCTION SELECT buttons must be IN (record ready).
2. To enable the record logic, the PLAY button must be depressed simultaneously with the RECORD button. If the transport is in PLAY, press BOTH buttons together and the unit will go into record mode.
3. The PAUSE button can hold the record logic in an active condition. If PAUSE is active, recording can start with a one button PLAY command.

24 RECORD Status Indicator

The red LED blinks when the deck is in Record Ready mode and lights up in the Record mode.

25 PAUSE Status Indicator

The green LED lights only when PAUSE and RECORD have been simultaneously pressed.

26 Shut Off Arm

The shut off arm will drop power to the capstan and reel motors if the tape breaks. It's a good idea to allow it to drop when you take a break in the middle of a session. Doing this will stop the constant rotation of the capstan, and will lengthen the life of the capstan motor bearings. It is not necessary to unthread the tape. Just allow it to become slack so that the shut off arm can drop.

27 MICrophone Input

1/4" phone jack accepts unbalanced signals from any type of microphone having any impedance from 150 ohms to 10,000 ohms. If you are using balanced professional mics, use #109B adaptor to connect it to the MIC IN jack.

Why use a transformer if it is not absolutely necessary? There may be a good reason, and it applies primarily to mics used with cable runs exceeding 10 feet. The low power signal that mics (and some instrument pickups) generate must frequently be protected and isolated from other low power signals. Radio, power line hum, buzz, crackles and switching noise when motors start up (do you have an air conditioner on your AC line or maybe an old fridge?) – all these unwanted signals must be kept out of the very high gain amplifiers that are needed to raise the mic signal to a working level. The balanced or three-wire mic circuit and input isolation transformer are the only sure way to deal with the problem. Here's how it works:

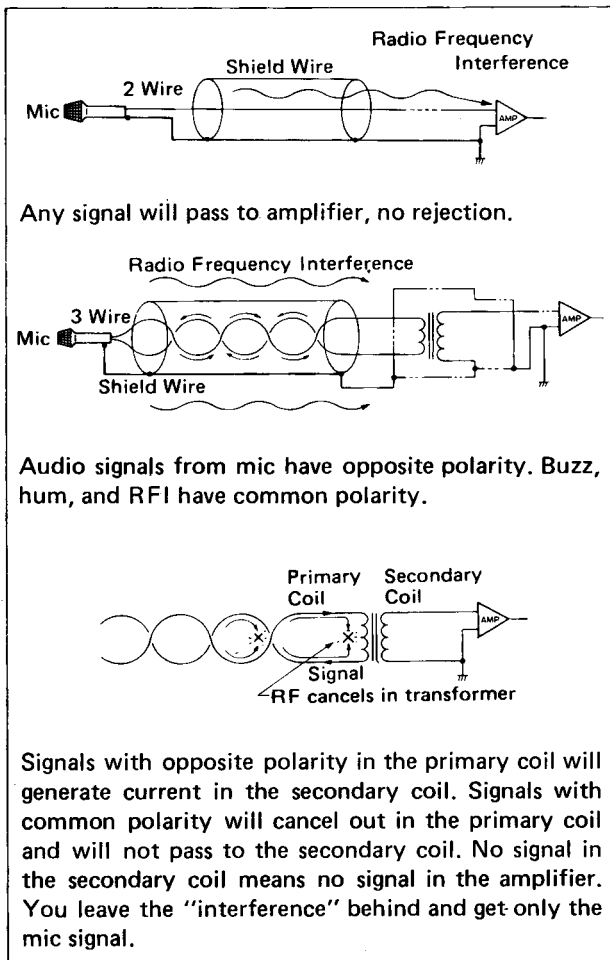

28 MIC ATTenuator

The two position switch selects either a 0 dB or a -20 dB attenuator. This 20 dB attenuator (pad) is used to reduce the level of extremely "hot" mic signals.

29 LINE IN Jacks

Nominal input level is -10 dB (0.3 V). Input impedance is 50 k ohms (unbalanced).

30 OUTPUT (Line Out) Jacks

Nominal output level is -10 dB (0.3 V). Minimum load impedance is 10 k ohms (unbalanced).

31 DBX UNIT CONTROL SIGNAL Connector

This allows connection of the DX-4D NOISE REDUCTION SYSTEM and supplies control signal to the dbx system to permit simultaneous encode/decode dbx operation. Because of this "dual process", no switching is required when you change function from recording to playback. The fact that there are separate sections for each function will also allow "off-the-tape" monitoring when dbx is used.

32 REMOTE Connector

Allows connection of the optional RC-71 Remote Control Unit.

33 PUNCH IN/OUT REMOTE Connector (RC-30P)

Allows connection of the optional RC-30P TASCAM PUNCH IN/OUT REMOTE PEDAL.

BASIC INFORMATION

Reel Installation Small Hub Reels

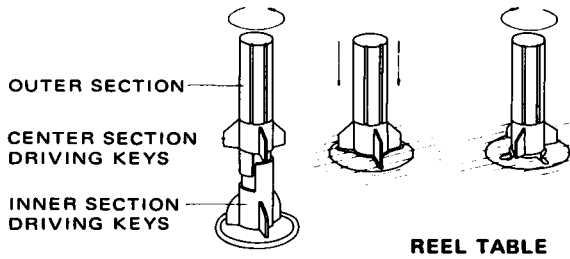

Large Hub Reels

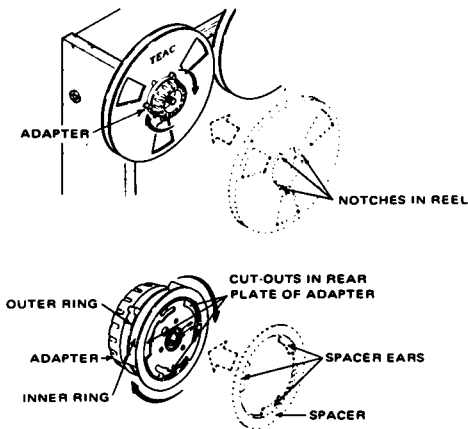

NOTE:

A metal spacer is mounted on the back of the reel adaptors and it must be in place when NAB standard 10-1/2" metal reels are used.

Head Configuration

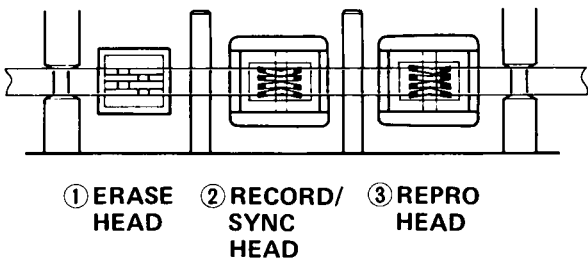

Threading the Tape

Lift the head access cover and release the sync head shield to gain access for threading.

NOTE:

If you use a reel of tape that has been stored "tailed out" (See "Editing and Tape Storage"), it must be placed on the right reel table and rewound to the left.



Erasing the Tape

A previously recorded tape is automatically erased when you make a new recording on it. For the best-quality recordings and for convenience, we recommend the TEAC E-2A bulk eraser. This will erase your tapes cleanly in one pass for the best signal-to-noise ratio. Another way to erase is to record with the input controls set to the minimum levels.

Editing and Tape Storage

Never use ordinary adhesive tape for this vital procedure. Use only the special tape made exclusively for tape editing.

Monitor with the CUE lever. When you have located the precise point to make the cut, stop the tape and mark the back of the tape with a Chinacraft type pencil at the center of the reproduce head, and then use the EDIT switch. With the EDIT switch and (▶) button depressed, the tape will begin unthreading itself (dumping) because the take up reel will not be moving to take up the slack. The use of non-magnetic tools is highly recommended. A good quality machine-milled tape-editing block will help ensure good edits.

Tape should be stored in a cool, dry place well away from the influence of magnetic fields. Print-through (the unwanted transfer of magnetic signals from one part of the tape to an adjacent part of the tape, causing "echos") may be reduced by winding (NOT fast winding) the tape onto the take up reel at normal playing speed for storage. When the tape is played again, it is first rewound at a high speed onto the supply reel. This is called storing the tape "tails out" and is a common practice in many studios. A helpful idea is to use white leader tape at the beginning and red leader tape at the tail end. The analogy with vehicle head and tail lights is then an easy way to remember which end is which.

CLEANING

IMPORTANT:

Do not overlook the importance of cleaning. Insufficient cleaning is the number one cause of the degradation of performance levels.

The first thing you will need for service is definitely the least expensive — Cleaning fluids and swabs. The whole outfit, 2 fluids and all the cotton swabs you'll need for months cost less than one roll of high quality tape. We can't stress the importance of cleaning too much. **Clean up before every session. Clean up after every session. Clean up every time you take a break in the middle of a session (we're serious).** How come? Well there are two good reasons we can think of right off the top:

1. Any dirt or oxide buildup on the heads will force the tape away from the gaps that record and playback. This will drastically affect the response. Even so small a layer of dirt as one thousandth of an inch will cause big trouble. All the money you have paid for high performance will be wiped out by a bit of oxide. Wipe it off with head cleaner and get back to normal.
2. Tape and tape oxide act very much the same as fine sandpaper. The combination will grind down the tape path in time. If you don't clean off this abrasive on a regular basis, the wear will be much more rapid and, what's worse, it will become irregular. Even wear on heads can be compensated for by electronic adjustments for a time, but uneven wear can produce notches on heads and guides that will cause the tape to "skew" and skip around from one path to another, making adjustment impossible. This ragged pathway chews up the tape, thus dropping more abrasive, thus causing more uneven wear and so — a vicious spiral that can't be stopped once it gets a good start. The only solution will then be to replace not only the heads, but all the tape guides as well. Being conscientious about cleaning the tape path on the 34B will more than double the service life of the head assembly.

ENTERING "RECORD"

DEGAUSSING (DEMAGNETIZING)

IMPORTANT:

1. Do not overlook the importance of degaussing. Magnetism in the tape can significantly degrade performance. In extreme cases, the heads may not respond to signals at all.
2. Turn off the deck before degaussing.
3. Do not turn the degausser (E-3) off or on while it is in close proximity to the tape path.
4. Keep all recorded tape a safe distance from the degausser.

A little stray magnetism goes a long way. A long way towards making trouble for your tapes. It only takes a small amount (0.2 gauss) to cause trouble on the record head and playing 10 rolls of tape will put about that much charge on the heads and other ferrous parts of the tape path. A little more than that (0.7 gauss) will start to erase high frequency signal on previously recorded tapes. Demagnetize the whole tape path, including the tips of the tension arms every six fully played 10-1/2" reels. This is a fair "rule of thumb" even though it may be a bit hard to keep track of. Fast motion isn't as significant to the heads, so we don't give an hourly reference. It's the record/play time that counts.

Degaussing is always done with the recorder turned off. If you try it with the electronics on, the 60 cycle current pulses produced by the degausser will look just like 60 Hz audio to the heads, at about 10,000 VU and will seriously damage the electronics and/or the meters. Turn off the machine, turn on the degausser at least 3 feet away from the recorder. Move slowly in to the tape path. Move the degausser slowly up and down in close proximity to all ferrous parts and, slowly move away to at least 3 feet before turning off.

It's a good idea to concentrate when you are degaussing. Don't try to hold a conversation or think of anything else but the job you are doing. If the degausser is turned off or on by accident while it is near the heads, you may put a permanent charge on them that no amount of careful degaussing will remove — head replacement time again, we're sorry to say. Make sure you are wide awake for this procedure.

A clean and properly demagnetized tape recorder will maintain its performance without any other attention for quite some time. Even if it does drift as a recorder, it won't ruin previously recorded material, and getting it back in good shape will not be too difficult.

OUTPUT SELECT BUTTONS: The signal presented at the output terminals is controlled by the OUTPUT SELECT buttons.

INPUT will typically be used for source calibrations during system interface and set-up procedures. When this button is depressed, the input signals are sent directly to the output terminals.

REPRO will present the reproduce head signal to the output jacks for those situations where it is desirable to monitor the printed signal on the tape for reference during the recording.

SYNC will be used for most operations: recording, overdubbing (sync), and reproduce. The monitoring status is then determined by the FUNCTION SELECT buttons.

FUNCTION SELECT Buttons. When the OUTPUT SELECT is in either the INPUT or REPRO position, the FUNCTION SELECT buttons have the single purpose of determining the record status. OUT is safe. IN is ready-to-record.

When the OUTPUT SELECT is in the SYNC position, the FUNCTION SELECT buttons serve two purposes: (1) they determine the record status — OUT is safe, IN is ready-to-record and (2) they determine the monitoring status — OUT is sync/tape reproduce; IN is source.

There are 3 ways to enter record:

1. RECORD/PLAY

With the OUTPUT SELECT in the SYNC position, depress the FUNCTION SELECT Switches for those tracks on which you wish to record. The LEDs will indicate ready-to-record on those particular tracks. Enter record with the TRANSPORT CONTROLS – depress RECORD (red LED lights) and PAUSE (green LED lights) together. Then push (▶) and the selected FUNCTION SELECT LEDs will remain lit until released.

	FUNCTION SELECT		TRANSPORT CONTROLS		OUTPUT
	Switch	LED	RECORD/PLAY	LED	
Safe	out	off	–	off	Tape
Ready	in	blinks	–	off	Input/Source
Record	in	on	engaged	on	Input/Source

2. FUNCTION SELECT

This method should be used when it is necessary to hear a previously recorded signal up to the “punch-in” point. If the FUNCTION SELECT Switches are OUT (safe) the tape signal will appear at the output and the PHONES SELECT Switches. If the FUNCTION SELECT Switches are IN (record ready), only new INPUT signal can be auditioned and listening to the tape to find a “Cue” point for the punch-in will not be possible. When you must listen to the tape, preload the record logic and the FUNCTION SELECT Switches to begin the recording.

First set the FUNCTION SELECT Switch in

the out position and enter record with the RECORD and (▶) buttons. Now the record LED will blink, indicating ready-to-record, and you are monitoring sync/tape reproduce. At the appropriate time, depress the FUNCTION SELECT Switch(es) for the tracks you wish to punch-in, and you enter record while simultaneously switching the monitor to source. The record status indicator will now stay on instead of blinking.

Now, imagine two different occasions where it is desirable to punch-in a correction on a given track, instead of recording the entire part all over again.

	FUNCTION SELECT		TRANSPORT CONTROLS		OUTPUT
	Switch	LED	RECORD/PLAY	LED	
Safe	out	off	–	off	Tape
Ready	out	off	engaged	blinks	Tape
Record	in	on	engaged	on	Input/Source

EXAMPLE 1:

If the correction needs to be made at the BEGINNING — say a hesitant start that is slightly out of sync with the cue/downbeat — then there is no need to monitor reproduce (sync) since the bad start will only serve to confuse the talent.

So the punch-in is straightforward enough: enter the record mode on the appropriate track with the corresponding FUNCTION SELECT Switch. Press the record and (▶) button when the cue/slate occurs — at the beginning of the tune — then enter stop at a convenient, appropriate time, after the punch-in is completed.

EXAMPLE 2:

In this situation, suppose an error has been made near the end — or in the middle — the example 1 is still valid. Now the talent will likely need to hear his performance up to that point so that the punch-in does not represent a different style or feel, and therefore, is consistent with the rest of the performance. In this case, enter record ready by pressing the record and play buttons simultaneously. The record mode will be activated when a FUNCTION SELECT Switch is depressed.

When the FUNCTION SELECT is in the out position, the talent will be monitoring reproduce (sync) and probably play along with the previous performance until the time comes to punch-in the correction. When that moment occurs, simply press the appropriate FUNCTION SELECT Switch for the corresponding track that is ready to be recorded. Two things then happen. First, you instantly enter the record mode on that track, and the new part will replace the previous one, in sync of course. Second, the monitor is automatically switched from tape (out position) — sync reproduce — to source (in position) — so the talent can hear his new part as it is being added. The logic remains consistent.

3. PUNCH IN/OUT OPERATION WITH THE RC-30P REMOTE PEDAL.

An accessory pedal is available that will allow you to start recording with a foot switch. This is extremely useful to the talent who must make a “right” punch-in that requires both hands “on the instrument” at the exact moment of the “punch”. The foot switch will NOT start the transport, you must do that, but it WILL start and stop recording. Here’s How.

Connect the TASCAM PUNCH IN/OUT REMOTE PEDAL to the rear of the 34B. Now, even with both of your hands occupied, PUNCH OUT can still be performed by using the remote pedal. While in sync reproduce, pressing the pedal with your foot initiates punch-in of the channels for which record function has been selected. Punch-out is done by simply pressing the pedal again.

BASIC CONNECTION AND HOOK-UP

Connection of the 34B is actually fairly straightforward. Integrating a multitrack recorder with the studio mixer, various patch bays or other effects devices can be confusing, and while there is no absolute correct answer, here are some guidelines.

The connection of a four track recorder to a console remains somewhat consistent. Every console has primary line (buss) outputs and these are going to connect to the line inputs of the multitrack recorder. This will enable the input channels of the console to be assigned (grouped on the busses) to the recorder for basic tracking. Of course, mixdown is also an essential function and this is where confusion sometimes appears. Initially it is easy to use the line inputs of each mixer channel for tape playback (return). TASCAM has provided separate tape return inputs on many of our mixer designs, which greatly enhances flexibility by leaving the standard console line level inputs available for recording inputs.

A COMMENT ON PATCHING

Most people tend to look for permanent connections in order to reduce complex patching logic to something that can be dealt with "under pressure." It is true that the logic of the control functions on the top panel takes some time to become familiar with, but multi-channel production has many mixing requirements. A permanent patch will severely restrict flexibility. If you can learn to examine the system with re-patching in mind, you can achieve significant improvements in system performance. For this reason, we suggest that you plan on access to the back panel of the mixer. Don't set up your system in such a way that you "hide all that mess" and have no access to the back panel. Leave yourself room to get at all the connectors. You will need all the options you can get.

After you have made several patches you may find that the top panel labels are no longer correct, and so we strongly suggest that you take the time to re-label each control to correspond to the new function that your re-patch is controlling. Drafting tape labels applied to each control or group will prevent accidents from happening because you have tried to operate the mixer "normally."

It is also wise to label both ends of every cable. When repatching away from "normal", a label will save endless tracing and re-tracing of the wiring.

In all patching and connecting of two-wire single ended circuits, some basic rules are worth mentioning:

Keep your cable runs SHORT! — as short as possible.

Installing a patch bay behind the engineer's chair will require at least 20 foot cable runs out and back and is not recommended.

Mounting the patch bay on the left or right side of your mixer will allow much shorter runs. Incidentally short runs cost less so you will save money as well.

Try to develop the ability to look at your equipment with an eye toward a specific solution for the problem at hand. Layout your equipment to match your work style and facilities. Ultimately you will grow to know your equipment better, discover new uses, and most likely become a better engineer as you learn.

BASIC HOOKUP AND CALIBRATION OF THE RECORDING SYSTEM

Calibrating the 34B is simply the process of matching its output to the rest of the equipment. In this example, we will assume you are using a 4 buss mixer. The method we use here can be used with virtually any type or combination of equipment you are likely to encounter.

The first step is to connect the outputs of the console to the LINE INPUTs of the recorder. The recorder LINE OUTPUTs should be connected to the tape return or line inputs of the console. If you are using a console with an operating level of +4 dBm with XLR connectors, TASCAM has a solution in the form of the LA-40. Please refer to page 24 for more information on this device.

The basic procedure is very simple if you have a tone generator of some kind (TEAC TO-122A).

- 1) Set the Test Tone Oscillator to 1,000 Hz (1 kHz) and plug it into an input on your mixer.
- 2) Set the pan to 12 o'clock and bypass or defeat the EQ, assign the output busses.
- 3) Raise the channel fader to the nominal level and raise the buss faders to indicate 0 VU on the console's meters.
- 4) Set the 34B INPUT SELECT switches to LINE. Set the INPUT controls on the recorder to 0 VU on the recorder meters (this should be approximately on the "CAL" position). Zero the tape counter.
- 5) Place the deck in Record and record the 0 VU tone for a minute or two. While the tape is rolling, depress the REPRODUce switch to switch to reproduce. Set the OUTPUT control to 0 VU.
- 6) Engage the zero return. Rewind the tape (it will stop at approximately "0000"). Disconnect the original tone source and set your console to the tape return or line inputs. Play the tape; this will provide a constant tone source and the faders should again be near the nominal position for an indicated "0 VU" on the console meter.

NOTE: If you own a playback reference tape, this method can be altered slightly by starting with the recorder in playback. The test tape can be used as your tone source to establish nominal console fader positions. The procedure is as follows:

- 1) Play the tape.
- 2) Set the OUTPUT controls on the 34B to 0 VU. This should be approximately "CAL" on the output dial scale.
- 3) Switch the mixer to tape or line input on the channels connected to the recorder.
- 4) Set your mixer input faders and buss faders to 0 VU on the console meters.
- 5) Switch the tape recorder to INPUT.
- 6) Adjust recorder INPUT controls to 0 VU on recorder's meters. This should be approximately the "CAL" position.

Note: Please do not engage record mode during this procedure or you will erase your expensive reference tape.

34B

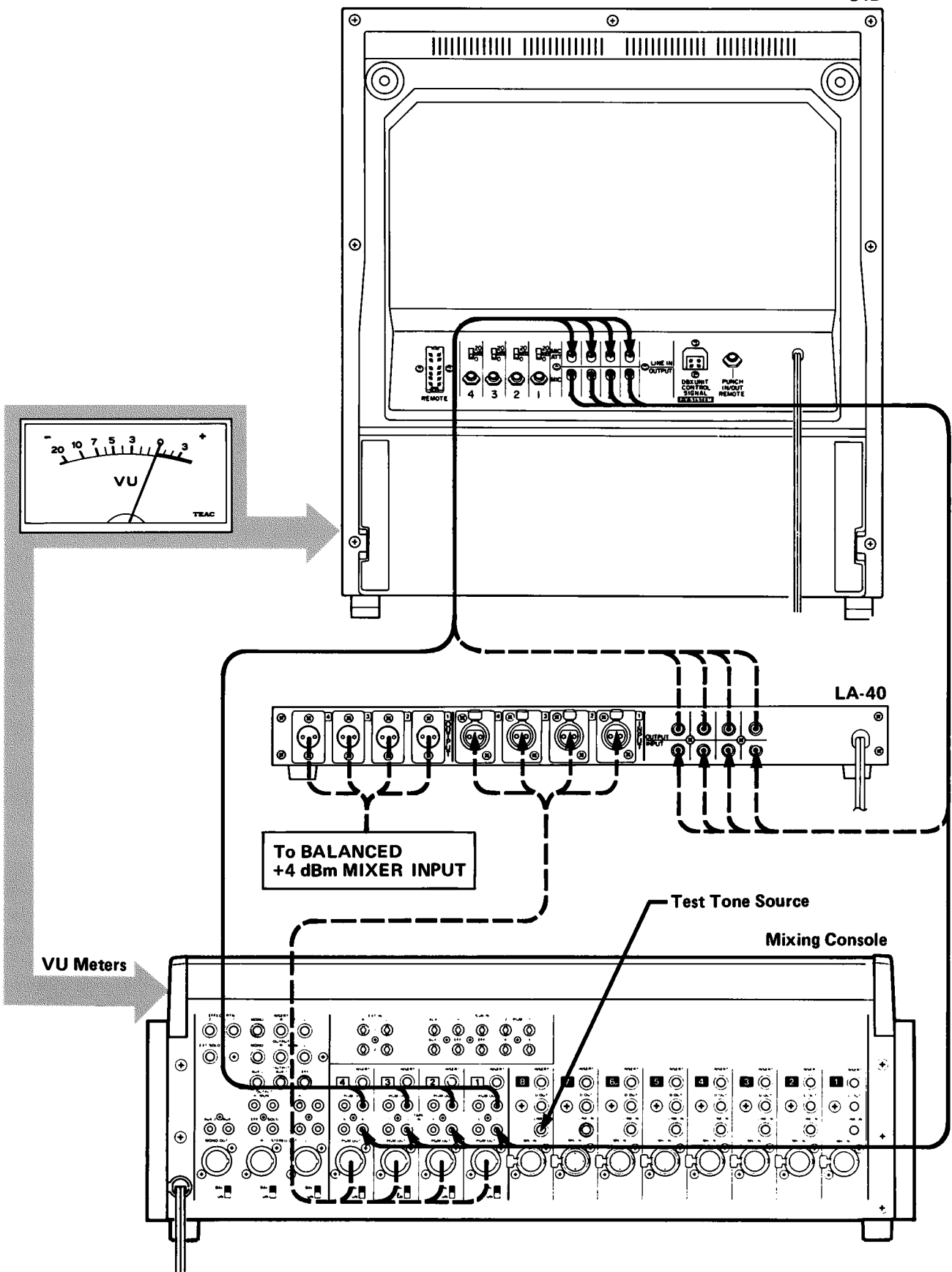

WHAT IS SIMUL-SYNC?

On a tape recorder the Record and Playback heads are some distance apart. If you record something, the actual replay occurs a second or so later when the tape reaches the Playback head. Under normal circumstances this isn't a problem but if you wanted to record something and make a second recording in sync with the first, you'd find it impossible. This is because the point on the tape that you would be listening to and the point where the recording was taking place would not be the same and therefore create a time lag. By building a combined Record and Playback head, it's possible to monitor and record at exactly the same point on the tape, hence the term Simultaneous Synchronization or Simul-Sync.

The solution is to record new material while monitoring previous recordings at the same point. This is what simul-sync does. The record head is temporarily switched to function as a playback device. (You cannot do both simultaneously on the same track. Simul-sync provides a choice of either recording or playback).

With an understanding of how Simul-Sync functions, come a number of new techniques, advantages and some operating hints.

It is now no longer necessary to record everything at the same time. Recording can be done on a convenient schedule and with much more flexibility. This means that isolation can be better. Talent can perform individually in the studio.

Additionally since maybe only one mic is "live" at a given time, an investment can be made in one really high quality mic, that can be used on each track, to significantly upgrade the overall sound quality.

Another technique that becomes available is known as ping-pong or collapsing tracks in order to further expand the capabilities of your equipment. Simply put, to collapse tracks record both tracks 1 and 2, then play them back and mix them together which is then re-recorded on track 4. Additional parts could also be added through the mixer at that line, so you can end up with many parts combined onto track 4 of the recorder. This method does require planning and forethought on the part of the operator of course, since once all the parts are combined,

they cannot be individually adjusted, altered, or redone in any way without repeating everything. (The use of a track chart in planning the production is of great value.)

Some basic rules and notes apply to ping-pong operation. It is quite common to hear crosstalk in simul-sync or ping-pong use. This is not critical for this crosstalk does not print on the tape, it is present in the electronics only. It is also good practice to avoid a ping-pong to an adjacent track, for this requires actual adjacent tracks on the Record (simul-sync) head to be performing the functions of Record and Play at the same time. It is far better to maintain a guard track between the playback and record channels (ie: 1 & 2 to 4, not 2 & 3 to 4).

If a situation arises where this becomes unavoidable, it is of great help to record the basic track at high levels so that when they are combined, the playback can be very low and still provide adequate signal to be recorded in combination.

MONITOR METHODS

When used with a mixer the multitrack recorder becomes a powerful tool for production and recording. Together, they form the foundation on which you will build your work or presentation. With this consideration in mind, it is valuable to consider a procedure that is a very valuable method to save time and improve efficiency. We at TASCAM strongly recommend a monitoring system whereby playback through tape electronics is employed on a regular basis.

Monitoring is among the most important facilities a mixer can provide. TASCAM has expended great effort to develop affordable mixer designs with comprehensive monitoring facilities. In fact, the monitor functions are really a separate sub-mixer included within the mainframe. TASCAM mixers typically provide full independent monitor facilities equivalent to the number of tape returns. Other manufactures of PA type mixers depend on the input channels for monitoring.

Establishing your monitor mix from the recorder tape returns (playback as normal procedure solves the problem of "where is the signal coming from?" It is no longer important to remember which console input is assigned to track 4, just listen to track 4 and you hear what's on tape. With this method, any line level signal becomes a track feed, even if you can't monitor it "on the way out," because you will be monitoring the return, not the send. This method will also immediately show up any glitch in the recording system, tape dropouts or other problem so you know whether you have a good "take" and don't discover it later when the talent has left for the day. Another advantage of this method is that no console changes are required to provide a playback for the talent or producer to audition. Since you are already listening to "playback," just rewind and play the tape. This is a great timesaver.

CONNECTION AND OPERATION OF THE DX-4D

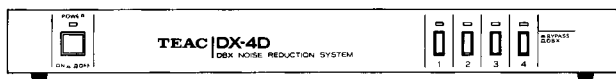

The 4 channel DX-4D dbx Noise Reduction unit has been designed to be used with the 34B and other TASCAM 4 and 8 channel reproducers. The DX-4D is a dual process design, capable of simultaneous encode and decode of 4 channels of audio. The function of each channel is automatically controlled so that non-encoded signals are always available at the outputs of the DX-4D.

The DX-4D, as with all other TASCAM dbx units, will only function when connected to a TASCAM unit. They have been designed to operate as a system and function automatically. Once they have been connected they become an integral part of the 34B. There is no need for record or reproduce calibration or level adjustments for the unit. There will however need to be some adjustments in your recording technique. After you have connected the DX-4D to your 34B you will find that the meters will read at a lower level with the dbx engaged than without it. This is because the meters are displaying the encoded signal level (after compression), and looking at reduced levels on the meters may take some getting used to. DO NOT attempt to adjust the input and output levels of the 34B to reflect 0 VU with the dbx engaged as this elevated level will induce decoding errors.

Always calibrate your mixer and 34B with the dbx in the bypass position. This will insure optimum performance of the system. Following these environmental guide lines will also help to insure quality performance of your system.

- * Avoid temperatures beyond the range of 5°C to 30°C (40°F to 87°F).
- * Avoid using AC power inputs that fluctuate greatly.
- * Avoid areas where there is extremely high humidity.
- * If the surface of the unit gets dirty, wipe with a soft cloth or use a diluted neutral cleaning liquid. Clean off thoroughly. Do not use thinner, benzine or alcohol as they may damage the surface of the unit.

HOOK UP

Connecting the DX-4D to the 34B is very straight forward.

1. Connect the Control Signal cable of the DX-4D to the DBX UNIT CONTROL SIGNAL jack on the 34B.
2. Using 4 cables connect the ENCODE OUT jacks to the 34B LINE INPUT jacks.
3. Using 4 cables connect the 34B OUTPUT jacks to the DX-4D DECODE IN jacks.
4. Connect your mixer buss (group) outputs to the DX-4D INPUTS.
5. Connect the OUTPUTS of the DX-4D to the Line-In or Tape-In connectors of your mixer.

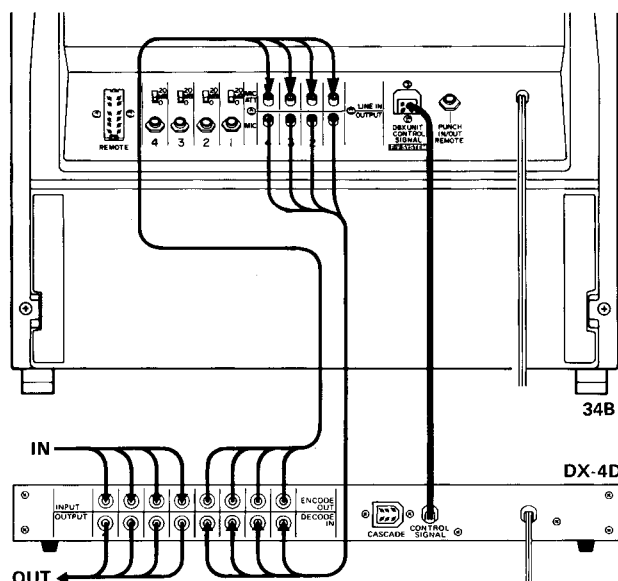

POWER Switch

When depressed (ON), the LED above lights. Press again (OFF) to turn off.

DBX/BYPASS Switches

These switches allow you to control the function of each channel.

DBX — () position: the LED is on and the dbx circuits are engaged.

BYPASS — () position: the LED is off and the dbx circuits are disengaged, not in the audio path.

Note: Use the BYPASS position when you are playing back tapes which have not been recorded with dbx or when you are recording and working with individual tracks containing time code or control code information.

ACCESSORY INFORMATION

RC-71 Remote Control Unit

The RC-71 is designed for remote control of the transport functions.

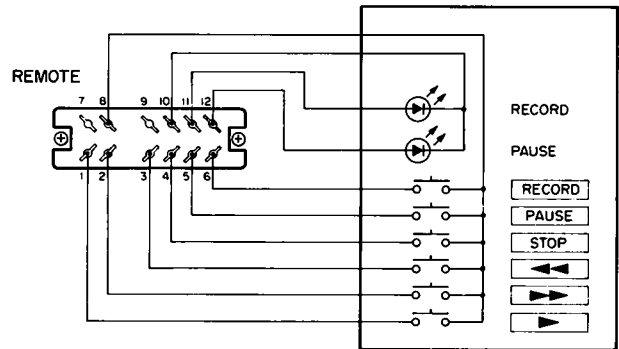
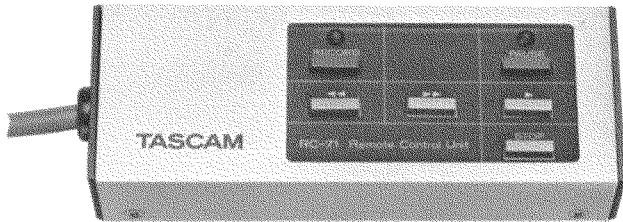

RC-30P Punch In/Out Remote Pedal

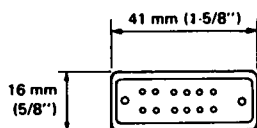
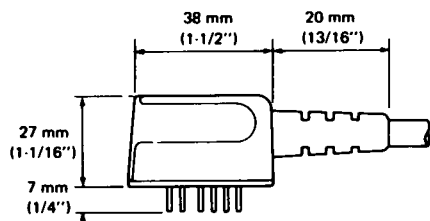
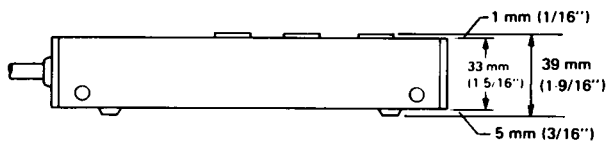
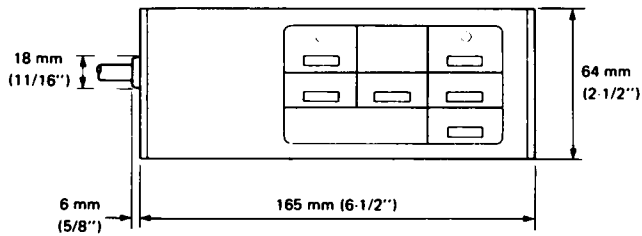
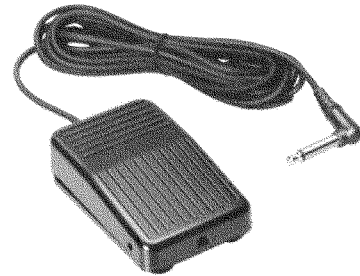

CS-607B Console Rack (EIA 19-inch)

The CS-607B is a standard 19-inch console rack to be used with the RM-300 for mounting of the TASCAM 34B.



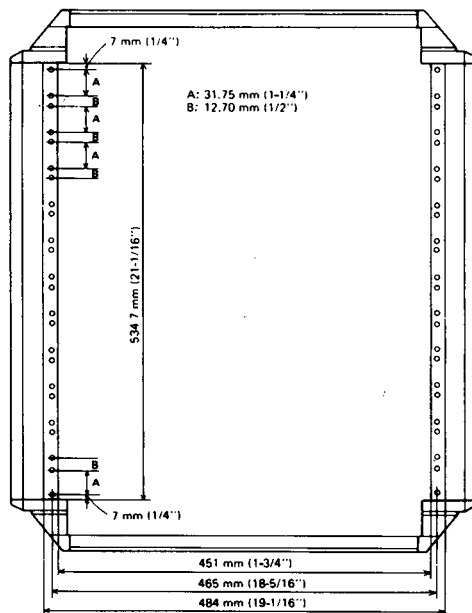
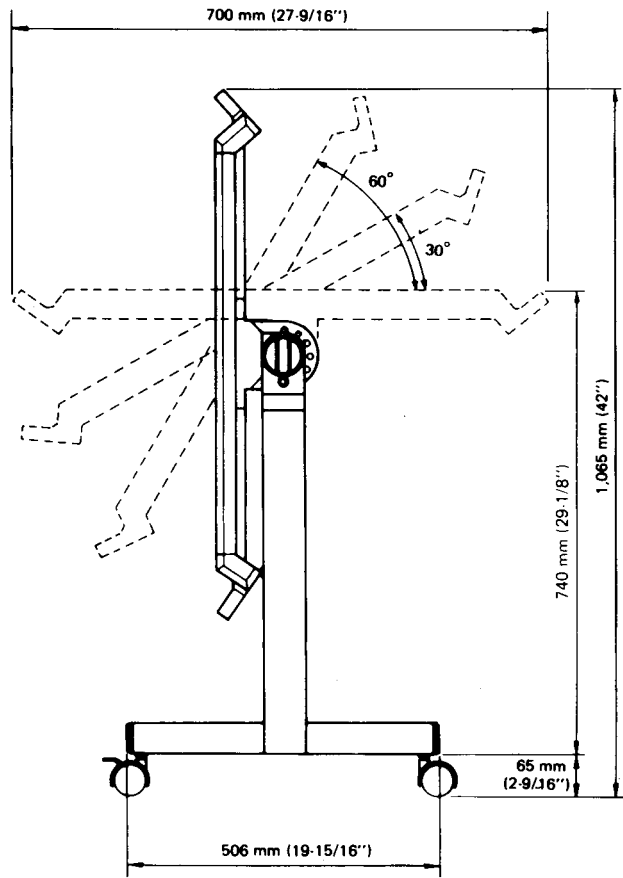
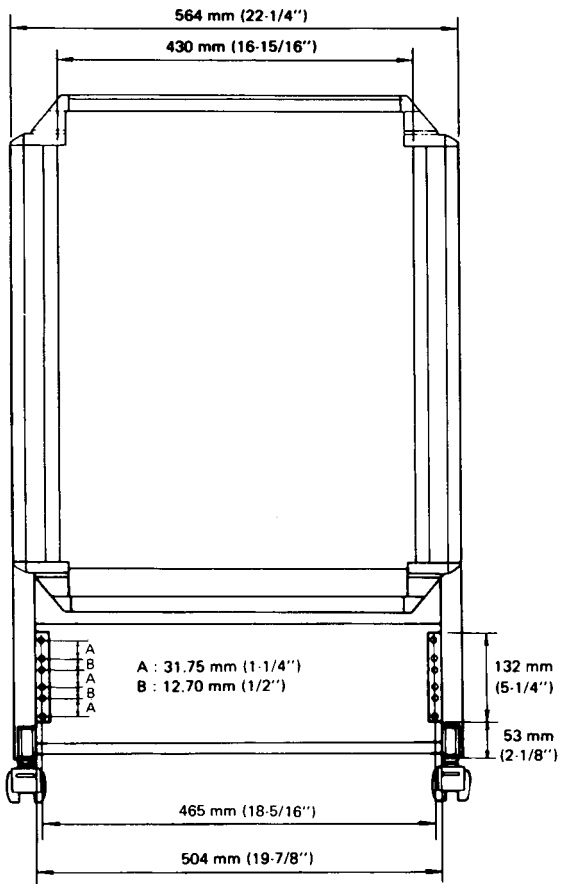

RM-300 Rack Mount Angle (EIA 19-inch)

The RM-300 is a rack mount angle kit for the TASCAM 34B recorder/reproducer to enable mounting in the CS-607B, or an equivalent 19-inch rack.

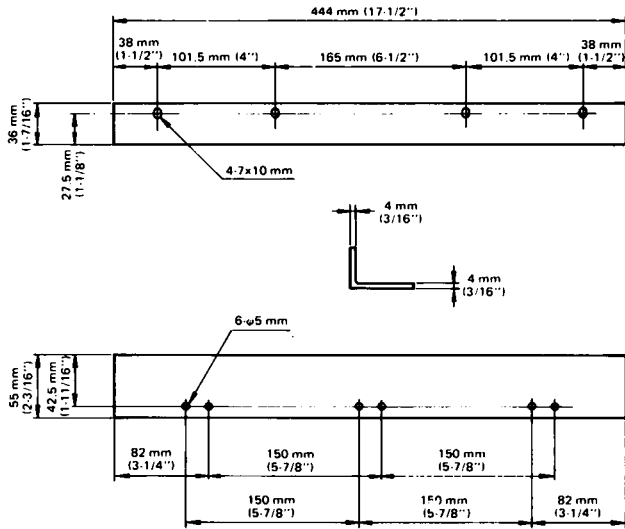

T-0804 Blank Panel (EIA 19-inch)

The T-0804 is designed to cover up the unavoidable blank spaces on the TASCAM CS-607B, or equivalent EIA standard 19-inch rack.

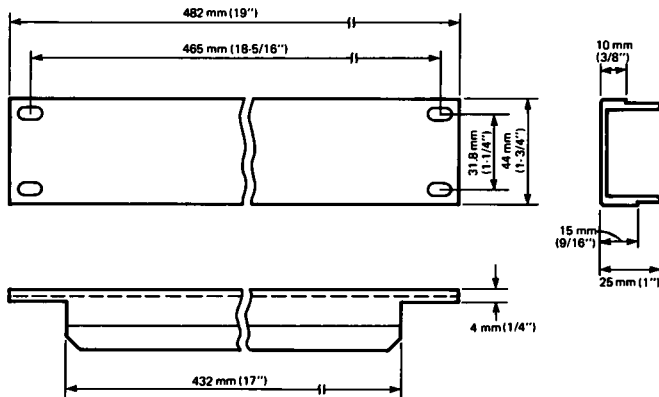

TO-122A Test Tone Oscillator

Checks input/output balance or other electric characteristics of the system chain. This unit is also useful for tape deck maintenance work.

- *Output pin jack
- *Output level -10 dB, -40 dB (0 dB/1 V)
- *Selectable frequencies 40 Hz, 400 Hz, 1 kHz, 4 kHz, 10 kHz, 15 kHz

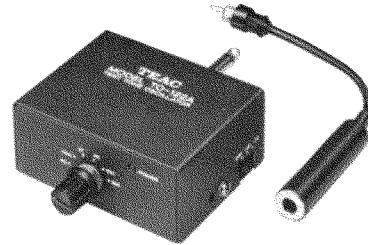

E-3 Head Demagnetizer



E-2A Bulk Eraser

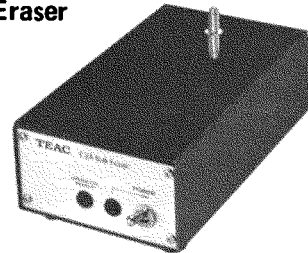

RE-1004 Reel (10-1/2", 1/4" tape)

RE-712 Reel (7", 1/4" tape)



LA-40 Low Impedance Adaptor



The LA-40 is a 4-channel low impedance adaptor which makes it possible to connect 600 Ω balanced +4 dBm/-20 dBm XLR type connectors or 3-conductor 1/4" phone jacks to -10 dBV RCA pin jacks, or vice versa.

PB-64 Patch Bay

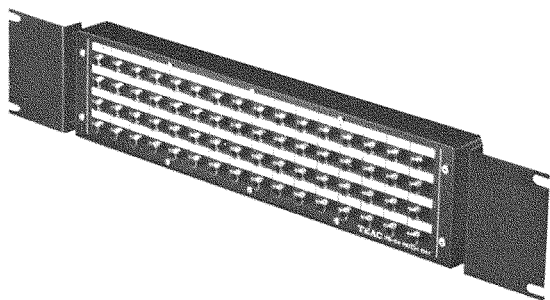

A tangle of cables is one of the growing vexations of any audio system. With all of the inputs and outputs plugged into the rear panel, jumper cables plugged into the front make any hookup you need neatly.

PB-32 Patch Bay

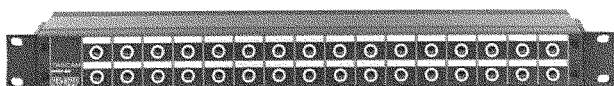

The PB-32 patch bay is today's simplest and most effective way to deal with the ever-increasing tangle of wires necessary for the recording and signal processing you want to do. Instead of leaning over, walking around, or turning consoles, racks, recorders and other equipment, you can bring all those confusing cable ends to one single spot in your rack, or next to your mixer, and get them under control. You can label inputs and outputs on the PB-32, and won't have to guess anymore at what you might be plugging in. A few cords can save endless hours of searching around on the floor behind your console and, as the whole process of patching is made simpler, you'll probably find more flexibility in your recording setup.

The PB-32 comes in four versions. The PB-32P is equipped with 1/4" phone jacks only, the PB-32R with RCA jacks only, the PB-32H with 1/4" phone jacks on one side and RCA jacks on the other, and the PB-32W with 1/4" phone jacks for 6 channels and RCA jacks for the remaining 10 channels.

Professional Low Loss Cable

There are vast differences in cable design and performance, and those differences can make or break an otherwise excellent sound system. When you're investing in the kind of high quality audio equipment represented by the TASCAM Studio Series, it makes sense to use TASCAM professional audio cables. Anyone who's switched to them will tell you they're worth every cent.

LOW CAPACITANCE

Our cables feature very low capacitance under 15 picofarads per foot, so they don't act as high-frequency roll-off filters as do typical cables of 100 or 300 pF/foot. In addition, our cables use an ultra-high density bare-copper braided shield (99 % coverage), so electrostatic noise (buzz or hum) and RFI (CB or broadcast signals) are kept out of your program.

Low capacitance is important, and so is consistent capacitance; that is, you want the electrical coupling of center conductor-to-shield to remain the same throughout the cable, even if it is sharply bent, crushed, flexed, or tugged. Should the local cable capacitance change, noise and/or signal losses often result. We utilize the unique dielectric known as Datalene. This special insulation keeps the stranded signal conductor perfectly centered within the shield. Datalene is about as flexible as foam core dielectrics but far more resistant to extreme heat or cold, and it has a "memory", so it retains its shape after flexing. Datalene also acts as a mechanical shock absorber, guarding against external impacts which, in other cables, might sever the center conductors and cause intermittent contact.

When we join the connector to the cable, we insert the cable's stranded center conductor all the way into the pin and then fill the pin with solder. The braid is wrapped and soldered a full 120° around the shell, not tacked at one spot, so you get maximum shielding and strength.

VOLTAGE CONVERSION

This deck is adjusted to operate on the electric voltage specified on the power cord and packing carton.

Note: This voltage conversion is not possible on model sold in the U.S.A. and Canada, UK, Australia or Europe.

For general export units, if it is necessary to change the voltage requirements of this deck to match your area, use the following procedures. Always disconnect Power Line Cord before making these changes.

1. Disconnect the power cord of the deck from the source.
2. Remove the bonnet panel and locate the voltage selector on the side of the deck.
Refer to "2-2 Removing the Panels of the Deck" on page 63.
3. To increase the selected voltage, turn the slotted center post clockwise using a screwdriver or another suitable tool.
4. To decrease the selected voltage, turn the slotted center post counter-clockwise.
5. The numerals that appear in the cut-out window of the voltage selector indicate the selected voltage.
6. If the desired voltage numerals do not appear in the cut-out window as you turn the slotted center post, your deck must be taken to an authorized TEAC Service Facility for voltage conversion.

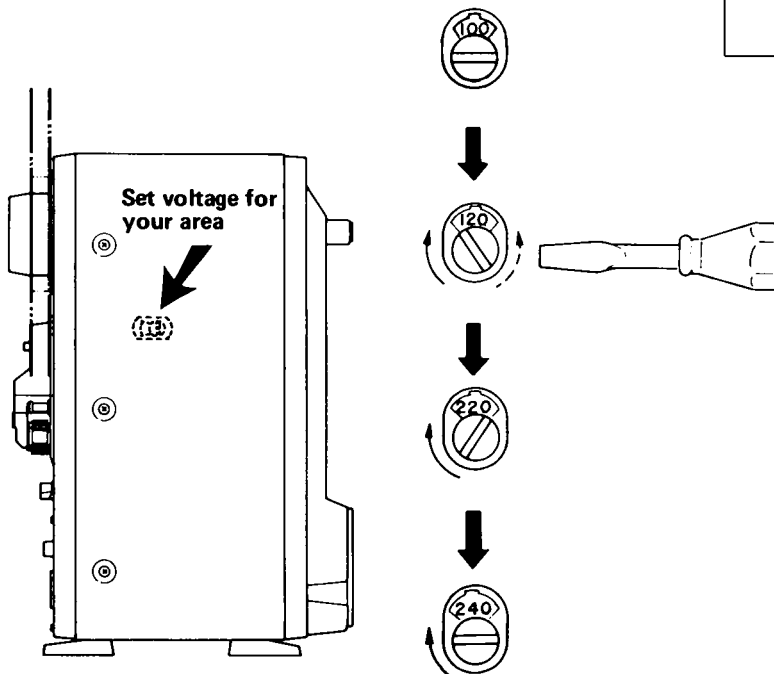

NOTE FOR U.K. CUSTOMERS

U.K. Customers Only:

Due to the variety of plugs being used in the U.K., this unit is sold without an AC plug. Please request your dealer to install the correct plug to match the mains power outlet where you unit will be used as per these instructions.

IMPORTANT

The wires in this mains lead are coloured in accordance with the following code:

BLUE: NEUTRAL
BROWN: LIVE

As the colours of the wires in the mains lead of this apparatus may not correspond with the coloured markings identifying the terminals of you plug, proceed as follows.

The wire which is coloured BLUE must be connected to the terminal which is marked with the letter N or coloured BLACK. The wire which is coloured BROWN must be connected to the terminal which is marked with the letter L or coloured RED.

THE APPLIANCE CONFORMS WITH EEC DIRECTIVE 87/308/EEC REGARDING INTERFERENCE SUPPRESSION

CONFORME AL D.M. 13 APRILE 1989
DIRETTIVA CEE/87/308

SPECIFICATIONS OF THE 34B

MECHANICAL

Tape:	1/4 inch, 1-1/2 mil, low noise, high output tape
Track Format:	4-track, 4-channel, track width, 0.036 inch (0.91 mm)
Reel Size:	10-1/2" NAB (large) Hub maximum
Tape Speeds:	15 inches per second (38 cm/sec), 7-1/2 inches per second (19 cm/sec); Variable, $\pm 12\%$ relative to 15 ips/7-1/2 ips $\pm 0.8\%$ deviation
Speed Accuracy:¹⁾	
Wow and Flutter:¹⁾	
15 ips	$\pm 0.06\%$ peak (DIN/IEC/ANSI weighted) $\pm 0.1\%$ peak (DIN/IEC/ANSI unweighted) 0.05 % RMS (JIS/NAB weighted) 0.07 % RMS (JIS/NAB unweighted)
7-1/2 ips	$\pm 0.09\%$ peak (DIN/IEC/ANSI weighted) $\pm 0.12\%$ peak (DIN/IEC/ANSI unweighted) 0.07 % RMS (JIS/NAB weighted) 0.09 % RMS (JIS/NAB unweighted)
Fast Wind Time:	90 seconds for 10-1/2" reel 2,400 feet
Start Time:	Less than 0.8 sec. To reach standard Wow and Flutter
Capstan Motor:	FG (frequency generator) DC servo motor
Reel Motors:	Slotless DC motors x 2
Head Configurations:	3 heads; erase, record/sync and reproduce
Tape Cue:	Manual
Dimensions:	(W) 16-3/16" x (H) 18-3/16" x (D) 10-1/8" (410 x 461 x 256 mm)
Weight:	49 lbs (22 kg), net

ELECTRICAL

Line Input:	
Input impedance:	50k ohms, unbalanced
Maximum source impedance:	2.5k ohms
Nominal input level:	-10 dBV (0.3 V)
Maximum input level:	+18 dBV (8.0 V)
Nominal input source impedance	1k ohms
Mic Input:	
Source impedance:	10k ohms or less
Input impedance:	10k ohms, unbalanced
Nominal input level:	-60 dBV (1 mV)
Maximum input level:	-3 dBV (700 mV), with mic ATT (20 dB) engaged.
Line Output:	
Output impedance:	1k ohms, unbalanced
Minimum load impedance:	10k ohms
Nominal load impedance:	50k ohms
Nominal output level:	-10 dBV (0.3 V)
Maximum output level:	+18 dBV (8.0 V)
Headphone output:	100 mW maximum at 8 ohms stereo headphones
Bias Frequency:	150 kHz
Equalization:	NAB standard
Record Level Calibration:	3180 + 50 μ sec at 15 ips (38 cm/sec), 7-1/2 ips (19-cm/sec)
Frequency Response:	0 VU reference; 250 nWb/m tape flux level
Overall:³⁾	
15 ips	40 Hz – 22 kHz, ± 3 dB at 0 VU 40 Hz – 22 kHz, ± 3 dB at -10 VU
7-1/2 ips	40 Hz – 16 kHz, ± 3 dB at 0 VU 40 Hz – 20 kHz, ± 3 dB at -10 VU
Playback (both Sync and Reproduce heads):²⁾	
15 ips	40 Hz – 22 kHz, ± 3 dB
7-1/2 ips	40 Hz – 20 kHz, ± 3 dB
Total Harmonic Distortion (THD):³⁾	0.8 % at 0 VU, 1,000 Hz, 250 nWb/m 3 % at 13 dB above 0 VU, 1,000 Hz, 1,116 nWb/m
Signal-to-Noise Ratio:³⁾	At a reference of 1 kHz, at 13 dB above 0 VU, 1,116 nWb/m
15 ips	68 dB A weighted (NAB), 60 dB unweighted
7-1/2 ips	66 dB A weighted (NAB), 58 dB unweighted 92 dB A weighted (NAB), with dbx * 82 dB unweighted, with dbx

Adjacent Channel Crosstalk (Overall):³⁾

Erasure:³⁾

Headroom:

Connectors:

Line inputs and outputs:

Remote control:

Punch in/out remote:

dbx unit:

Power Requirement:

Better than 50 dB down at 1,000 Hz, 0 VU

Better than 65 dB at 1 kHz, +10 VU reference

Recording Amplifier – Better than 25 dB above 0VU at 1 kHz

RCA jack

Multi-Pin jack

Phone jack (Tip-Sleeve)

Multi-Pin jack

100/120/220/240 V AC, 50/60 Hz, 73 W (General Export Model)

120 V AC, 60 Hz, 73 W (USA/Canada Model)

220 V AC, 50 Hz, 73 W (Europe Model)

240 V AC, 50 Hz, 73 W (UK/AUS Model)

In these specifications, 0 dBV is referenced to 1.0 Volt. Actual voltage levels also are given in parenthesis. To calculate the 0 dB = 0.775 Volt reference level (i.e., 0 dBm in a 600-ohm circuit) add 2.2 dB to the listed dB value; i.e., -10 dB re: 1 V = -7.8 dB re: 0.775 V.

1) Specifications were determined using TEAC Test Tape YTT-2004/YTT-2003.

2) Specifications were determined using TEAC Test Tape YTT-1004/YTT-1003.

3) Specifications were determined using AMPEX #456 Tape.

Changes in specifications and features may be made without notice obligation.

*dbx is a trademarks of dbx Inc.

Options for:

Mounting (EIA Standard 19-inch rack): CS-607B Console Rack, RM-300 Rack Mount Angle and

T-0804 Blank Panel (normally 2 panels used)

Remote control: Full transport function available with RC-71

Punch in/out remote control: Punch in/out function available with RC-30P

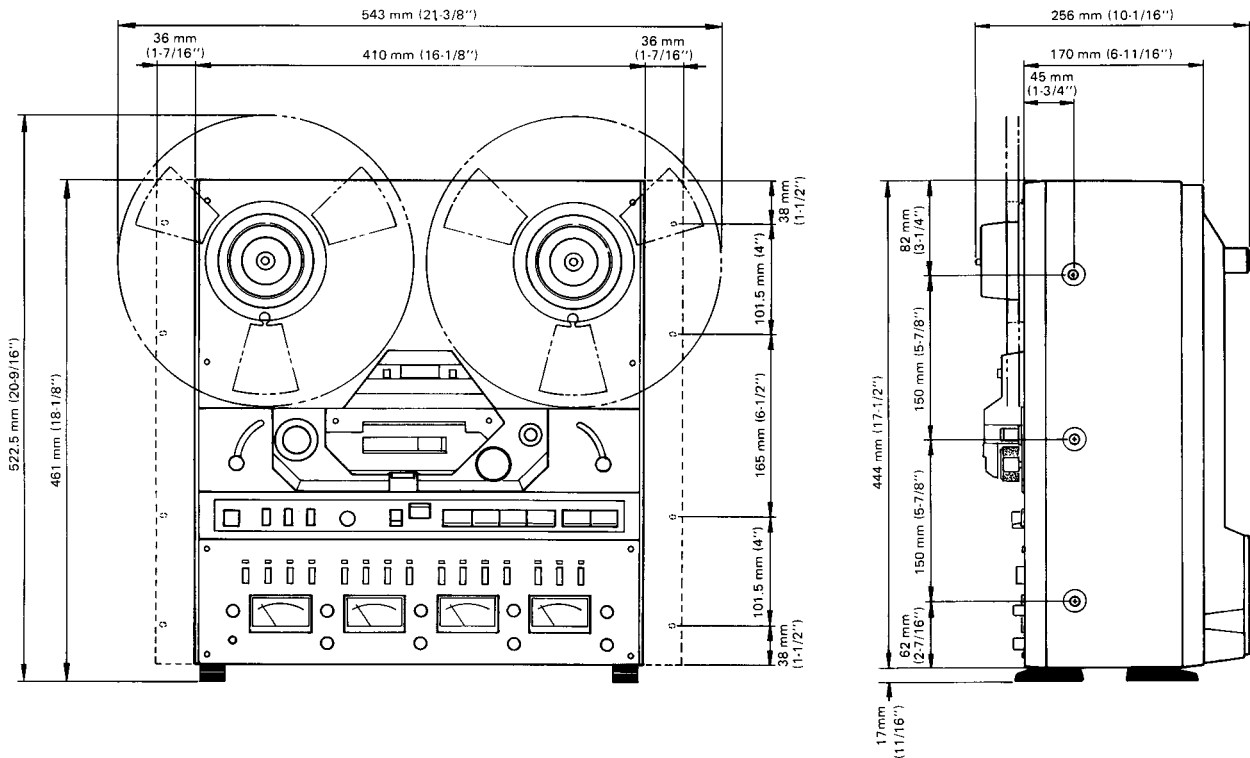

THEORY OF OPERATION—MAINTENANCE

If you are new to high quality sound recording equipment, you should become aware of the fact that high quality sound requires high quality maintenance.

Recording studios that rent time by the hour are very fussy about maintaining their equipment. Tape recorders and other electronic gear in the studio are checked out before every session. And, if necessary, adjusted to "spec" by an "in house" service technician. He is usually prepared to correct any problem from a minor shift in circuit performance to major breakdown in a motor. He has a full stock of spare parts and all the test equipment he needs.

Now that you are running your own "studio" you will have to make some decisions about maintaining it, and your 34B. You will have to become your own "in house" service technician. Well, what about the test gear and the spare parts? A stock of spare parts and a super deluxe electronic test bench can easily cost many times the price of the recorder. Fortunately, the most frequently needed adjustments use the least expensive equipment, and the very costly devices are only needed for major parts replacements such as drive and rewind motors or head assemblies. Replacing parts cannot be considered "daily maintenance" by any means, so we suggest that you leave the major mechanical and electrical repair to the Dealer Service Center. That's what it's for.

Adjustments to the motors — back tension and brake torque are not required often and can safely be left to dealer service. The adjustments for wow and flutter require several thousands of dollars of test gear to perform. It's not practical to consider doing these adjustments yourself unless you have fifty machines to service. Then it might pay to buy the test gear.

In order to help you make plans about the more routine adjustments to your 34B, we have made this section of the manual as easy to understand as technology will allow. It's a short course in tape recorder theory as well as a list of adjustments and will help you to understand that is going on inside when you record. Read the manual, decide what test equipment you can afford (although it is not violently expensive, it is not free) and determine what service you can do yourself.

TEST EQUIPMENT/MATERIALS

To make electronic adjustments, you need test gear, so let's go over what's necessary.

1) Alignment Tapes

You need one for each speed that the recorder operates at. For the 34B the specs are:

Reference fluxivity: 250 nWb/m
Equalization standard: NAB
15 ips (38 cm/sec) 3180 μ s + 50 μ s
7-1/2 ips (19 cm/sec)
3180 μ s + 50 μ s

These test tapes are made by several companies, but there are many different tape specs. Be sure you have the right one.

Lets's talk about each spec separately.

STL3 or MRL21J205 = Tape speed 15 ips

STL22 or MRL21T204 = Tape speed 7.5 ips

Reference fluxivity: 250 nWb/m

Equalization: NAB; time constant 3180 + 50 μ sec.

— or —

TEAC YTT-1004 = Tape speed 15 ips

TEAC YTT-1003 = Tape speed 7.5 ips

All specs are identical with STL or MRL tapes except for the reference fluxivity which is 185 nWb/m, and thus, its reproduce output level will be 3 dB lower compared with 250 nWb/m fluxivity. Calibration level under "Reproduce Calibration" refers 0 VU as 250 nWb/m.

Reference Fluxivity — How much magnetic energy is necessary on the tape to make the meter read "0 VU" in playback? This is the "benchmark" or standard you tune your playback electronics to. 250 nano Webers per meter is the correct value for the 34B. If a lower or higher "Reference Fluxivity" is used to set up the playback, all your other measurements will be off.

NAB Equalization – Here we have a lot to talk about. The process of magnetic recording is far from “flat.” Every circuit in a tape recorder will alter the level of signal with respect to its frequency – some deliberately, some unavoidably. The deliberate errors are used to overcome the unavoidable problems. Here is a selection of frequency response graphs at various points in the recording process:

1. The input signal starts this way in the beginning (FLAT).

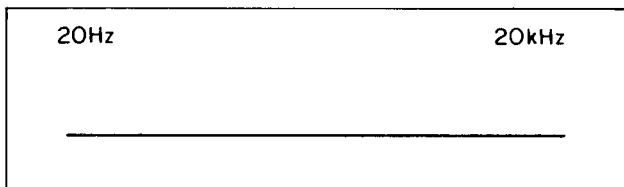

Fig. 5

2. EQ to overcome head loss at high frequency and bass anomalies (NAB)
Deliberate error

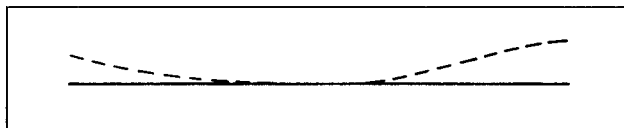

Fig. 6

3. Record Head Response
(6 dB per octave rise until gap in head approaches wavelength)
Unavoidable error
Small wavelengths (high frequencies) are partially erased as fast as they are recorded.

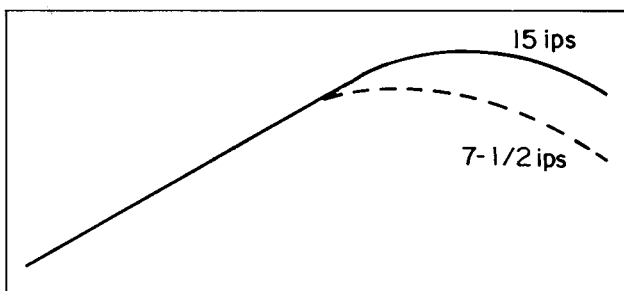

Fig. 7

We will assume something is recorded, but it's not flat on the tape either. Now we'll play it back.

4. Playback Head Response
(6 dB per octave rise again, same as record head).
Unavoidable error,
Small wavelengths are not picked up by gap.

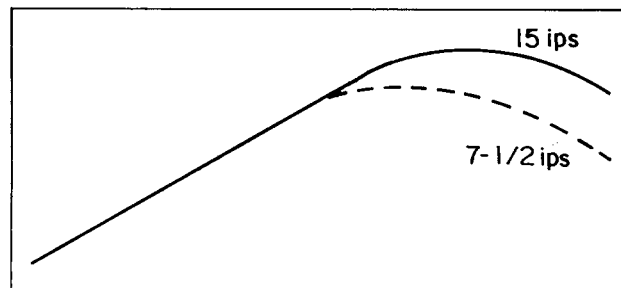

Fig. 8

5. Playback EQ
Now we must overcome the characteristic response of heads.
Big deliberate error
Helps lower tape hiss as well as restoring proper levels to high frequencies.

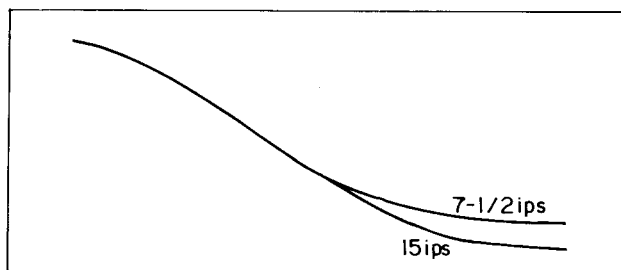

Fig. 9

6. The result of all this equalization is this (hopefully).

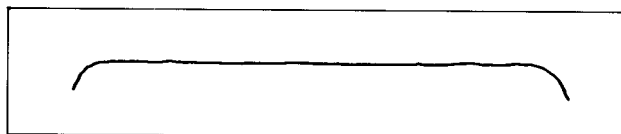

Fig. 10

The idea is to use the electronics that are adjustable to cope with the problems that are caused by the nature of the magnetic recording process. We can't change the basic laws of magnetic physics, so we change the record and playback equalization. Now comes the sticky part. How much EQ do we use in each stage? If every manufacturer of tape recorders used their own standard, their idea of what was best, there would be no playback compatibility. Tapes made on one recorder would not playback properly on another of different make. The standards for

record and playback equalization are established by societies of scientists, engineers and users in the profession. They are:

- NAB** National Association of Broadcasters
- IEC** International Electrotechnical Commission
- CCIR** International Radio Consultive Commission
- DIN** Deutsche Industrie Normen

Unfortunately, they don't all agree. Each organization has a slightly different approach to solving the problems of tape recording. Scientists and engineers are human, as well, and have been known to disagree, sometimes violently about what ways are best. Advances in the manufacture of tape, improvements in head design, and the lowering of electronic circuit costs have made bizarre solutions quickly change into practical realities. The optimums have shifted and will probably continue to do so. Standards are set by man, not cast in stone.

But while the scientists are boxing in the conference room, we would like to be recording, so TASCAM has selected the NAB for record/reproduce equalization as the recommendation for the 34B.

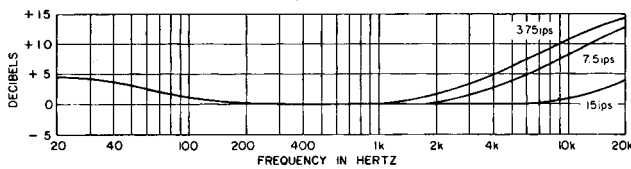

Typical recording (pre-equalization) for 1/4-inch tape recorders using NAB characteristics.

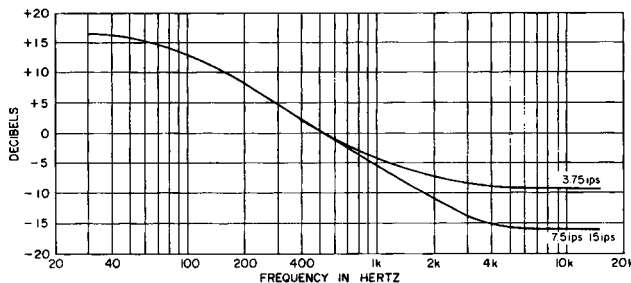

Typical post-equalization for 1/4-inch tape recorders using NAB characteristics.

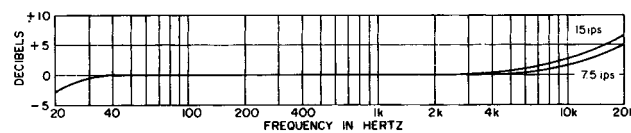

Typical pre-equalization characteristics for 1/4-inch tape recorders running at 7.5 and 15 ips using the CCIR (DIN) standard.

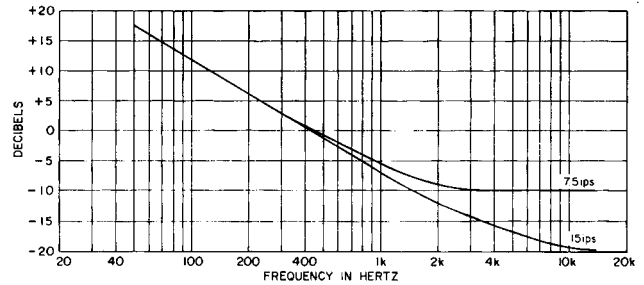

Typical post-equalization curves for 1/4-inch recorders using CCIR characteristics, at 7.5 and 15 ips.

You will need a separate reference tape for each speed. The curves are not the same.

Since these Reference Standard tapes cost about 3 times the price of a big roll of the best blank tape, plan on storing them carefully in a place that will not encounter any magnetic fields that might damage them – away from loudspeakers, guitar pickup, tape recorder and record player motors, power amplifiers (magnetic field surges in big transformers when amps are turned on and off can be very powerful) or anything magnetic that might alter the quality of the reference standard. If you don't damage them physically or magnetically (don't play them on dirty or magnetized recorders, or loan them out to the careless) they will last for several years.

If it is not possible to obtain a tape that has both the NAB EQ and a fluxivity of 250 nWb/m, select the NAB EQ as the preferred single standard. A different reference fluxivity requires only that you make a level correction once. Just use a different mark on the meter instead of "zero." A different EQ curve requires a different amount of correction for each frequency and is much harder to use – especially for a beginner. Level corrections for different reference fluxivity:

		Use this instead of "0" VU
15 ips	185 nWb/m – (Ampex operating level)	-3 VU
	200 nWb/m – (STL, MRL)	-2 VU
7-1/2 ips	185 nWb/m operating sweep frequencies	-3 VU
	200 nWb/m operating sweep frequencies	-13 VU
		-2 VU
		-12 VU

Below are tabulated some commonly encountered flux levels along with their dB differences, and their differences in dB from 185 nWb/m.

	Flux Level nWb/m	Flux Level Difference in dB	Difference from 185 nWb/m in dB
	150		1.82
	160	0.56	1.26
	170	0.53	0.73
	180	0.50	0.24
Ampex operating level	185	0.24	0.00
	190	0.23	0.23
	200	0.45	0.68
	210	0.42	1.10
	220	0.40	1.51
	230	0.39	1.89
	240	0.37	2.26
	250	0.35	2.62
3 dB above Ampex operating level	260	0.34	2.96
	261.32	0.04	3.00
	270	0.28	3.28
	280	0.32	3.60
	290	0.30	3.90
	300	0.29	4.20
	310	0.28	4.48
DIN Standard	320	0.28	4.76
	330	0.27	5.03
	340	0.26	5.29
	350	0.25	5.54
	360	0.24	5.78
6 dB above Ampex operating level	369.12	0.22	6.00
	370	0.02	6.02
	380	0.23	6.25
	390	0.23	6.48
	400	0.22	6.70

Note:
Add 0.7 dB for European Measurement Method using Magnetometer.

IEC Correction Chart (illus.)

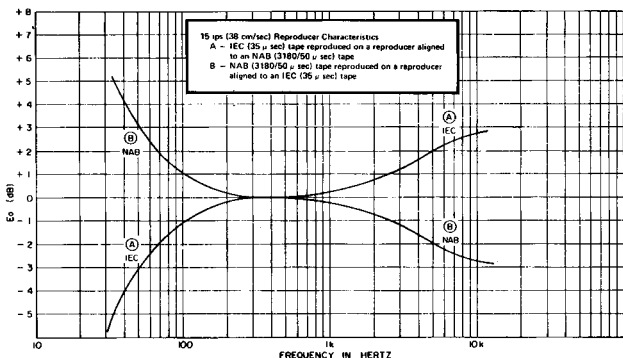

If you must use IEC EQ tapes, these readings are correct. IEC has less boost in playback, the tape will read progressively higher as frequencies rise when played on a NAB adjusted recorder. At 250 nWb/m reference read these numbers to set IEC EQ.

30 50 100 400 1K 3K 5K 7K 10K 15K
 -5.4 -3.0 -0.6 0 +0.2 +1.2 +2.3 +2.6 +2.7 +2.9 +3.0 +3.0 dB

See "Test Tapes for the 34B" on page 28.

Since the low frequency EQ on the 34B is fixed, the differences are academic. On to the next piece of test equipment.

2) VTVM or FET Multimeter

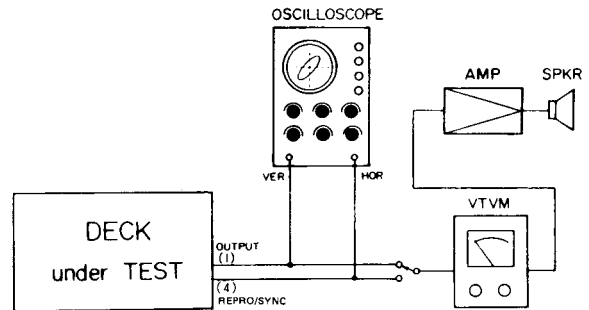

Head Alignment Fine Adjustment Set-up and Test Connections (REPRODUCE)

Use a VTVM or FET multimeter with an input impedance of at least 1 megohm that can read levels down to -70 (full scale) you can think of this as a very accurate VU meter of very wide range. Meters with lower input impedances will draw power from the circuits to be measured and will affect the readings. Meters that have adequate input impedance but do not read below -40 (0.01 V) can be used for reference levels and frequency response measurements, but will not be capable of making signal-to-noise, erase efficiency or bias circuit measurements where the output of the circuit being adjusted is expected to be very low. Meter MUST have wide, flat frequency response (minimum = 10 Hz - 1 MHz).

This tool is not cheap and is just as important as the test tapes. Without a good reference meter, you can do very little in the way of accurate adjustment. Spend as much as you can here. It's worth it. Next. . .

3) Signal Generator or Oscillator

Here you get a break. A simple oscillator will do all the work and won't send you to the poor house. There are several on the market for

around \$100. The local electronic surplus store can be a good source for test equipment that can be re-calibrated by the manufacturer for a reasonable cost. If you get one with a meter on it, you won't have to calibrate its output with the big meter as often. This device is very useful in a studio for troubleshooting a good investment. It should have at least the following frequencies.

40 Hz — 100 Hz — 400 Hz — 1 kHz — 4 kHz
— 10 kHz — 15 kHz — 18 kHz

Sine wave is all that is required, at a distortion of no more than 0.5%. Most modern units do better than this easily. This unit is the workhorse on the equipment list. Whether you are reading the big meter (FET) or the meters on the recorder, you will need a signal to read, this instrument or the test tapes will provide you with signals.

Test tapes, tone generator, VTVM or FET meter . . . This is the basic package and will do almost every adjustment in the sequence — except the first one . . .

4) The Oscilloscope

Even a simple one is not cheap. Fortunately, a simple one is all you need. You can spend \$6,000 and more for the big ones, but for this purpose \$100 — \$200 will be more than enough. It must have a "vertical" and a "horizontal" amplifier and an X-Y mode. That's all you use to do the one adjustment you need it for. Assuming that the motors are not in need of attention (that's for Dealer Service), Azimuth, or head alignment is the number one step in maintenance . . . so let's begin.

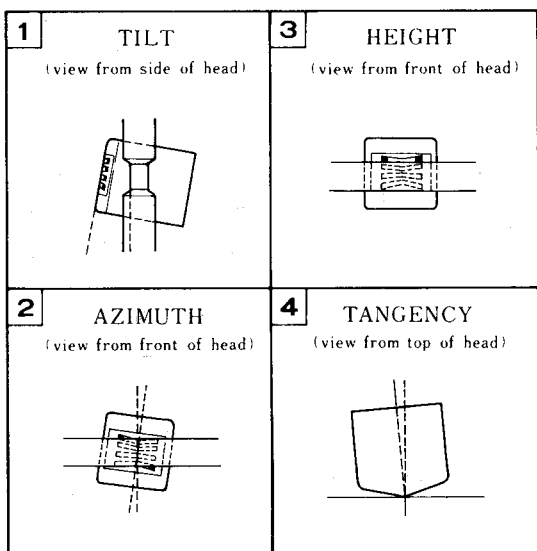

Head Mis-Alignment Example

T-619

The gaps in the heads that do the erasing, recording, and playing back must be precisely perpendicular to the tape. PRECISELY. Even a tiny error in alignment will make problems for the recorder. If the heads are not in alignment, both with the tape, and with respect to each other, tones recorded on one head will not play properly on the other. In the table below, the error is shown with the loss in dB. The amount of tilt is given in the fractions of a degree called minutes, 60 minutes to a degree. As you can see, it only takes 1/4 degree to cause big trouble.

1-Mil Wavelength		½-Mil Wavelength		¼-Mil Wavelength	
Loss in dB	Azimuth Error in Minutes	Loss in dB	Azimuth Error in Minutes	Loss in dB	Azimuth Error in Minutes
0.5 dB	14.86	0.5 dB	7.43	0.5 dB	3.71
1.0 dB	20.90	1.0 dB	10.45	1.0 dB	5.22
2.0 dB	29.21	2.0 dB	14.60	2.0 dB	7.30
3.0 dB		3.0 dB	17.67	3.0 dB	8.83
4.0 dB		4.0 dB	20.16	4.0 dB	10.08
5.0 dB		5.0 dB	22.16	5.0 dB	11.13
6.0 dB		6.0 dB	24.08	6.0 dB	12.04
7.0 dB		7.0 dB	25.68	7.0 dB	12.84
8.0 dB		8.0 dB	27.09	8.0 dB	13.54
9.0 dB		9.0 dB	28.36	9.0 dB	14.18
10.0 dB		10.0 dB	29.50	10.0 dB	14.75

Loss due to azimuth misalignment for 43-mil quartertrack. (Courtesy, Ampex Corp. Test Tape Laboratory)

Since the 34B can use a single head (head #2 in the stack) to perform all functions (recording, sync play and playback) it won't hurt the recorder to use the "whizbang studio alignment" procedure, which is to do nothing about alignment at all. You won't notice anything wrong with the sound you make, but there are drawbacks.

1. Your tapes won't play properly on any other recorder (whizbang standards are unique).
2. No accurate tune-up of the recorder will be possible, as most test procedures use one head as a reference for the other. To do this, they must be aligned perfectly.

Thread the 7-1/2 ips test tape on the recorder and find the operating level section of the tape. Connect the outputs for tracks 1 and 4 of the recorder to the 2 inputs of an oscilloscope, track 1 to the vertical input that makes the beam draw lines up and down and 4 to the horizontal input (draws lines left to right). Set the scope to the "Vector" or XY mode. You will have to consult the instruction book

for the scope to determine how to do this. We don't know what brand of test gear you have. Play the tone, and this is what you should see:

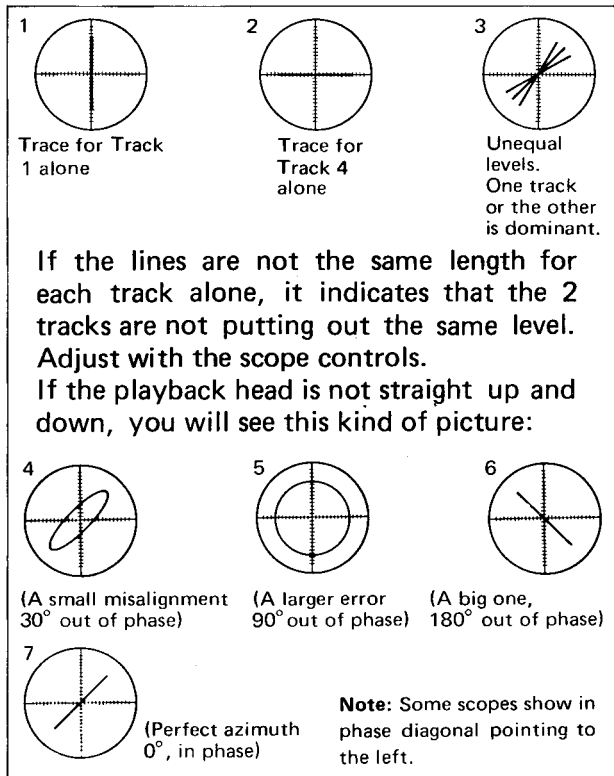

Phase Shift

How much distance error is involved depends on the frequency or pitch of the tone and the speed of the tape. One "cycle" per second at 15 ips would be hard to misalign. To get scope picture No. 6, you would have to separate the gaps in the playback head by 7-1/2 inches, but one cycle per second is not audio. How about 1,000 cycles per second of tape travel? At 15 ips, the separation or tilt in the head for scope picture No. 6 becomes 0.0075 inch. And at 15,000 Hz at 15 ips it's 0.0005 inch. Not much tilt will produce a big error. Slower tape speeds mean even smaller spacings and good azimuth becomes even more important. The proper method of adjustment is to look first at a long wave, say 1000 cycles, and make a coarse adjustment. Then work up in frequency, adjusting shorter and shorter wavelengths smaller and smaller amounts. If you start adjusting with 10 kHz or 15 kHz, you can make a big mistake. Here's why. . . . Since the very short wavelengths are very close together on the tape, it is possible to get a good "picture" on the scope by adjusting

one full cycle off. If you work up to 15K, checking and adjusting as you go, you will avoid this mistake.

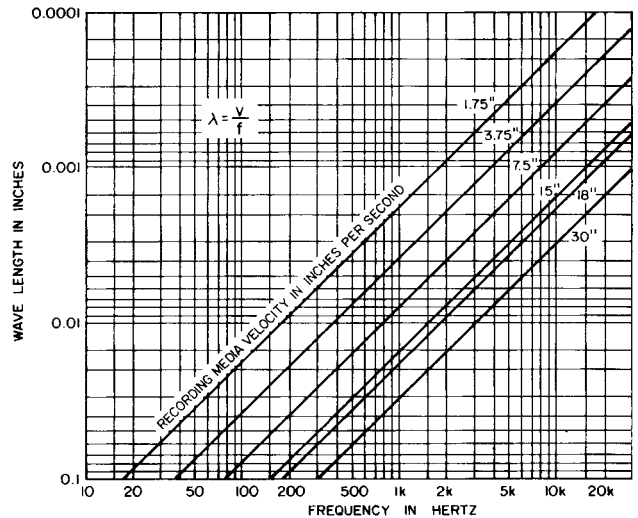

Velocity of recording media versus recorded wavelength in inches for a given frequency.

Once you have everything set up – the reference tape is playing, the scope is running and showing the x-y display, you need a Phillips head screwdriver and this diagram to find the right adjustment point. Adjusting the screw will rotate the head very slightly.

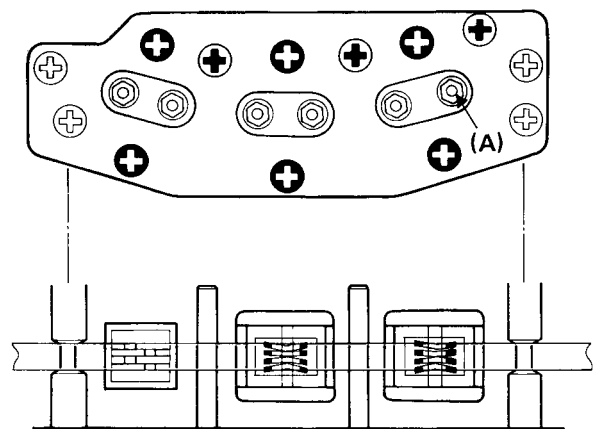

- ① ERASE HEAD
- ② RECORD SYNC HEAD
- ③ REPRO HEAD

- ⊕ AZIMUTH ADJ. SCREWS
- ⊙ HEIGHT AND TILT ADJ. SCREWS
- ⊙ TANGENCY ADJ. NUTS(A)

Head Adjustment Screws and Alignment

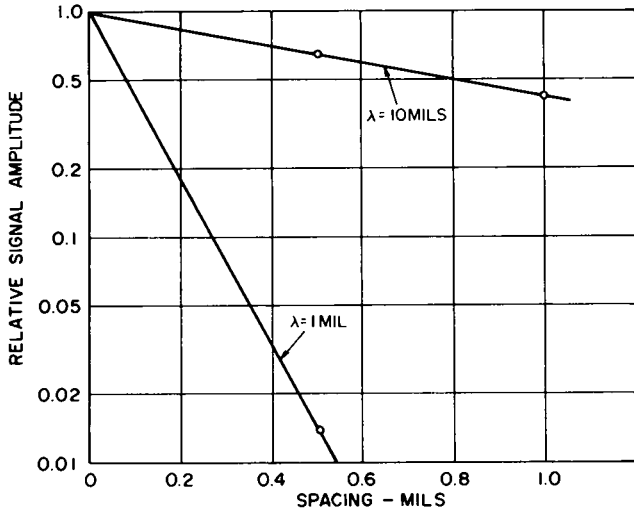

Curves showing fall-off of reproduced signals versus spacing from reproducer head.
(Courtesy, Minnesota Mining and Manufacturing Co.)

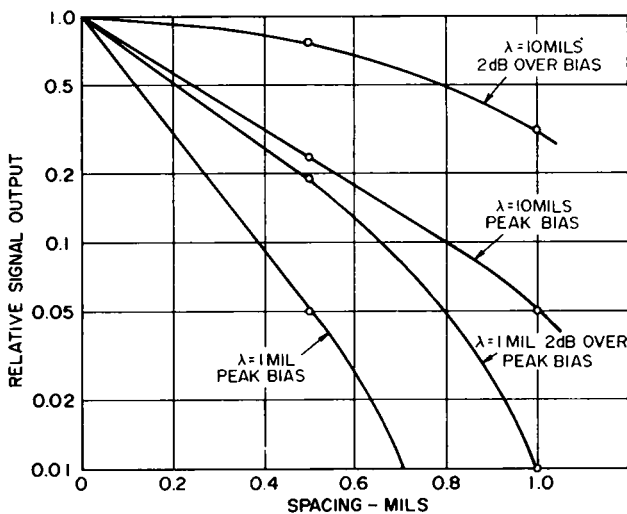

Curves showing the fall-off of recorded signals versus spacing from recording head.
(Courtesy, Minnesota Mining and Manufacturing Co.)

Head Location and Adjustment

Head block illustration showing all parts, tape path, and all adjustment screws for guides and head adjustments. Larger screws are for azimuth adjustment.

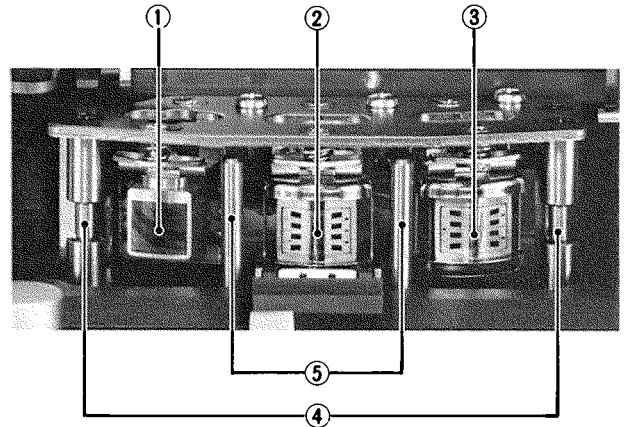

Head Location and Adjustment

- ① ERASE HEAD
- ② RECORD/SYNC HEAD
- ③ REPRODUCE HEAD
- ④ TAPE GUIDES
- ⑤ TAPE LIFTERS

The next step is to play all the signals from the lowest frequency to the highest on the 7-1/2 ips alignment tape — one play for each head position (2–3), and DO NOTHING. Just have a look. It's not a good idea to turn knobs just to "see what happens." Just because an adjustment can be made doesn't mean it's necessary. The recorder is very solid and is well adjusted at the factory, so in all test and maintenance procedures, check first, then if something is not right, adjust. Taking your time will save endless grief. A new machine is very likely to be "on the money" when you get it and if you keep it clean and degaussed will drift away from top shape very slowly. It's not necessary to plan on a major overhaul when it comes out of the box.

DAILY SETUP

It's obvious that this entire procedure is not something that can be completed quickly. You don't begin a "major" ten minutes before the musicians arrive. It is not likely to be necessary every day, but what is reasonable? Most good engineers make several quick tests. If nothing is amiss, they start setting up the rest of the session with confidence. If there is a problem, they go further. Here is what they do.

1. Clean and degauss. Obvious first step.
2. After the recorder has been on for 10 minutes and is nicely warmed up, they check the reproduce response with the test tape. A little trim? OK, no problem.
3. They then set up the signal generator and record several frequencies, say 100 Hz, 4k, 10k. Looks good? Then we can begin.
4. A very fussy engineer will take a look at the bias adjust to make sure everything is OK there as well, before he looks at the record EQ.

These several quick checks will usually uncover any serious troubles, and the idea is to work backwards up the chain of adjustments if anything shows an error. "Reproduce" is the first step in a major overhaul, and Record EQ is the last. If everything works OK, you can assume all is well. If you get something funny as a reading, you will have to track it down, but these tests will usually give you some idea of where the problem lies. Work backwards through the recorder (that's forward through the adjustments, by the way, they run from back to front in the procedure, don't get confused) until you uncover the problem. You always clean and degauss, and you should always check the reproduce response with the test tape. Again, reproduce, bias, record check, no problems, OK, go, and good luck with your tapes.

Speaking of tape, the 34B has been designed to use 1.5 mil tape, the use of 1 mil tape is not recommended, we strongly suggest that you buy good quality tape and stick to one kind. White box tape is cheap for a reason. It doesn't perform as well as the "good stuff", and will be hard to tune up to, and may even damage your recorder. Excessive shedding of oxide, uneven slitting and other defects too numerous to mention will make all your efforts go for very little. Tape is important, use the best.

GENERAL ADVICE ON MAINTENANCE

Don't attempt to adjust a stone cold machine. Turn it on and let it warm up for 30 minutes.

Don't adjust the "traps" with a metal screw driver or tool. The metal tip will affect the value of the part and will give false readings. Use a plastic T.V. adjustment tool, or cut a strip of rigid plastic to size. (Credit cards will work, if you have an old one you don't need.)

Suspect any large change in adjustment that happens all at once.

Stop and think, if you turn a pot and get no change in reading, have you adjusted the wrong control?

Remove the alignment tape from the heads when switching power "on" or "off." A switching transient on a badly adjusted recorder can "print" on the tape.

Tape and electronic "hiss" should be smooth sounding. If, when recording, you detect popping, or sputtering noises, degauss the heads. If this doesn't change the sound, plan on a record bias trap adjustment.

If the oscilloscope picture is not stable when using the alignment tape (the trace opens and shuts like a mouth) suspect the holdback torque adjustment. When recording and playing test tones, suspect the tape slitting as well as the motor adjusts. If the reference tape doesn't do this, but the recording tape does, it's definitely not the recorder. It is the tape that is at fault.

At the end of a session, take the time to slow wind (play) the roll off the machine and store it "tails out." This is the best way.

Don't plan on recording over a splice. Any steady tone such as singing, or violins that you attempt to print over a cut in the tape may show a dropout, or momentary interruption. Even the best splice in the world is thicker than normal. The splicing tape adds quite a lot, and makes the tape "bump" when it goes by the head. This is especially important if you are using DBX. The dropout will be made much more noticeable by the action of the DBX.

It is a good idea to pad your master tapes by winding some blank tape on both ends, and adding leader tape.

Put a test tone (1 kHz) on each tape for reference level checks. Then it's easier to set up machines and mixers when recording sessions occur on different dates or different machines.

Keep a TRACK SHEET. Write down what happened during the session and what went on to the tape. You might list such things as mic placement; complete/incomplete takes; brand of tape used; speeds; noise reduction; comments (for example: a producer might have liked a particular bass part more than others, so you can save it and use it during overdubbing and mix-down).

Have the tools of the trade handy – leader tape, razor blades, splicing tape, masking tape, grease pencils, etc.

There's another old saying around studio circles: If it's not labeled, use it. So it's a very good idea to label all tape boxes and reels. And pack a track sheet in every box.

When you're not working on a tape, it's safest to put it in its box; don't leave it on the machine where an accident could wipe out weeks of work.

TASCAM

TEAC Professional Division

34B

TEAC CORPORATION	3-7-3, Nakacho, Musashino-shi, Tokyo 180, Japan Phone: (0422) 52-5081
TEAC AMERICA, INC.	7733 Telegraph Road, Montebello, California 90640 Phone: (213) 726-0303
TEAC CANADA LTD.	340 Brunel Road, Mississauga, Ontario L4Z 2C2, Canada Phone: 905-890-8008
TEAC UK LIMITED	5 Marlin House, Marlin Meadow, The Croxley Centre, Watford, Herts. WD1 8YA, U.K. Phone: 0923-819631
TEAC DEUTSCHLAND GmbH	Bahnstrasse 12, 65205 Wiesbaden-Erbenheim, Germany Phone: 0611-71580
TEAC FRANCE S.A.	17, Rue Alexis-de-Tocqueville, CE 005 92182 Antony Cedex, France Phone: (1) 42.37.01.02
TEAC NEDERLAND BV	Perkinsbaan 11, 3439 ND Nieuwegein, Nederland Phone: 03-402-30229
TEAC AUSTRALIA PTY., LTD. A.C.N. 005 408 462	106 Bay Street, Port Melbourne, Victoria 3207, Australia Phone: (03) 646-1733
TEAC ITALIANA S.p.A.	Via C. Cantù 5, 20092 Cinisello Balsamo, Milano, Italy Phone: 02-66010500