

TASCAM

TEAC Professional Division

102MKII

Master Cassette Deck

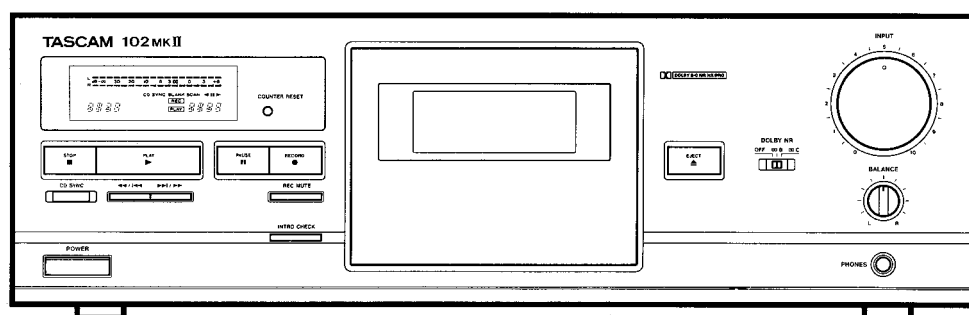

OWNER'S MANUAL



CAUTION

RISK OF ELECTRIC SHOCK
DO NOT OPEN



CAUTION: TO REDUCE THE RISK OF ELECTRIC SHOCK, DO NOT REMOVE COVER (OR BACK). NO USER-SERVICEABLE PARTS INSIDE. REFER SERVICING TO QUALIFIED SERVICE PERSONNEL.



The lightning flash with arrowhead symbol, within an equilateral triangle, is intended to alert the user to the presence of uninsulated "dangerous voltage" within the product's enclosure that may be of sufficient magnitude to constitute a risk of electric shock to persons.



The exclamation point within an equilateral triangle is intended to alert the user to the presence of important operating and maintenance (servicing) instructions in the literature accompanying the appliance.

This appliance has a serial number located on the rear panel. Please record the model number and serial number and retain them for your records.
Model number _____
Serial number _____

WARNING: TO PREVENT FIRE OR SHOCK HAZARD, DO NOT EXPOSE THIS APPLIANCE TO RAIN OR MOISTURE.

Important Safety Instructions

CAUTION:

- Read all of these Instructions.
- Save these Instructions for later use.
- Follow all Warnings and Instructions marked on the audio equipment.

- 1) **Read Instructions** — All the safety and operating instructions should be read before the product is operated.
- 2) **Retain instructions** — The safety and operating instructions should be retained for future reference.
- 3) **Heed Warnings** — All warnings on the product and in the operating instructions should be adhered to.
- 4) **Follow instructions** — All operating and use instructions should be followed.
- 5) **Cleaning** — Unplug this product from the wall outlet before cleaning. Do not use liquid cleaners or aerosol cleaners. Use a damp cloth for cleaning.
- 6) **Attachments** — Do not use attachments not recommended by the product manufacturer as they may cause hazards.
- 7) **Water and Moisture** — Do not use this product near water — for example, near a bath tub, wash bowl, kitchen sink, or laundry tub; in a wet basement; or near a swimming pool; and the like.
- 8) **Accessories** — Do not place this product on an unstable cart, stand, tripod, bracket, or table. The product may fall, causing serious injury to a child or adult, and serious damage to the product. Use only with a cart, stand, tripod, bracket, or table recommended by the manufacturer, or sold with the product. Any mounting of the product should follow the manufacturer's instructions, and should use a mounting accessory recommended by the manufacturer.
- 9) A product and cart combination should be moved with care. Quick stops, excessive force, and uneven surfaces may cause the product and cart combination to overturn.



- 10) **Ventilation** — Slots and openings in the cabinet are provided for ventilation and to ensure reliable operation of the product and to protect it from overheating, and these openings must not be blocked or covered. The openings should never be blocked by placing the product on a bed, sofa, rug, or other similar surface. This product should not be placed in a built-in installation such as a bookcase or rack unless proper ventilation is provided or the manufacturer's instructions have been adhered to.
- 11) **Power Sources** — This product should be operated only from the type of power source indicated on the marking label. If you are not sure of the type of power supply to your home, consult your product dealer or local power company. For products intended to operate from battery power, or other sources, refer to the operating instructions.
- 12) **Grounding or Polarization** — This product may be equipped with a polarized alternating-current line plug (a plug having one blade wider than the other). This plug will fit into the power outlet only one way. This is a safety feature. If you are unable to insert the plug fully into the outlet, try reversing the plug. If the plug should still fail to fit, contact your electrician to replace your obsolete outlet. Do not defeat the safety purpose of the polarized plug.
- 13) **Power-Cord Protection** — Power-supply cords should be routed so that they are not likely to be walked on or pinched by items placed upon or against them, paying particular attention to cords at plugs, convenience receptacles, and the point where they exit from the product.
- 14) **Outdoor Antenna Grounding** — If an outside antenna or cable system is connected to the product, be sure the antenna or cable system is grounded so as to provide some protection against voltage surges and built-up static charges. Article 810 of the National Electrical Code, ANSI/NFPA 70, provides information with regard to proper grounding of the mast and supporting structure, grounding of the lead-in wire to an antenna discharge unit, size of grounding conductors, location of antenna-discharge unit, connection to grounding electrodes, and requirements for the grounding electrode.

"Note to CATV system installer:

This reminder is provided to call the CATV system installer's attention to Section 820-40 of the NEC which provides guidelines for proper grounding and, in particular, specifies that the cable ground shall be connected to the grounding system of the building, as close to the point of cable entry as practical.

Example of Antenna Grounding as per National Electrical Code, ANSI/NFPA 70

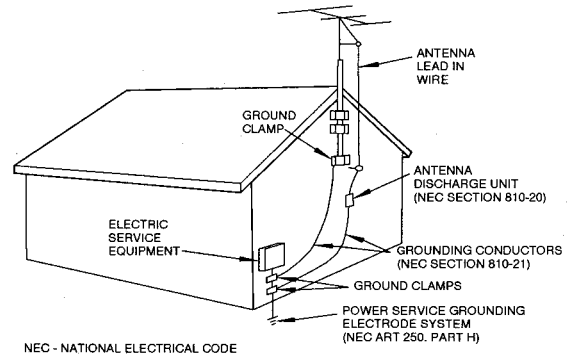

- 15) **Lightning** — For added protection for this product during a lightning storm, or when it is left unattended and unused for long periods of time, unplug it from the wall outlet and disconnect the antenna or cable system. This will prevent damage to the product due to lightning and power-line surges.
- 16) **Power Lines** — An outside antenna system should not be located in the vicinity of overhead power lines or other electric light or power circuits, or where it can fall into such power lines or circuits. When installing an outside antenna system, extreme care should be taken to keep from touching such power lines or circuits as contact with them might be fatal.
- 17) **Overloading** — Do not overload wall outlets, extension cords, or integral convenience receptacles as this can result in risk of fire or electric shock.
- 18) **Object and Liquid Entry** — Never push objects of any kind into this product through openings as they may touch dangerous voltage points or short-out parts that could result in a fire or electric shock. Never spill liquid of any kind on the product.
- 19) **Servicing** — Do not attempt to service this product yourself as opening or removing covers may expose you to dangerous voltage or other hazards. Refer all servicing to qualified service personnel.
- 20) **Damage Requiring Service** — Unplug this product from the wall outlet and refer servicing to qualified service personnel under the following conditions:
 - a) when the power-supply cord or plug is damaged.
 - b) if liquid has been spilled, or objects have fallen into the product.
 - c) if the product has been exposed to rain or water.
 - d) if the product does not operate normally by following the operating instructions. Adjust only those controls that are covered by the operating instructions as an improper adjustment of other controls may result in damage and will often require extensive work by a qualified technician to restore the product to its normal operation.
 - e) if the product has been dropped or damaged in any way.
 - f) when the product exhibits a distinct change in performance — this indicates a need for service.
- 21) **Replacement Parts** — When replacement parts are required, be sure the service technician has used replacement parts specified by the manufacturer or have the same characteristics as the original part. Unauthorized substitutions may result in fire, electric shock, or other hazards.
- 22) **Safety Check** — Upon completion of any service or repairs to this product, ask the service technician to perform safety checks to determine that the product is in proper operating condition.
- 23) **Wall or Ceiling Mounting** — The product should be mounted to a wall or ceiling only as recommended by the manufacturer.
- 24) **Heat** — The product should be situated away from heat sources such as radiators, heat registers, stoves, or other products (including amplifiers) that produce heat.

REFERENCE ILLUSTRATIONS

Front Panel

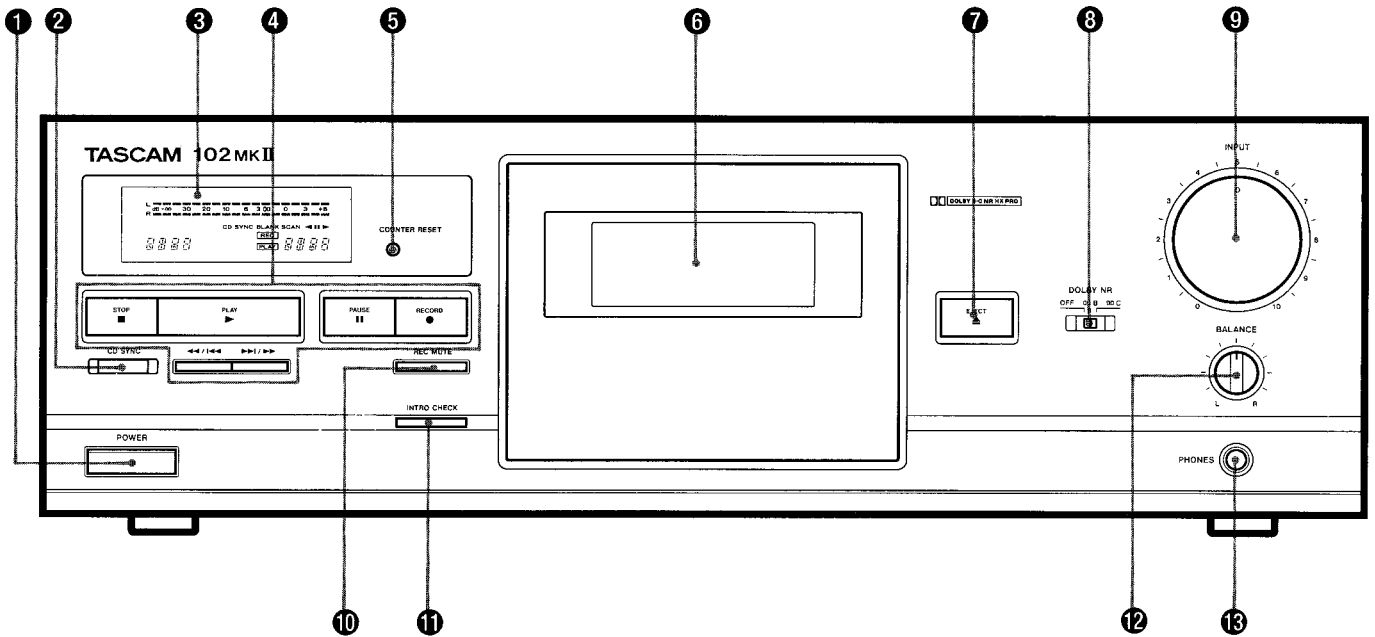

Display

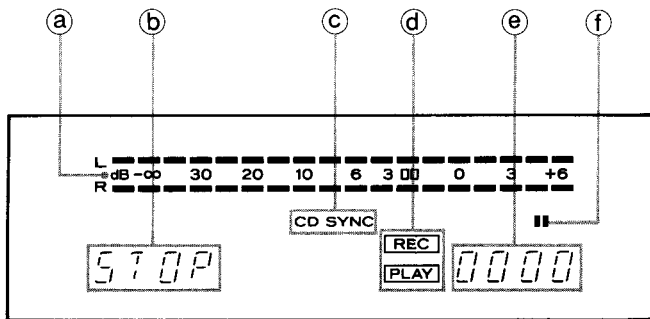

IN NORTH AMERICA USE ONLY ON 120 V SUPPLY.

DANS L'AMÉRIQUE DU NORD: UTILISABLE SUR 120 V D'ALIMENTATION UNIQUEMENT.

CONNECTIONS (Fig. 1)

- Turn off power for all equipment before making connections.
- Read instructions of each component you intend to use with the deck.

OUTPUT terminals

OUTPUT Terminals on the tape deck should be connected to the TAPE PLAY or LINE IN jacks on the amplifier/receiver.

LINE IN terminals

LINE IN Terminals on the tape deck should be connected to the REC OUT jacks on the amplifier/receiver.

Power cord

Be sure to connect the power cord to an AC outlet which supplies the correct voltage, as set by the voltage selector.

Fig. 1

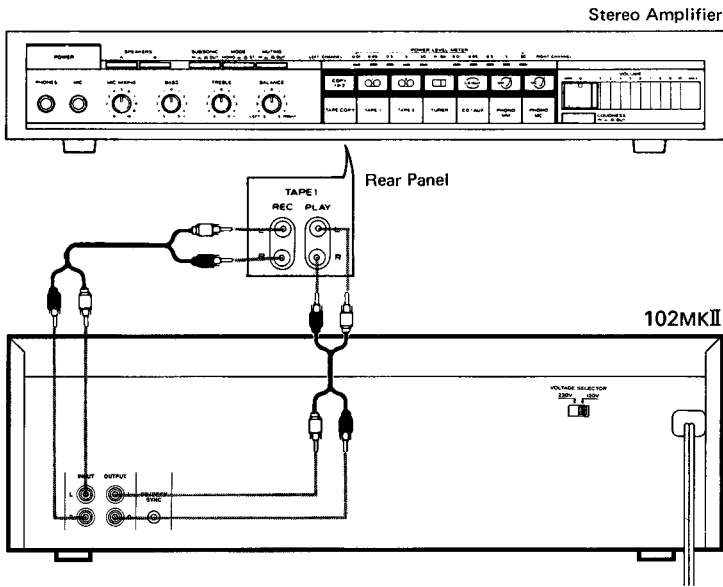

Fig. 2

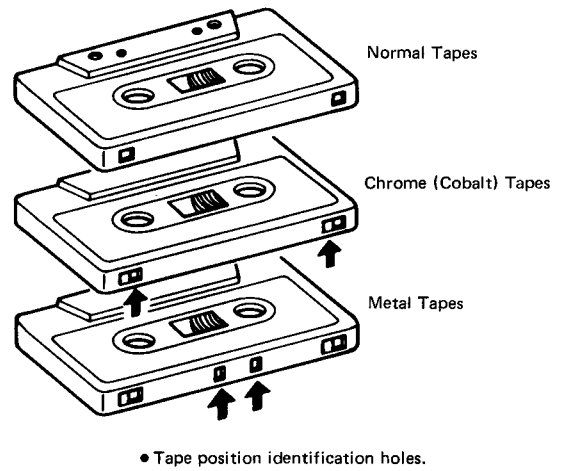

Fig. 3

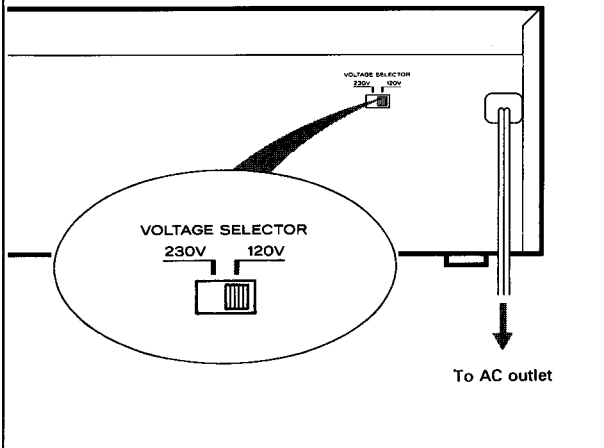

Fig. 4

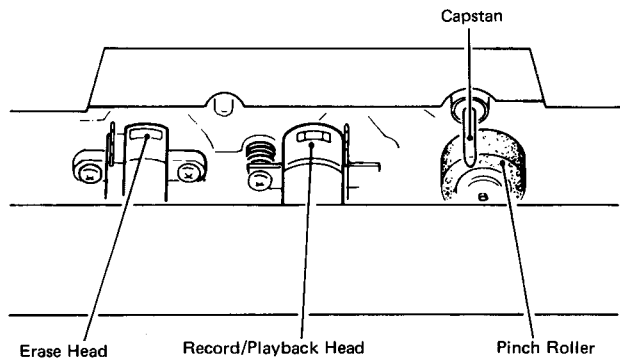
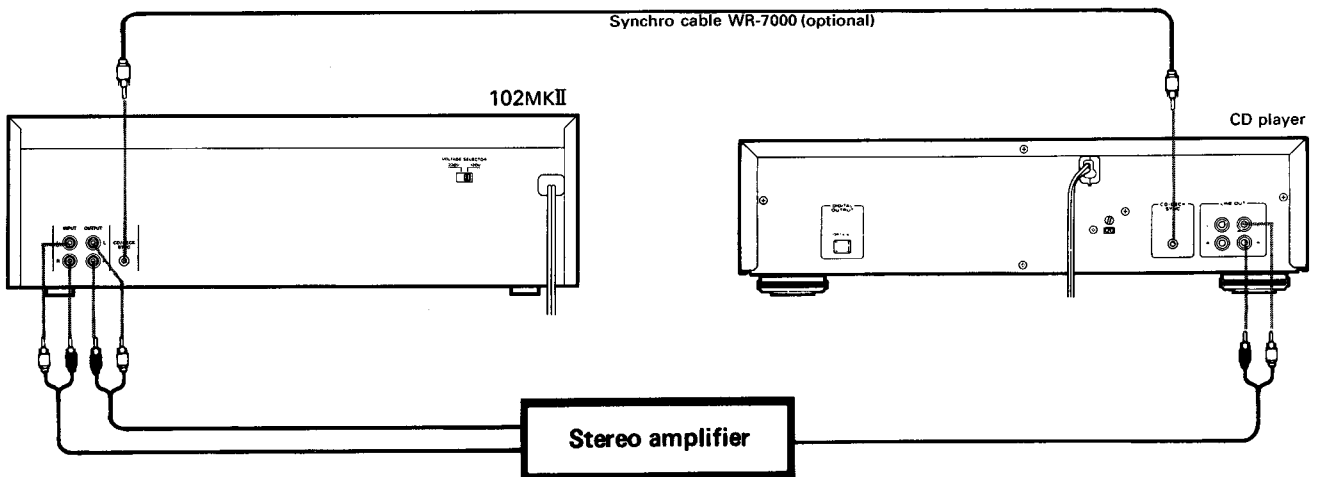

Fig. 5 Connection for CD synchro dubbing



PRECAUTIONS

Environment

Avoid using the deck in the following conditions:

- At high temperatures (near a heater, exposed to direct sunlight, etc.).
- At extremely low temperatures.
- Where there is excessive humidity.
- In a dusty atmosphere.
- Where power line voltage fluctuations are severe (in which case the use of a voltage regulator may be advisable).

Cassette Tape (Fig. 2)

Tape Selection:

For the automatic tape select function to work properly, metal and chrome (cobalt) tapes must have identification holes.

Tape Handling:

Do not store tapes in the following places:

- On top of heaters, exposed to direct sunlight or in any other places with high temperatures.
- Near speakers, on TV sets or amplifiers or where they would be exposed to strong magnetic fields.
- Where humidity is high and in dirty, dusty places.
- Avoid dropping or subjecting cassettes to excessive shocks.
- As C-120 tapes are physically weak and could become entangled in the transport mechanism, do not use them.

Voltage Conversion

(General export models only) (Fig. 3)

Be sure to remove the power cord from the AC outlet before repositioning the voltage converter switch.

1. Locate the voltage selector on the rear panel.
2. Using a flat-bladed screwdriver, set to the appropriate 230 V or 120 V position according to your area.

THE APPLIANCE CONFORMS WITH EEC DIRECTIVE 87/308/EEC REGARDING INTERFERENCE SUPPRESSION.

* Dolby noise reduction and HX Pro headroom extension manufactured under license from Dolby Laboratories Licensing Corporation. HX Pro originated by Bang & Olufsen. "DOLBY", the double-D symbol $\square\square$ and "HX PRO" are trademarks of Dolby Laboratories Licensing Corporation.

FEATURES AND CONTROLS

(See page 3.)

FRONT PANEL

① POWER Switch

Note: If you switch the power off, be sure to wait for more than 3 seconds before switching it on again.

② CD SYNC Button

③ Display Window

- Ⓐ Peak Level Meter
- Ⓑ Transport Mode Indicators
- Ⓒ CD SYNC Indicator
- Ⓓ REC/PLAY Mode Indicators
- Ⓔ Multi Counter
- Ⓕ Pause Indicator

④ Tape Operation Buttons

STOP Button

▶: Play Button

PAUSE Button

RECORD Button

◀◀ / ◀◀◀: Rewind/CPS Button

▶▶ / ▶▶▶: Fast Forward/CPS Button

⑤ COUNTER RESET Button

Pressing the COUNTER RESET Button resets the multi-counter to "0000".

⑥ Cassette Holder

⑦ EJECT Button

⑧ DOLBY NR Select Switch

OFF: Set to this position when you do not want to use any noise reduction system.

B: Set to this position when making a recording using the Dolby B noise reduction system, or playing back tapes recorded with Dolby B NR.

C: Set to this position when making a recording using the Dolby C noise reduction system, or playing back tapes recorded with Dolby C NR.

⑨ INPUT Control

⑩ REC (Record) MUTE Button

⑪ INTRO CHECK Button

⑫ BALANCE Control

⑬ PHONES Jack

Plug stereo headphones into this jack for private listening or monitoring.

IMPORTANT (for U.K. Customers)

DO NOT cut off the mains plug from this equipment. If the plug fitted is not suitable for the power points in your home or the cable is too short to reach a power point, then obtain an appropriate safety approved extension lead or consult your dealer.

If nonetheless the mains plug is cut off, remove the fuse and dispose of the plug immediately, to avoid a possible shock hazard by inadvertent connection to the mains supply.

If this product is not provided with a mains plug, or one has to be fitted, then follow the instructions given below:

IMPORTANT. DO NOT make any connection to the larger terminal which is marked with the letter E or by the safety earth symbol \perp or coloured GREEN or GREEN-and-YELLOW.

The wires in the mains lead on this product are coloured in accordance with the following code:

BLUE: NEUTRAL
BROWN: LIVE

As these colours may not correspond with the coloured markings identifying the terminals in your plug proceed as follows:

The wire which is coloured BLUE must be connected to the terminal which is marked with the letter N or coloured BLACK.

The wire which is coloured BROWN must be connected to the terminal which is marked with the letter L or coloured RED.

When replacing the fuse only a correctly rated approved type should be used and be sure to re-fit the fuse cover.

IF IN DOUBT — CONSULT A COMPETENT ELECTRICIAN.

OPERATIONS

Loading a Cassette Tape

1. Use your finger or a pencil to turn the cassette's hub and take up any slack tape.
Note: Avoid touching the tape. Fingerprints attract dust and dirt.
2. Press the eject button (▲)* to open the cassette compartment door.
3. Load the cassette tape with its open edge facing down.
4. Gently close the compartment door.

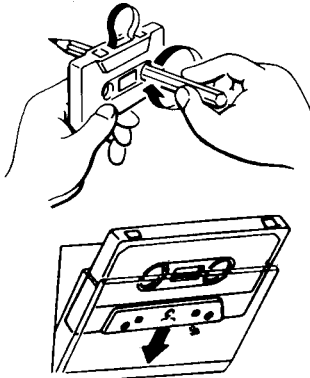

* Notes:

- The cassette holder cannot be opened during recording or playback.
- If the power has been switched off during play or recording, ejecting the cassette may be impossible. In such a case, switch the power on and press the eject button again.

Playback

1. Press the POWER switch to ON.
 2. Load a pre-recorded cassette.
 3. Set the DOLBY NR switch as required.
 4. Press the ► button to start playback.
 5. Adjust the volume with the amplifier's volume control.
- To stop playback, press the STOP button.

Transport Mode Indicators

Deck Operation	Indicators
Stop	STOP
Playback/Record	PLAY
Pause	PAUS
Fast-Forward	FF
Rewind	REW

INTRO CHECK Function

This function makes searching for a specific tune much easier by detecting the beginning of each tune in sequence.

1. Press the INTRO CHECK button.
2. The deck will fast-wind to the beginning of a tune, play the first 15

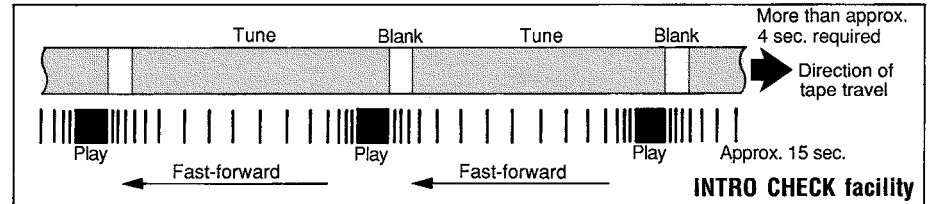

CPS (Computomatic Program Search) Function

CPS allows the selection and playback of any tune up to 20 tunes ahead or before the one being played. This function operates by detecting blank spaces of at least 4 seconds between tunes. These blanks can be created using the REC MUTE Function.

1. During playback, press the ◀◀ or ▶▶ button repeatedly until the number of tunes to be skipped appears in the counter display. Use the ▶▶ button for searching a tune following the current tune and ◀◀ button for a tune before the current tune. Refer to the chart "How to Select any Required Tune Using CPS".
- If, by using the ▶▶ the required CPS number setting is exceeded, use the ◀◀ button to count down the CPS number until the required CPS number is displayed.

seconds (approx.), then fast-wind to the beginning of the next tune, from which point the cycle starts again.

3. To release the intro check function, press the STOP button.
- When the ► (Play) button is pressed during the intro check mode, normal playback resumes.

- When the ▶▶ button is pressed, the next tune is counted as "1" and when the ◀◀ button is pressed, the current tune is counted as "1".
- 2. The tape is fast-wound to detect blanks between tunes until the required tune is reached. Then playback starts from the beginning of the designated tune.

Notes on CPS

CPS operates by detecting and counting blanks of about 4 seconds, the standard interval between tunes. Therefore, with the following types of tapes, search functions may not work correctly.

- When the intervals between tunes cannot be detected.
 - Intervals of less than 4 seconds.
 - High levels of noise in intervals.
 - Long low level sections (in classical music, etc.)

This problem can be corrected using the REC MUTE function.

How to Select any Required Tune Using CPS

Ex: See (1). To select the 3rd tune past the current tape position, select "CP03".

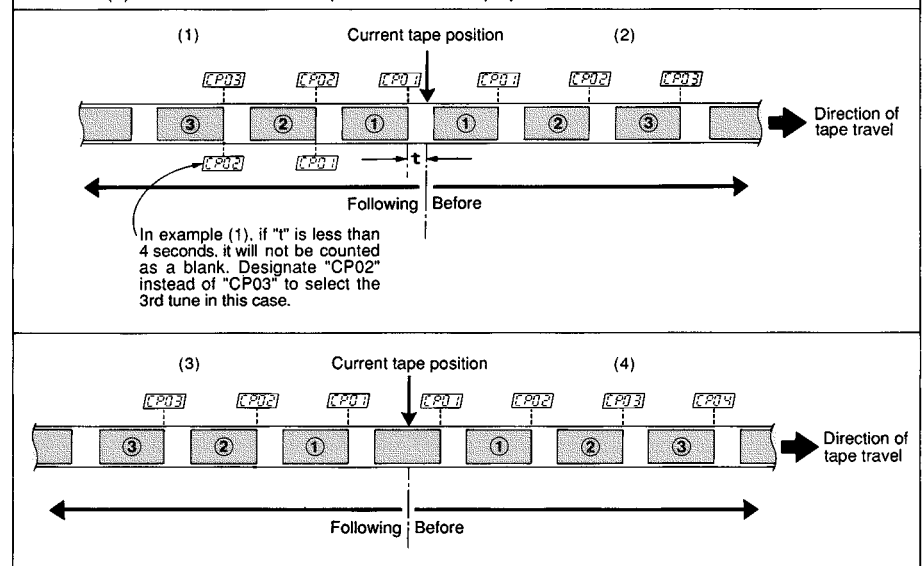

Recording

Recording from a stereo system:

1. Press the POWER switch to ON.
2. Load a recordable cassette.
3. Set the DOLBY NR switch as desired.
4. Press the RECORD button. The REC and ■ indicators will light to show that the deck is in the record-pause mode. This enables you to adjust the recording level without actually recording on the tape.
5. Adjust the recording level with the INPUT control so that the loudest sound to be recorded just makes the meters briefly reach around the "0 dB" point (for Normal or Chrome tapes) or the "+3 dB" point (for Metal tapes).
6. To adjust the balance of the left and right channel input signals, use the BALANCE control.
7. Press the ► or PAUSE button to start recording.

Notes:

- To stop recording, press the STOP button.
- To momentarily stop recording, press the PAUSE button. To resume recording, press the ► or PAUSE button.

CAUTION:

Recording pre-recorded tapes, records, or other published or broadcast material may infringe copyright laws. Check these laws before recording.

Erasing

Anything previously recorded on the tape will automatically be erased when you make a new recording on it. It can also be erased by "recording" on it with the INPUT control set to "0".

Record Muting Operation

1. Automatic spacing operation for 4-second blanks (during recording)

Press the REC MUTE button during recording. The tape movement continues and a blank space of about 4 seconds is recorded (the RECORD indicator blinks). The deck then enters the record-pause mode automatically (both the REC and ■ indicators light). To restart recording, press the PAUSE button (the ■ indicator goes off).

2. Automatic spacing operation for 4-second blanks (during record-pause)

In the record-pause mode, pressing the REC MUTE button will initiate the above record-muting operation automatically. The deck then returns to the record-pause mode.

3. For a blank of more than 4 seconds

During recording, hold the REC MUTE button depressed for longer than 4 seconds. A blank space will be left as long as the button is pressed. Release the button to enter the record-pause mode. To restart recording, press the PAUSE button.

4. For a blank of less than 4 seconds

After pressing the REC MUTE button during recording, press the PAUSE button before 4 seconds has elapsed. The deck will stop and enter the record-pause mode at the point at which the PAUSE button is pressed. To restart recording, press the PAUSE button again.

Note:

- During record muting operation (while the RECORD indicator is blinking), pressing the REC MUTE button again will release the record muting operation and recording will restart without stopping the tape.

CD Synchro Dubbing (Fig. 5)

By connecting the deck to a TEAC CD synchro compatible CD player which has a CD/DECK SYNC terminal on its rear panel, dubbing (recording) synchronized with the CD player is possible.

Preparation

1. Connect the deck's CD/DECK SYNC terminal to the CD player's CD/DECK SYNC terminal using an optional cable.
2. Perform programming of the "time edit", etc. functions of the CD player beforehand (refer to the instructions of the CD player).
3. Set the source to CD using the amplifier's source select buttons.
4. Set the recording level.
5. Set the deck and the CD player to the stop mode.
6. Press the CD SYNC button of the deck. The CD player will start automatically approx. 1 sec after the deck starts recording and dubbing will be performed. (The CD SYNC indicator lights.)

To stop temporarily during dubbing:

To temporarily stop CD synchro dubbing

- (A) Press the STOP button of the deck. The CD player will return to the beginning of the current tune and pause there. To restart, press the deck's CD SYNC button.
- (B) Press the stop button of the CD player. The deck enters the rec/pause mode. To restart, press the CD player's play button.

* When the CD player has entered the pause mode, it stands by after returning to the beginning of the tune that has just been played.

CD synchro dubbing operation

The shaded portions (■) in the following indicate the CD synchro dubbing mode.

Start of CD synchro dubbing

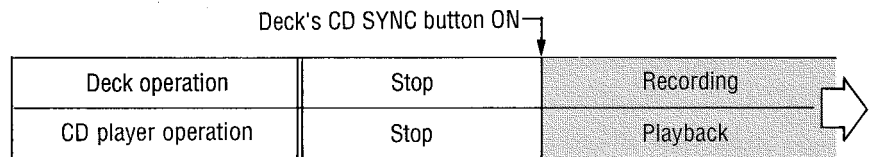

(A: Operation at the deck)

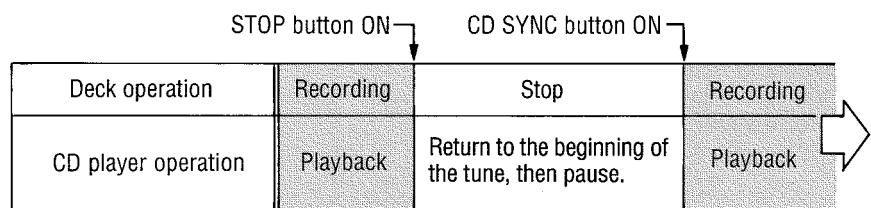

(B: Operation at the CD player)

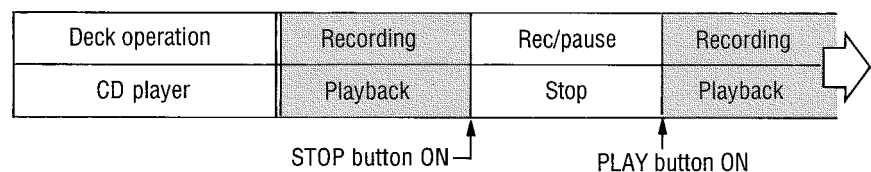

* When recording is done up to the end of the tape, the CD player stands by after returning to the beginning of the tune that has just been played.

Note

If the CD player is connected to the stereo amplifier using an optical cable, synchro dubbing is not possible. If synchro dubbing is required, you must connect the deck's analog output using pin plug cords.

MAINTENANCE (Fig. 4)

The heads and tape path should be cleaned and demagnetized periodically.

Cleaning Tape Path

- Apply head cleaning fluid* to a cotton bud or soft cloth, and lightly rub the heads, capstan and all metal parts in the tape path.
- Also clean the pinch roller using rubber cleaning fluid*.
- * Both are available in TEAC Tape Recorder Cleaning Kits HC-2 and RC-2 in the U.S.A. or TZ-261 in other areas.

Demagnetizing Heads

Be sure that the power is off, then demagnetize the heads using a TEAC E-3 demagnetizer. For details of its use, read its instructions.

TROUBLESHOOTING

Basic troubleshooting of a cassette tape deck is similar to troubleshooting any other electrical or electronic equipment. Always check the most obvious possible causes first. To give you a few ideas of what to look for, check the following:

- No power: Is the power cord connected?
- No audio output: Have all connections been made correctly?
- Low sound quality: Are the heads dirty or magnetized? Are you using good quality tape? Has the correct NR System been selected?
- Impossible to enter the record mode: Are the record protection tabs of the cassette in place?

DOLBY HX PRO

Dolby HX Pro is an "active bias" technique that can improve the quality of audio tape recordings. High-level high frequencies can be recorded more accurately, without sacrificing signal-to-noise ratio, while such side effects of tape saturation as distortion are reduced.

What Is Bias?

Bias is a very high-frequency signal generated within a tape deck and recorded on the tape simultaneously with the program material. This inaudible signal allows a low noise, low distortion recording and flat frequency response. Different magnetic tape formulations require different amounts of bias for optimum performance. If the bias level is too high, high-frequency Maximum Output Level (MOL) decreases.

The Problem of Self-Bias

Unfortunately, bias level is often influenced by the signal being recorded. The high frequencies contained in some music act as bias. This unpredictable source of bias is added to the existing bias, resulting in a loss of high-frequency response. As the high-frequency content of the signal increases, the ability of the recorder to record high frequencies (MOL) decreases. This phenomenon is called self-biasing.

How Dolby HX Pro Solution

The Dolby HX Pro monitors the high-frequency content of the program material and adjusts the recorder bias oscillator to maintain a constant total bias level. The result is improved high-frequency response and lower distortion. Depending on the type of tape, the improvement in headroom can be 6 dB or more.

The Benefits

With Dolby HX Pro, it is easier to make more accurate recordings of the kind of music which contains high-level high frequencies. The improvement is similar to that of high-performance tape over conventional tape, so regardless of the type of tape used, the results will sound better. Most important of all, Dolby HX Pro requires no decoding process. Once the tape is recorded with it, the improvements will be realized when playing the tape back on any machine.

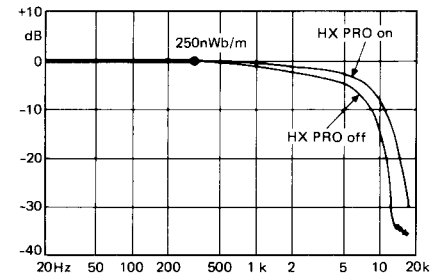

Example of improved frequency response using Dolby HX Pro

INSTALLING THE UNIT INTO A RACK

This unit is provided with a metal fixture for rack mounting. Use it when installing the unit into a 19-inch rack.

How to install

- (1) Remove four screws fixing the panel to the unit. (Do not open the panel.)
 - * Although the removed screws are not used to install the metal fixture for rack mounting, retain them for future use.
- (2) Place a metal fixture on the side of the unit (panel), then secure it using the provided four screws (M3 x 10).
- (3) In a similar way, install a metal fixture to the other side of the unit.
 - * See that the metal fixtures are flush with the top of the panel.

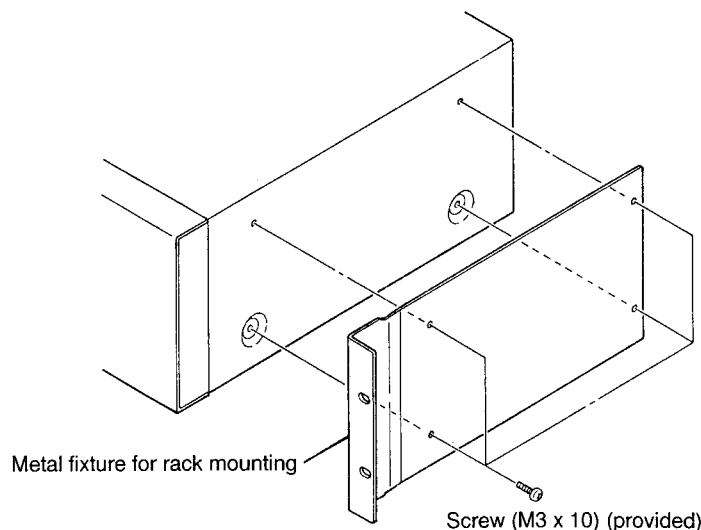

SPECIFICATIONS

Track System: 4-track, 2-channel stereo

Heads:

2; 1 Erase and 1 Record/Playback

Type of Tape: Cassette tape C-60 and C-90
(Philips type)

Tape Speeds: 4.76 cm/sec (1-7/8 ips)

Motor: 1 DC Servo motor

Wow and Flutter (WRMS): 0.06%

Frequency Response (Overall, -20 dB):

25 - 19,000 Hz, Metal tape

25 - 18,000 Hz, CrO2 tape

25 - 17,000 Hz, Normal tape

Signal-to-Noise Ratio (Overall):

59 dB (NR off, 3% THD Level,
Weighted)

69 dB (Dolby B NR on, over 5 kHz)

79 dB (Dolby C NR on, over 1 kHz)

Fast Winding Time: Approximately 110
seconds for C-60

Inputs: Line: 97 mV, 50k ohms

Outputs: Line: 0.52 V for load impedance of
50k ohms or more
Headphones: 1 mW/8 ohms

Power Requirements:

120/230 V AC, 50-60 Hz

(U.S.A./Canada/General Export
Model)

230 V AC, 50 Hz (Europe Model)

240 V AC, 50 Hz (UK/Australia
Model)

Power Consumption: 10 W

Dimensions (W x H x D):

435 x 144 x 286 mm

(17-1/8" x 5-11/16" x 11-1/4")

Weight (net): 4 kg (8-13/16 lbs.)

Standard Accessories: Input-output
connection cords

- Specifications were determined using metal tape except as noted.
- Improvements may result in specification or feature changing without notice.

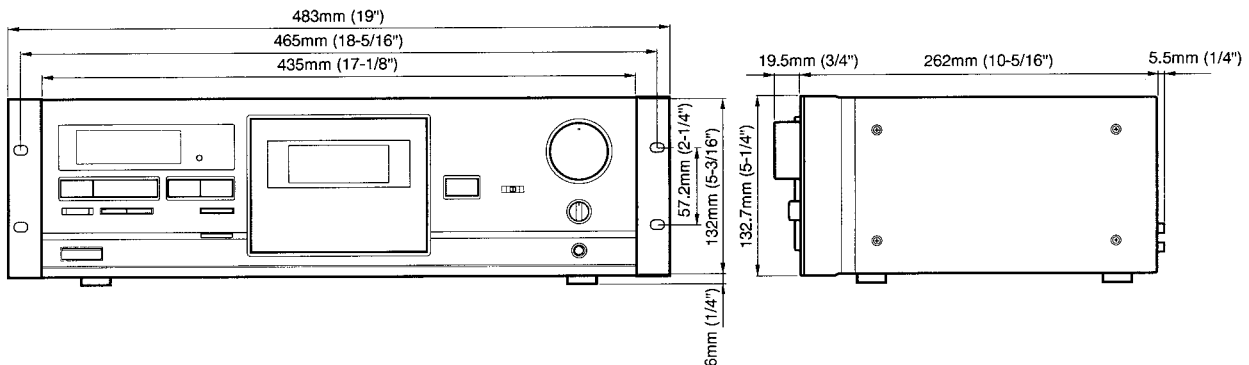

TASCAM

TEAC Professional Division

102MKII

For CANADA

THIS DIGITAL APPARATUS DOES NOT EXCEED THE CLASS B LIMITS FOR RADIO NOISE EMISSIONS FROM DIGITAL APPARATUS AS SET OUT IN THE RADIO INTERFERENCE REGULATIONS OF THE CANADIAN DEPARTMENT OF COMMUNICATIONS.

LE PRÉSENT APPAREIL NUMÉRIQUE N'ÉMET PAS DE BRUITS RADIOÉLECTRIQUES DÉPASSANT LES LIMITES APPLICABLES AUX APPAREILS NUMÉRIQUES DE CLASSE B PRÉSCRITES DANS LE RÉGLEMENT SUR LE BROUILLAGE RADIOÉLECTRIQUE ÉDICTÉ PAR LE MINISTÈRE DES COMMUNICATIONS DU CANADA.

For CANADA

AC POWER CORD CONNECTION

CAUTION :
TO PREVENT ELECTRIC SHOCK MATCH WIDE BLADE OF PLUG TO WIDE SLOT, FULLY INSERT.

CORDE DE CONNEXION CA

ATTENTION :
POUR ÉVITER LES CHOCS ÉLECTRIQUES, INTRODUIRE LA LAME LA PLUS LARGE DE LA FICHE DANS LA BORNE CORRESPONDANTE DE LA PRISE ET POUSSER JUSQU' AU FOND.

TEAC CORPORATION

3-7-3, Nakacho, Musashino-shi, Tokyo 180, Japan Phone: (0422) 52-5081

TEAC AMERICA, INC.

7733 Telegraph Road, Montebello, California 90640 Phone: (213) 726-0303

TEAC CANADA LTD.

340 Brunel Road, Mississauga, Ontario L4Z 2C2, Canada Phone: 905-890-8008

TEAC UK LIMITED

5 Marlin House, Marlin Meadow, The Croxley Centre, Watford, Herts. WD1 8YA, U.K. Phone: 0923-819631

TEAC DEUTSCHLAND GmbH

Bahnstrasse 12, 65205 Wiesbaden-Erbenheim, Germany Phone: 0611-71580

TEAC FRANCE S.A.

17, Rue Alexis-de-Tocqueville, CE 005 92182 Antony Cedex, France Phone: (1) 42.37.01.02

TEAC NEDERLAND BV

Perkinsbaan 11, 3439 ND Nieuwegein, Nederland Phone: 03-402-30229

TEAC AUSTRALIA PTY., LTD. A.C.N. 005 408 462

106 Bay Street, Port Melbourne, Victoria 3207, Australia Phone: (03) 646-1733

TEAC ITALIANA S.p.A.

Via C. Cantù 5, 20092 Cinisello Balsamo, Milano, Italy Phone: 02-66010500
