

Canon

Digital Video Camcorder Instruction Manual

English

Camescope vidéo numérique Manuel d'instruction

Français

Videocámara digital Manual de Instrucciones

Español

ELURA 70 / ELURA 65 / ELURA 60

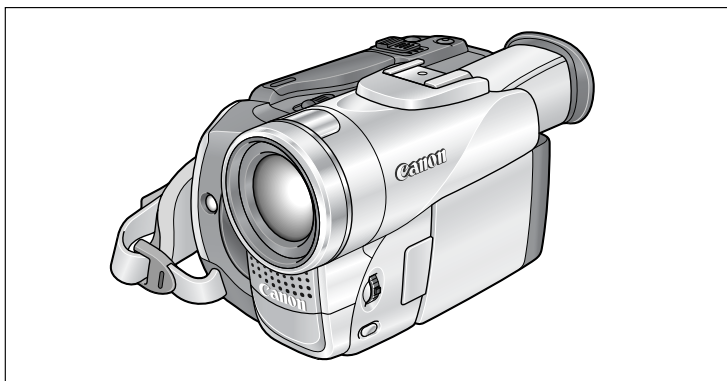

Mini **DV** Digital
Video
Cassette

BUBBLE JET
DIRECT

DIRECT
PRINT

PictBridge

Please read also the following instruction manuals.

Veuillez lire aussi les modes d'emploi suivants.

Lea también los manuales de instrucciones siguientes.

- Digital Video Software
- DV Network Software



NTSC

Important Usage Instructions

E

WARNING:



TO REDUCE THE RISK OF FIRE OR ELECTRIC SHOCK, DO NOT EXPOSE THIS PRODUCT TO RAIN OR MOISTURE.

WARNING:



TO REDUCE THE RISK OF ELECTRIC SHOCK AND TO REDUCE ANNOYING INTERFERENCE, USE THE RECOMMENDED ACCESSORIES ONLY.

COPYRIGHT WARNING:

Unauthorized recording of copyrighted materials may infringe on the rights of copyright owners and be contrary to copyright laws.

Digital Video Camcorder, ELURA70/ELURA65/ELURA60 systems

This device complies with Part 15 of the FCC Rules. Operation is subject to the following two conditions: (1) This device may not cause harmful interference, and (2) this device must accept any interference received, including interference that may cause undesired operation.

Note: This equipment has been tested and found to comply with the limits for class B digital device, pursuant to Part 15 of the FCC Rules. These limits are designed to provide reasonable protection against harmful interference in a residential installation. This equipment generates, uses and can radiate radio frequency energy and, if not installed and use in accordance with the instructions, may cause harmful interference to radio communications. However, there is no guarantee that interference will not occur in a particular installation. If this equipment does cause harmful interference to radio or television reception, which can be determined by turning the equipment off and on, the user is encouraged to try to correct the interference by one or more of the following measures:

- Reorient or relocate the receiving antenna.
- Increase the separation between the equipment and receiver.
- Connect the equipment into an outlet on a circuit different from that to which the receiver is connected.
- Consult the dealer or an experienced radio/TV technician for help.

Use of shielded cable is required to comply with class B limits in Subpart B of Part 15 of FCC Rules.

Do not make any changes or modifications to the equipment unless otherwise specified in the manual.

If such changes or modifications should be made, you could be required to stop operation of the equipment.

Canon U.S.A. Inc.

One Canon Plaza, Lake Success, NY 11042, U.S.A.

Tel No. (516)328-5600

CAUTION:

TO PREVENT ELECTRIC SHOCK, MATCH WIDE BLADE OF PLUG TO WIDE SLOT, FULLY INSERT.

Important Warning



The lightning flash with arrowhead symbol, within an equilateral triangle, is intended to alert the user to the presence of uninsulated "dangerous voltage" within the product's enclosure, that may be of sufficient magnitude to constitute a risk of electric shock to persons.

CAUTION:

TO REDUCE THE RISK OF ELECTRIC SHOCK, DO NOT REMOVE COVER (OR BACK). NO USER-SERVICEABLE PARTS INSIDE. REFER SERVICING TO QUALIFIED SERVICE PERSONNEL.



The exclamation point, within an equilateral triangle, is intended to alert the user to the presence of important operating and maintenance (servicing) instructions in the literature accompanying the product.

IMPORTANT SAFETY INSTRUCTIONS

In these safety instructions the word “product” refers to the Canon Digital Video Camcorder ELURA70/ELURA65/ELURA60 A and all its accessories.

1. Read Instructions — All the safety and operating instructions should be read before the product is operated.
 2. Retain Instructions — The safety and operating instructions should be retained for future reference.
 3. Heed Warnings — All warnings on the product and in the operating instructions should be adhered to.
 4. Follow Instructions — All operating and maintenance instructions should be followed.
 5. Cleaning — Unplug this product from the wall outlet before cleaning. Do not use liquid or aerosol cleaners. The product should be cleaned only as recommended in this manual.
 6. Accessories — Do not use accessories not recommended in this manual as they may be hazardous.
 7. Avoid magnetic or electric fields — Do not use the camera close to TV transmitters, portable communication devices or other sources of electric or magnetic radiation. They may cause picture interference, or permanently damage the camera.
 8. Water and Moisture — Hazard of electric shock — Do not use this product near water or in rainy/moist situations.
 9. Placing or Moving — Do not place on an unstable cart, stand, tripod, bracket or table. The product may fall, causing serious injury to a child or adult, and serious damage to the product.
A product and cart combination should be moved with care. Quick stops, excessive force, and uneven surfaces may cause the product and cart combination to overturn.
- 
10. Power Sources — The CA-570 Compact Power Adapter should be operated only from the type of power source indicated on the marking label. If you are not sure of the type of power supply to your home, consult your product dealer or local power company. Regarding other power sources such as battery power, refer to instructions in this manual.
 11. Polarization — The CA-570 Compact Power Adapter is equipped with a polarized 2-prong plug (a plug having one blade wider than the other).
The 2-prong polarized plug will fit into the power outlet only one way. This is a safety feature. If you are unable to insert the plug fully into the outlet, try reversing the plug. If the plug still fails to fit, contact your electrician to replace your obsolete outlet. Do not defeat the safety purpose of the polarized plug.
 12. Power Cord Protection — Power cords should be routed so that they are not likely to be walked on or pinched by items placed upon or against them. Pay particular attention to plugs and the point from which the cords exit the product.
 13. Outdoor Antenna Grounding — If an outside antenna is connected to the product, be sure the antenna is grounded so as to provide some protection against voltage surges and built-up static charges. Section 810 of the National Electrical Code, ANSI / NFPA No. 70—1984, provides information with respect to proper grounding of the mast and supporting structure, grounding of the lead-in wire to an antenna discharge unit, size of grounding conductors, location of antenna discharge unit, connection to grounding electrodes, and requirements for the grounding electrode. See figure 1.

E

Introduction

Fig. 1

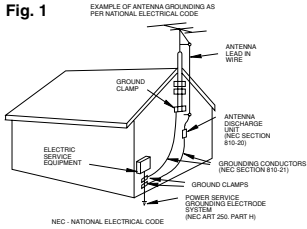

14. Lightning — For added protection of this product during a lightning storm, or when it is left unattended and unused for long periods of time, disconnect it from the wall outlet and disconnect the antenna. This will prevent damage to the product due to lightning and power-line surges.
15. Overloading — Do not overload wall outlets and extension cords as this can result in a risk of fire or electric shock.
16. Objects and Liquid Entry — Never push objects of any kind into this product through openings as they may touch dangerous voltage points or short out parts that could result in a fire or electric shock. Be careful not to spill liquid of any kind onto the product.
17. Servicing — Do not attempt to service this product yourself as opening or removing covers may expose you to dangerous voltage or other hazards. Refer all servicing to qualified service personnel.
18. Damage Requiring Service — Disconnect this product from the wall outlet and all power sources including battery, and refer servicing to qualified service personnel under the following conditions:
 - a. When the power-supply cord or plug is damaged.
 - b. If any liquid has been spilled onto, or objects have fallen into, the product.
 - c. If the product has been exposed to rain or water.
 - d. If the product does not operate normally even if you follow the operating instructions. Adjust only those controls that are covered by the operation instructions. Improper adjustment of other controls may result in damage and will often require extensive work by a qualified technician to restore the product to its normal operation.
 - e. If the product has been dropped or the cabinet has been damaged.
 - f. When the product exhibits a distinct change in performance. This indicates a need for service.
19. Replacement Parts — When replacement parts are required, be sure the service technician has used replacement parts that are specified by Canon or that have the same characteristics as the original part. Unauthorized substitutions may result in fire, electric shock or other hazards.
20. Safety Check — Upon completion of any service or repairs to this product, ask the service technician to perform safety checks to determine that the product is in safe operating order.

When replacement of power supply is required, please return it to the responsible nearest Canon Service Center and please replace it with the same type number CA-570.

The Adapter can be used with a power supply between 100 and 240 V AC. For areas where 120 V AC power is not used, you will need a special plug adapter. Contact your nearest Canon Service Center for further information.

Use only CSA/UL Certified power supply cord set, Polarized, Type SPT-2 or heavier, minimum No. 18 AWG copper, rated 125 or 250 V, minimum ,P A, minimum 6 ft (1.8 m), maximum 10 ft (3 m) long.



Using this Manual

Thank you for purchasing the Canon ELURA70/ELURA65/ELURA60. Please read this manual carefully before you use the camcorder and retain it for future reference.

Change the display language before you begin (76).

E

Symbols and References Used in This Manual

-  : Precautions related to the camcorder operation.
-  : Additional topics that complement the basic operating procedures.
-  : Reference page number.
- Capital letters are used to refer to buttons on the camcorder or the wireless controller.
- [] are used to refer to menu items displayed on the screen.
- "Screen" refers to the LCD and the viewfinder screen.
- Please note that the illustrations mainly refer to the ELURA70 (illustrations of the battery pack show the NB-2LH supplied with the ELURA65 and ELURA60).





Introduction

Operating modes (see below)

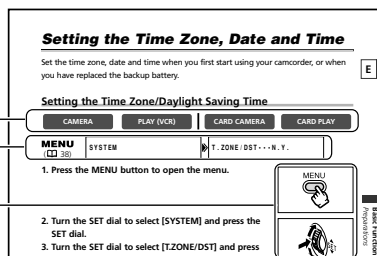
Menu item and its default setting.

Button and switches to be operated



Operating Mode	POWER Switch	TAPE/CARD Switch
CAMERA	CAMERA	 (TAPE)
PLAY (VCR)	PLAY (VCR)	 (TAPE)
CARD CAMERA	CAMERA	 (CARD)
CARD PLAY	PLAY (VCR)	 (CARD)

CAMERA : Function can be used in this mode.

CAMERA : Function cannot be used in this mode.

Trademark Acknowledgements

- Canon and Bubble Jet are registered trademarks of Canon Inc.
- Mini **IX** is a trademark.
- **SD** is a trademark.
- Windows® is either a registered trademark or trademark of Microsoft Corporation in the United States and/or other countries.
- Macintosh and Mac OS are trademarks of Apple Computer, Inc., registered in the United States and other countries.
- Other names and products not mentioned above may be registered trademarks or trademarks of their respective companies.

Table of Contents

Introduction

Important Usage Instructions	2
Important Safety Instructions	3
Using this Manual	5
Checking Supplied Accessories	8
Components Guide	9

Basic Functions

Preparations

Preparing the Power Supply	13
Loading/Unloading a Cassette	16
Installing the Backup Battery	17
Preparing the Camcorder	18
Using the Wireless Controller	20
Setting the Time Zone, Date and Time	21

Recording

Recording Movies on a Tape	24
Zooming	29
Tips for Making Better Videos	31

Playback

Playing Back a Tape	32
Adjusting the Volume	34
Playing Back on a TV Screen	35

Advanced Functions

Menus and Settings	38
--------------------------	----

Recording

Using the Recording Programs	45
Using the Night Modes	48
Skin Detail Function	50
Adjusting Exposure Manually	51
Adjusting the Focus Manually	52
Setting the White Balance	54
Setting the Shutter Speed	56
Using the Self-Timer	58
Changing the Recording Mode (SP/LP)	59
Audio Recording	60
Using Digital Effects	62

Playback

Magnifying the Image	69
Displaying the Data Code	70
End Search	72
Returning to a Pre-marked Position	73
Date Search	74

Other Functions

Customizing the Camcorder	75
---------------------------------	----

Changing the Display Language	76
Changing the Remote Sensor Mode	77
Other Camcorder Settings	78
ELURA 70/ELURA 65 Using the VFL-1 Video Flash Light (Optional)	80

Editing

Recording to a VCR or Digital Video Device	82
Recording from Analog Video Devices (VCR, TV or Camcorder)	84
Recording from Digital Video Devices (DV Dubbing).....	85
Converting Analog Signals into Digital Signals (Analog-Digital Converter)	86
Audio Dubbing	88
Connecting to a Computer Using a DV (IEEE1394) Cable	91

Using a Memory Card

Inserting and Removing a Memory Card	92
Selecting the Image Quality/Size	93
File Numbers	95
Recording Still Images on a Memory Card	96
Reviewing a Still Image Right after Recording	100
Recording Motion JPEG Movies on a Memory Card.....	101
Selecting the Focusing Point	103
Selecting the Drive Mode	104
Recording Panoramic Images (Stitch Assist Mode)	106
Playing Back a Memory Card	108
Protecting Images	111
Erasing Images	112
Combining Images (Card Mix)	113
Formatting a Memory Card	117
Creating a Start-up Image	118

Direct Printing

Printing Still Images.....	119
Selecting the Print Settings.....	122
Trimming Settings	127
Printing with Print Order Settings.....	128









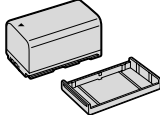
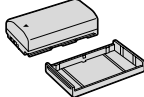

Transferring Images

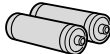
Connecting to a Computer Using a USB Cable	130
Direct Transfer [Windows OS Only]	131
Selecting Images for Transfer (Transfer Order)	134

Additional Information

About the NETWORK Mode	135
Screen Displays	136
List of Messages	139
Maintenance/Others	142
Troubleshooting	148
System Diagram	151
Optional Accessories	152
Specifications	155
Item Codes	157
Index	158

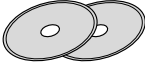
Checking Supplied Accessories

<p>CA-570 Compact Power Adapter (incl. power cord)</p> 	<p>ELURA 70 BP-2L14 Battery Pack</p> 	<p>ELURA 65/ELURA 60 NB-2LH Battery Pack</p> 	<p>Lithium Button Battery CR1616</p> 
<p>WL-D83 Wireless Controller</p> 	<p>Two AA (R6) Batteries</p> 	<p>Lens Cap and Lens Cap Cord</p> 	<p>SS-900 Shoulder Strap</p> 
<p>STV-250N Stereo Video Cable</p> 	<p>IFC-300PCU USB Cable</p> 	<p>SDC-8M SD Memory Card (containing sample images)</p> 	<p>DIGITAL VIDEO SOLUTION DISK For Windows For Macintosh</p> 
<p>ELURA 70 WA-34 Wide Attachment</p> 			

The serial number of this product can be found at the battery attachment unit of the camcorder. Write down the number and other information here and retain this book as a permanent record of your purchase to aid identification in case of theft.

Date of Purchase:

Model Name: ELURA70/ELURA65/ELURA60 A

Purchased From:

Serial No.:

Dealer Address:

Dealer Phone No.:

Components Guide

ELURA70/ELURA65/ELURA60

E

Introduction

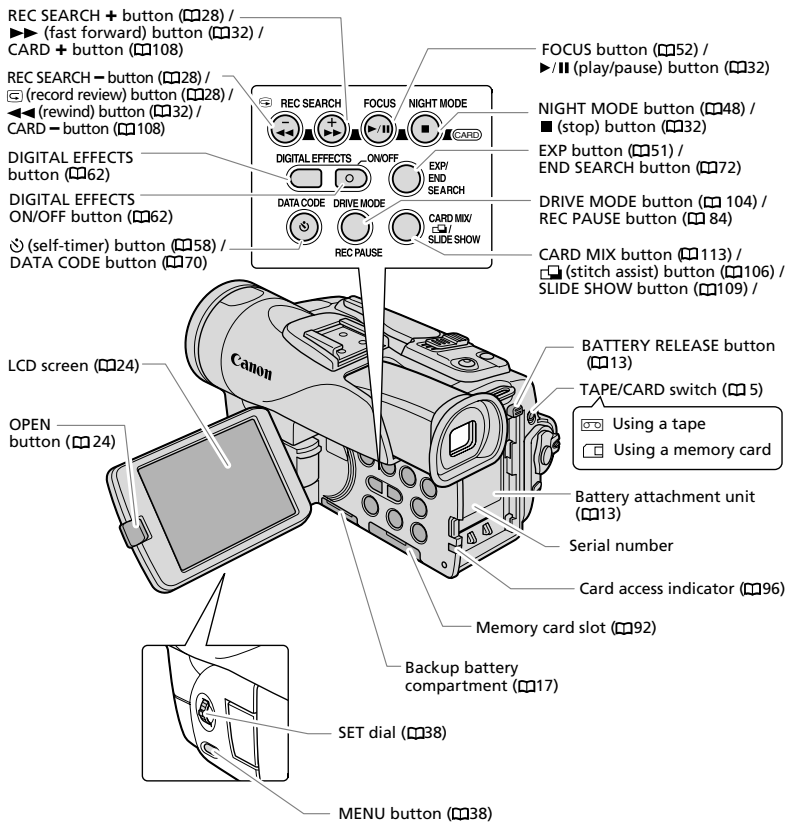

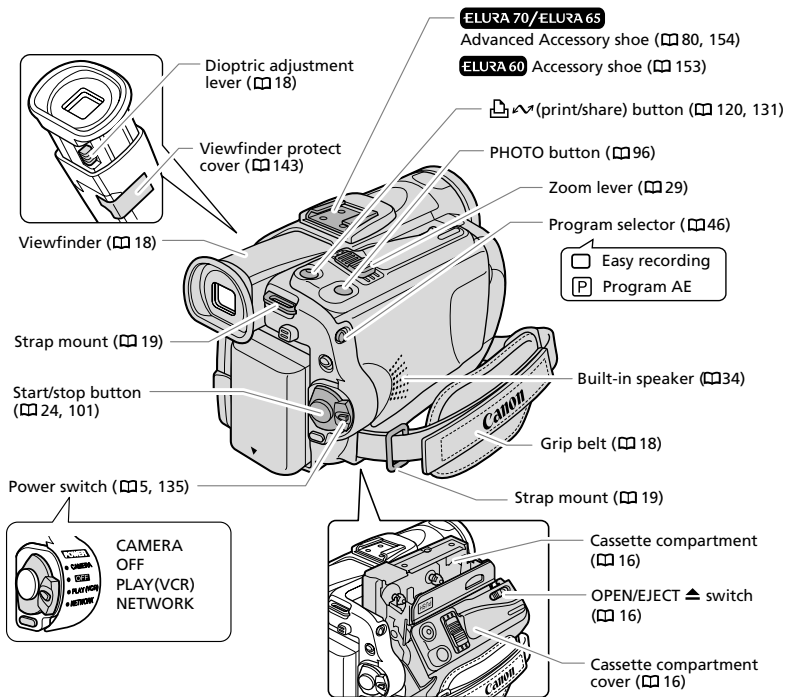

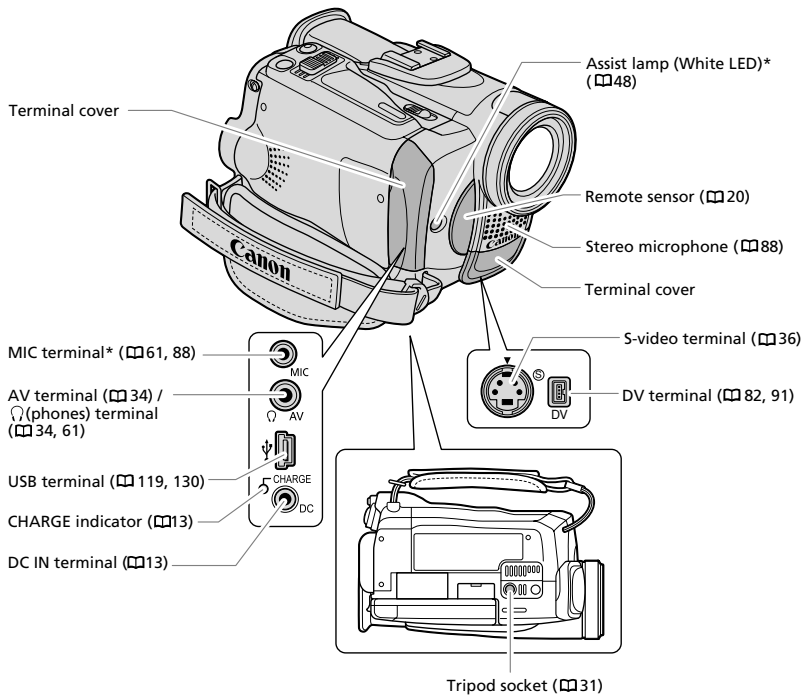

* ELURA70/ELURA65 only.

WL-D83 Wireless Controller

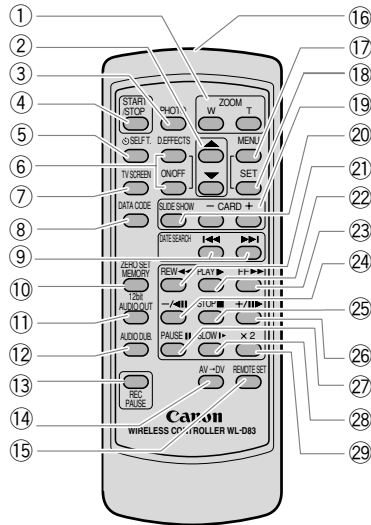

- ① Zoom buttons (㉑ 29)
- ② Select buttons (㉑ 38)
- ③ PHOTO button (㉑ 96)
- ④ START/STOP button (㉑ 24, 101)
- ⑤ Ⓢ SELF T. button (㉑ 58)
- ⑥ D. EFFECTS button, ON/OFF button (㉑ 62)
- ⑦ TV SCREEN button (㉑ 136)
- ⑧ DATA CODE button (㉑ 70)
- ⑨ DATE SEARCH ⏪/⏩ buttons (㉑ 74)
- ⑩ ZERO SET MEMORY button (㉑ 73)
- ⑪ 12bit AUDIO OUT button (㉑ 90)
- ⑫ AUDIO DUB. button (㉑ 89)
- ⑬ REC PAUSE button (㉑ 84)
- ⑭ AV → DV button (㉑ 87)
- ⑮ REMOTE SET button (㉑ 77)

- ⑯ Transmitter
- ⑰ MENU button (㉑ 38)
- ⑱ SET button (㉑ 38)
- ⑲ CARD -/+ buttons (㉑ 108)
- ⑳ SLIDE SHOW button (㉑ 109)
- ㉑ REW ⏪ button (㉑ 32)
- ㉒ PLAY ⏩ button (㉑ 32)
- ㉓ FF ⏩ button (㉑ 32)
- ㉔ -/⏪ button (㉑ 33)
- ㉕ STOP ■ button (㉑ 32)
- ㉖ +/⏩ button (㉑ 33)
- ㉗ PAUSE ⏸ button (㉑ 33)
- ㉘ SLOW ▶ button (㉑ 33)
- ㉙ x 2 button (㉑ 33)

Preparing the Power Supply

Attaching the Battery Pack

1. Turn the **POWER** switch to **OFF**.
2. Move the viewfinder upward.
3. Attach the battery pack to the camcorder.
 - Remove the terminal cover of the battery pack.
 - Press lightly and slide it in the direction of the arrow until it clicks.

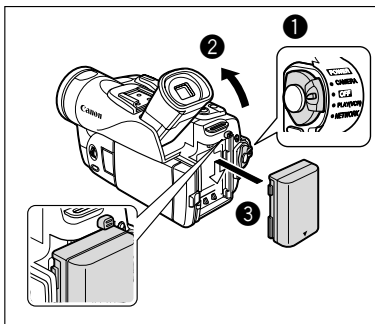

Charging the Battery Pack

1. Connect the power cord to the adapter.
2. Plug the power cord into a power outlet.
3. Connect the power adapter to the camcorder's DC IN terminal.

The CHARGE indicator starts flashing. It glows steadily when charging is complete.

4. When charging is complete, disconnect the power adapter from the camcorder. Unplug the power cord from the power outlet and disconnect it from the adapter.
5. Remove the battery pack after use.

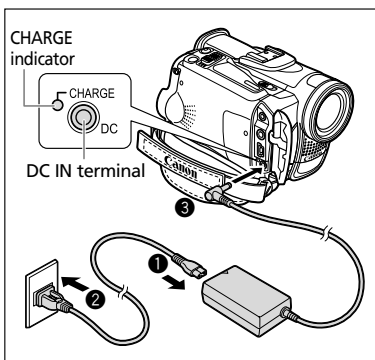

Press the **BATTERY RELEASE** button to remove the battery.

Using a Household Power Source

The LCD screen's backlight is brighter when the camcorder is powered from a household power source.

1. Turn the **POWER** switch to **OFF**.
2. Connect the power cord to the power adapter.
3. Plug the power cord into a power outlet.
4. Connect the power adapter to the camcorder's DC IN terminal.

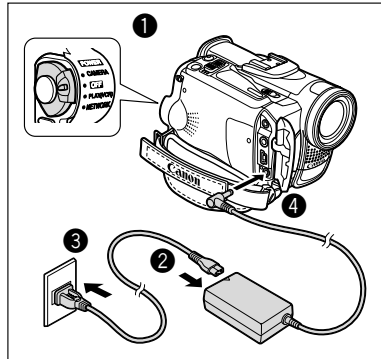

- Turn off the camcorder before connecting or disconnecting the power adapter.
- If the adapter is used close to a TV, it may cause picture interference. Move the adapter away from the TV or the antenna cable.
- Do not connect any products that are not expressly recommended to the camcorder's DC IN terminal or to the power adapter.
- You may hear some noise from the power adapter during use. This is not a malfunction.
- Do not disconnect and reconnect the power cord while charging a battery pack. Charging may stop. The battery pack may not be charged correctly even if the CHARGE indicator glows steady. The battery pack may also not be charged correctly when a power outage occurs during charging. Remove the battery pack and attach it back to the camcorder.



- When the power adapter or battery pack is defective, the CHARGE indicator flashes rapidly (at about 2 flashes/second) and charging stops.
- The CHARGE indicator informs you about the charge status.
 - 0-50%: Flashes once every second
 - More than 50%: Flashes twice every second
 - 100%: Glows steadily

○ Charging, Recording and Playback Times

Below times are approximate and vary according to the charging, recording or playback conditions.

		BP-2L14	NB-2LH	NB-2L	BP-2L12
Charging Time		210 min.	115 min.	110 min.	180 min.
Max. Recording Time	Viewfinder	240 min.	115 min.	95 min.	200 min.
	LCD	190 min.	90 min.	75 min.	150 min.
Typical Recording Time*	Viewfinder	135 min.	65 min.	50 min.	110 min.
	LCD	105 min.	50 min.	40 min.	85 min.
Playback Time		220 min.	105 min.	85 min.	175 min.

* Approximate times for recording with repeated operations such as start/stop, zooming, power on/off. Actual time may be shorter.

- We recommend charging the battery pack in temperatures between 50 °F and 86 °F (10 °C and 30 °C). Outside the temperature range of 32 °F to 104 °F (0 °C to 40 °C), the CHARGE indicator flashes rapidly and charging stops.
- A lithium ion battery pack can be charged at any charge state. Unlike conventional battery packs, you do not need to completely use or discharge it before charging.
- We recommend that you prepare battery packs 2 to 3 times longer than you think you might need.
- To conserve battery charge, turn off the camcorder instead of leaving it in record pause mode.

Loading/Unloading a Cassette

Use only videocassettes marked with the Mini DV logo.

1. Slide and hold the OPEN/EJECT switch and open the cassette compartment cover.

The cassette compartment opens automatically.

2. Load/unload the cassette.

- Load the cassette with the window facing the grip belt.
- Unload the cassette by pulling it straight out.

3. Press the **PUSH mark on the cassette compartment until it clicks.**

4. Wait for the cassette compartment to retract automatically and close the cassette compartment cover.

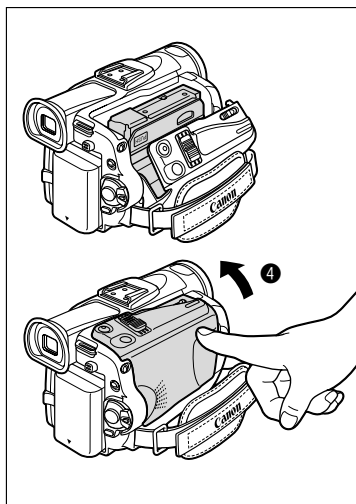
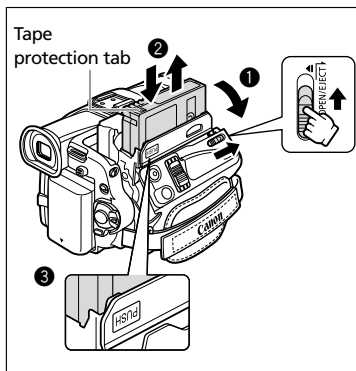

○ Do not interfere with the cassette compartment while it is opening or closing automatically, or attempt to close the cover before the cassette compartment has fully retracted.

○ Be careful not to get your fingers caught in the cassette compartment cover.



If the camcorder is connected to a power source, cassettes can be loaded/unloaded even if the POWER switch is set to OFF.

Installing the Backup Battery

The backup battery allows the camcorder to retain date, time (📅 21) and other camcorder settings while the power source is disconnected. Connect a power source to the camcorder when replacing the backup battery to retain the settings.

E

1. Press the **OPEN** button to open the LCD panel.
2. Pull out the battery holder.
3. Place the lithium battery with the **+** side facing downward into the battery holder.

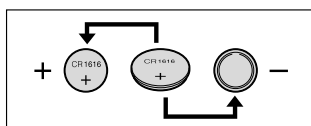

4. Insert the battery holder.
5. Close the LCD panel.

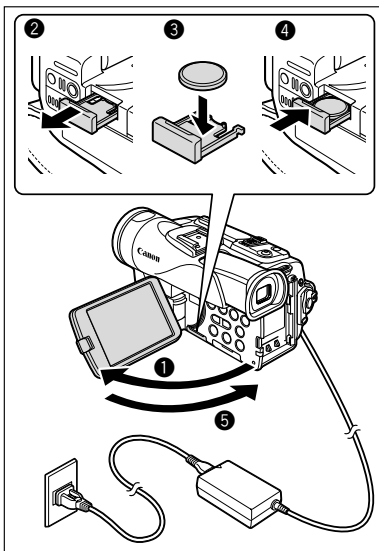

Basic Functions -
Preparations

WARNING!

- The battery used in this device may present a fire or chemical burn hazard if mistreated. Do not recharge, disassemble, heat above 212 °F (100 °C) or incinerate the battery.
- Replace the battery with a CR1616 made by Panasonic, Hitachi Maxell, Sony, Toshiba, Varta or Renata. Use of other batteries may present a risk of fire or explosion.



- Do not pick up the battery using tweezers or other metal tools as this will cause a short circuit.
- Wipe the battery with a clean dry cloth to ensure proper contact.
- Keep the battery out of reach of children. If it is swallowed, seek medical assistance immediately. The battery case may break and the battery fluids may damage stomach and intestines.
- Do not disassemble, heat or immerse the battery in water to avoid the risk of explosion.



The backup battery has a life span of about a year. ⚡ flashes in red to inform you that it needs to be replaced.

Preparing the Camcorder

Adjusting the Viewfinder (Dioptric Adjustment)

1. Turn on the camcorder and keep the LCD panel closed.
2. Pull out the viewfinder.
3. Adjust the dioptric adjustment lever.

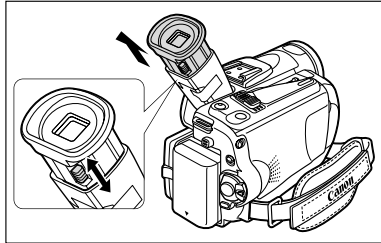

Attaching the Lens Cap

1. Attach the cord to the lens cap.
2. Pass the grip belt through the loop on the cord.

Press the buttons on the lens cap when attaching/removing it. Hook the lens cap on the grip belt while you are recording, and place it over the lens when you have finished.

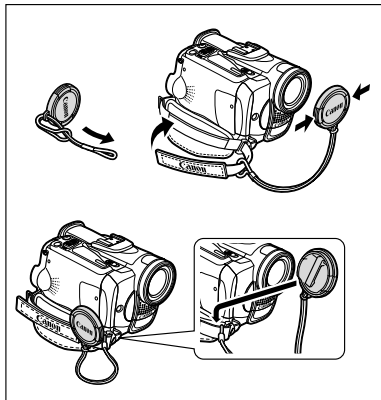

Fastening the Grip Belt

Hold the camcorder with your right hand and adjust the belt with your left.

Adjust the grip belt so that you can reach the zoom lever with your index finger, and the start/stop button with your thumb.

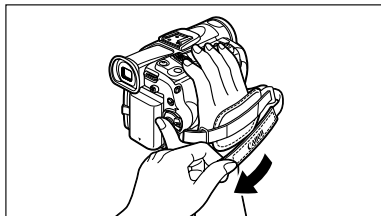

Attaching the Shoulder Strap

Pass the ends through the strap mount and adjust the length of the strap.

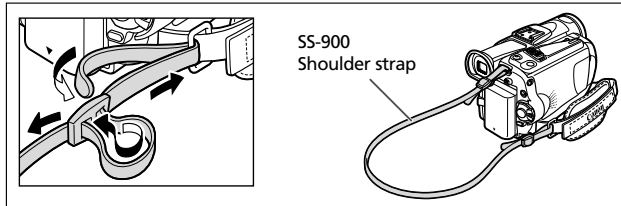

E

ELURA 70 Mounting the Wide Attachment

The WA-34 Wide Attachment gives you a wide perspective for indoor shots or panoramic views (0.7x). The wide attachment is for use at maximum wide-angle.

Screw the wide attachment fully into the lens filter thread.

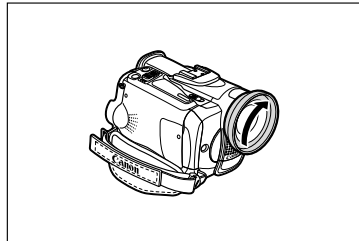

Basic Functions -
Preparations



- Do not look directly at the sun or other strong light sources through the wide attachment. It could damage your eyesight.
- If you zoom to telephoto, the picture will not be in focus.
- If dust accumulates on the wide attachment or on the camcorder lens, clean both lenses gently with a blower brush.
- Do not touch the lens to avoid smudges and fingerprints.
- Do not store the wide attachment in a humid place as it may mold.



- The wide attachment may obstruct the remote sensor (the range of the wireless controller narrows), or may cause a shadow to appear on the picture when recording with flash, video light or the assist lamp (White LED).
- Filters cannot be used with the wide attachment.

Using the Wireless Controller

Point it at the camcorder's remote sensor when you press the buttons.

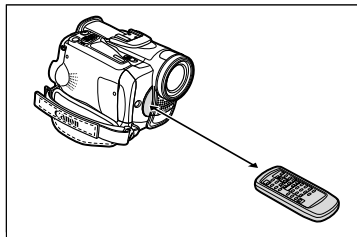

Inserting Batteries

The wireless controller operates with two AA (R6) batteries.

1. **Open the battery cover.**
2. **Insert the batteries following the + and – markings.**
Replace both batteries.
3. **Close the battery cover.**

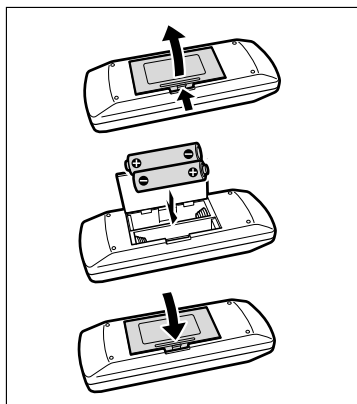

- Camcorder and wireless controller are equipped with 2 remote sensor modes (77). If the wireless controller does not work, check if camcorder and wireless controller are set to the same mode.
- The wireless controller may not work properly when the remote sensor is subjected to strong light sources or direct sunlight.

Setting the Time Zone, Date and Time

Set the time zone, date and time when you first start using your camcorder, or when you have replaced the backup battery.

E

Setting the Time Zone/Daylight Saving Time



1. Press the MENU button to open the menu.

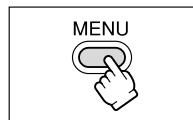

2. Turn the SET dial to select [SYSTEM] and press the SET dial.
3. Turn the SET dial to select [T.ZONE/DST] and press the SET dial.

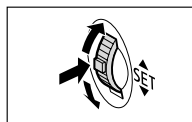

The time zone setting appears (see table on the next page). The default setting is New York.

4. Turn the SET dial to select the setting option that represents your time zone and press the SET dial.

To adjust for daylight saving time, select the time zone with the ☀ next to the area.

Setting the Date and Time

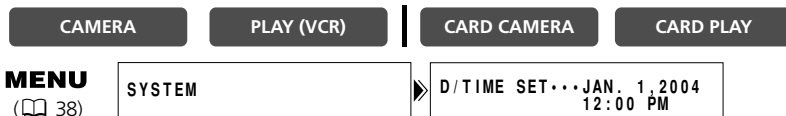

5. Turn the SET dial to select [D/TIME SET] and press the SET dial.
6. Turn the SET dial to select the year, and press the SET dial.

The year display starts to flash.

- The next part of the display starts flashing.
- Set the month, day, hours and minutes in the same way.

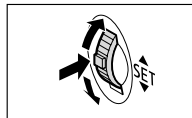

7. Press the MENU button to close the menu and to start the clock.

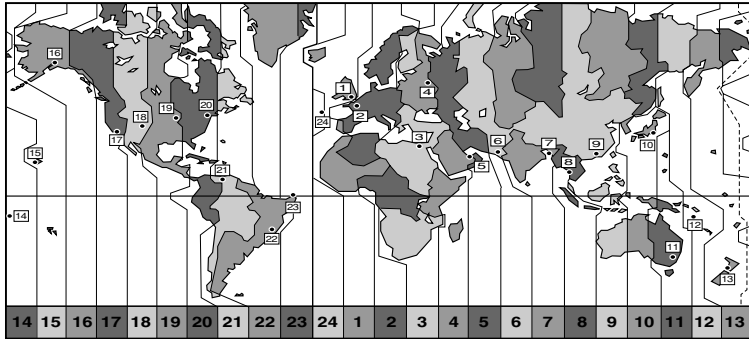
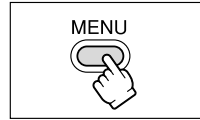

No.	Time zone	No.	Time zone
1	LONDON	13	WELLGTON (Wellington)
2	PARIS	14	SAMOA
3	CAIRO	15	HONOLU. (Honolulu)
4	MOSCOW	16	ANCHOR. (Anchorage)
5	DUBAI	17	L.A. (Los Angeles)
6	KARACHI	18	DENVER
7	DACCA	19	CHICAGO
8	BANGKOK	20	N.Y. (New York)
9	H. KONG (Hong Kong)	21	CARACAS
10	TOKYO	22	RIO (Rio de Janeiro)
11	SYDNEY	23	FERNAN. (Fernando de Noronha)
12	SOLOMON	24	AZORES



Once you have set time zone, date and time, you do not need to reset the clock each time you travel to another time zone. Just set the time zone to the one of your destination, and the camcorder automatically adjusts the clock.

Displaying Date and Time during Recording

You can display the date and time in the lower left corner of the screen.

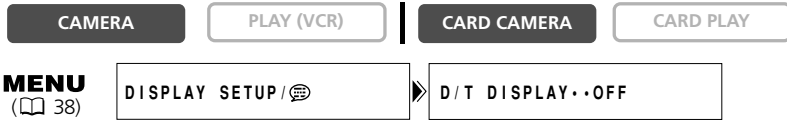

E

1. Press the MENU button to open the menu.

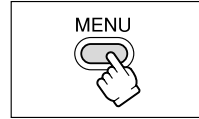

2. Turn the SET dial to select [DISPLAY SETUP/🌐] and press the SET dial.
3. Turn the SET dial to select [D/T DISPLAY] and press the SET dial.
4. Turn the SET dial to select [ON].
5. Press the MENU button to close the menu.

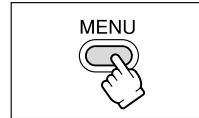
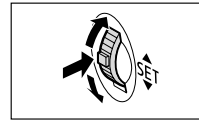

Basic Functions -
Preparations

Recording Movies on a Tape

Before You Begin Recording

Make a test recording first to check if the camcorder operates correctly. Before you make important recordings, clean the video heads (📖 143).

Recording

1. Remove the lens cap.

2. Set the camcorder to CAMERA mode.

Set the POWER switch to CAMERA and the TAPE/CARD switch to 📀.

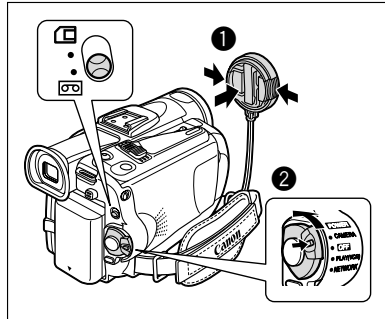

3. Push the OPEN button at the LCD panel and open the LCD panel.

4. Press the start/stop button to begin recording.

Press the start/stop button again to pause recording.

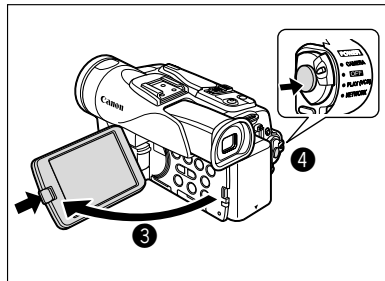

When You Have Finished Recording

1. Turn the POWER switch to OFF.

2. Close the LCD panel and return the viewfinder into its initial position.

3. Replace the lens cap.

4. Unload the cassette.

5. Disconnect the power source.



- Wait until the tape counter stops completely before you start recording.
- When you do not remove the cassette, you can record the next scene without producing any noise or blank sections between the recordings even if you turn the camcorder off.
- Bright light may make it difficult to use the LCD screen. In such case, use the viewfinder instead.

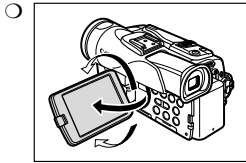

You can rotate the LCD panel. Make sure to open the LCD panel at 90 degrees before rotating it.

- When recording near loud sounds (such as fireworks, drums or concerts), sound may become distorted or may be recorded not in the actual sound level.
- **The camcorder will shut off after 5 minutes when left in record pause mode to protect tape and video heads. "⚠️ AUTO POWER OFF" appears 20 seconds before shutoff. To continue recording, turn the POWER switch to OFF and then back to CAMERA.**
- **About the LCD and viewfinder screen: The screens are produced with extremely high-precision manufacturing techniques, with more than 99.99% of the pixels operating to specification. Less than 0.01% of the pixels may occasionally misfire or appear as black or green dots. This has no effect on the recorded image and does not constitute a malfunction.**

Allowing the Subject to Monitor the LCD Screen

You can rotate the LCD panel so that the screen faces in the same direction as the lens. The viewfinder switches on allowing you to use the viewfinder while the subject can monitor the screen.

The image appears mirror reversed (LCD MIRROR ON). However, you can choose to display the image as it is being recorded (LCD MIRROR OFF).

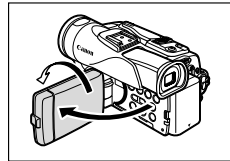

MENU
(38)



1. Press the MENU button to open the menu.

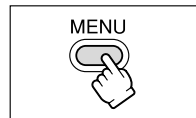

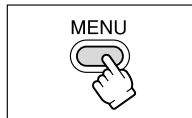
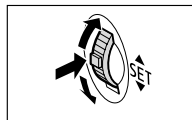

2. Turn the SET dial to select [DISPLAY SETUP/ ] and press the SET dial.
3. Turn the SET dial to select [LCD MIRROR] and press the SET dial.
4. Turn the SET dial to select [OFF].
5. Press the MENU button to close the menu.

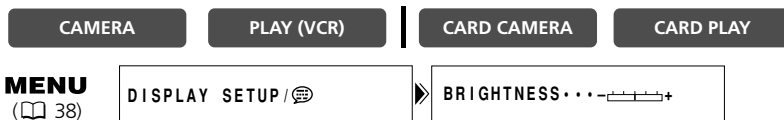

When [LCD MIRROR] is set to [ON], only tape or card operation and self-timer displays appear on the LCD screen (all displays appear on the viewfinder screen).

Adjusting the Brightness of the LCD Screen



1. Press the MENU button to open the menu.
2. Turn the SET dial to select [DISPLAY SETUP/ ] and press the SET dial.
3. Turn the SET dial to select [BRIGHTNESS] and press the SET dial.
4. Turn the SET dial to adjust the brightness level.
5. Press the MENU button to close the menu.

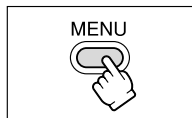
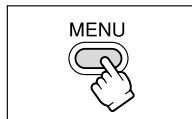

Changing the brightness of the LCD screen does not affect that of the viewfinder or the recordings.

Screen Displays during Recording



① Time code

Indicates the recording time in hours, minutes and seconds.

② Remaining tape

Indicates the remaining time of the tape in minutes. END flashes when the tape reaches the end.

- When the time left is less than 15 seconds, the remaining tape time may not appear.
- Depending on the type of the tape, the indication may not be displayed correctly.

③ Remaining battery charge

The battery symbol indicates the charge status of the battery pack.



- The battery symbol starts flashing in red when the battery pack is empty.
- When you attach an empty battery pack, the power may turn off without displaying the battery symbol.
- The actual battery charge may not be indicated accurately depending on the condition under which battery pack and camcorder are used.

④ When the battery symbol flashes

The battery symbol flashes in red when the lithium button battery is not installed, or when it runs out.

⑤ Recording reminder

The camcorder counts from 1 to 10 seconds when you start recording. This is helpful to avoid scenes that are too short.

E

Reviewing and Searching when Recording

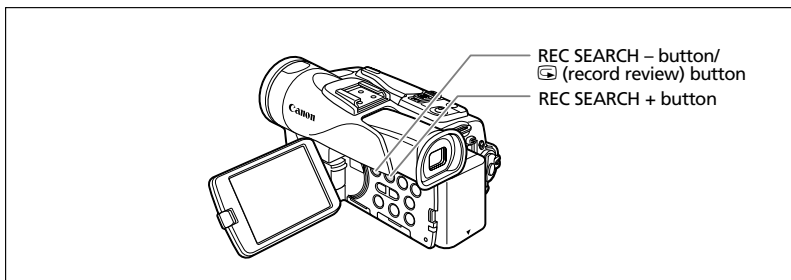

Record Review



In record pause mode, this function allows you to review the last few seconds of your recording to check if it has been recorded properly.

Press and release the (record review) button.

The camcorder rewinds the tape, plays back the last few seconds, and returns to record pause mode.

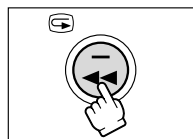

Record Search



In record pause mode, this function allows you to play back the tape (forward or reverse) to locate the point where you wish to begin recording.

Press and hold the REC SEARCH + button (forward) or - button (reverse).

- Release the button at the point you wish to begin recording.
- The camcorder returns to record pause mode.



Zooming

The camcorder automatically switches between optical zooming and digital zooming. Image resolution is slightly lower with the digital zoom.

E

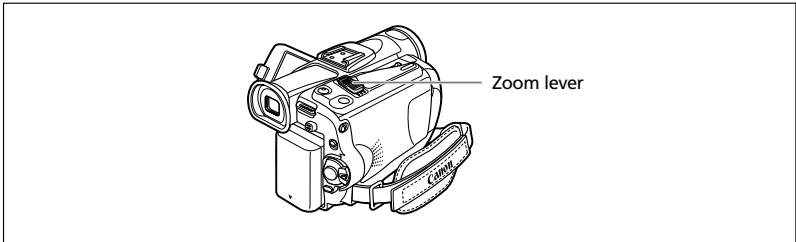
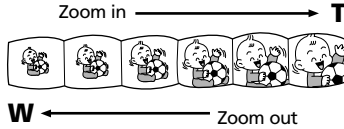

Basic Functions -
Recording

Optical Zoom

ELURA 70	ELURA 65	ELURA 60	
18× optical zoom	16× optical zoom	14× optical zoom	
CAMERA	PLAY (VCR)	CARD CAMERA	CARD PLAY

Move the zoom lever toward **W** to zoom out (wide-angle). Move it toward **T** to zoom in (telephoto).

Press the zoom lever slightly for a slow zoom. Press harder for a faster zoom.

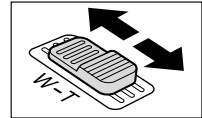

You can also use the **T** and **W** buttons on the wireless controller. However, you cannot control the zoom speed.

Digital Zoom

ELURA 70	ELURA 65	ELURA 60
72×/360× digital zoom (72× in CARD CAMERA mode)	64×/320× digital zoom (64× in CARD CAMERA mode)	56×/280× digital zoom (56× in CARD CAMERA mode)



1. Press the **MENU** button to open the menu.

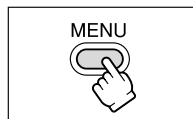

2. Turn the **SET** dial to select [**CAMERA SETUP**] and press the **SET** dial.

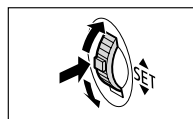

3. Turn the **SET** dial to select [**D.ZOOM**] and press the **SET** dial.

4. Turn the **SET** dial to select a setting option.

5. Press the **MENU** button to close the menu.

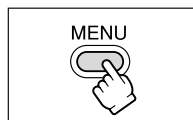

- Digital zoom cannot be used in the night modes.
- Digital zoom cannot be used when the multi-image screen is selected.
- A zoom indicator appears for 4 seconds. It extends in light blue when the digital zoom is set to 72× (ELURA70), 64× (ELURA65) or 56× (ELURA60), and extends further in dark blue when set to 360× (ELURA70), 320× (ELURA65) or 280× (ELURA60).
- Keep at least 3.3 ft. (1 m) to the subject. At wide-angle, you can focus on a subject as close as 0.39 in. (1 cm).

Tips for Making Better Videos

Holding the Camcorder

For maximum stability, grip the camcorder in your right hand and keep your right elbow pressed against your body. If necessary, support the camcorder with your left hand. Be careful that your fingers do not touch the microphone or lens.



E

For More Stability

Lean against a wall



Put the camcorder on a table

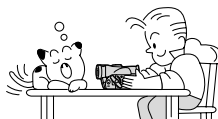

Lie on your elbow



Use a tripod



Lighting

When recording outdoors, we recommend recording with the sun at your back.

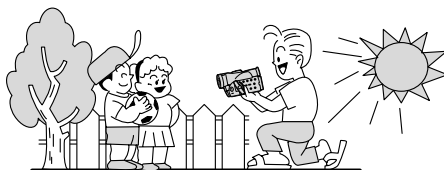

- When using a tripod, do not leave the viewfinder exposed to direct sunlight as it may melt (due to concentration of the light by the lens).
- Do not use tripods with fastening screws longer than 0.2 inch (5.5 mm) as it may damage the camcorder.

Playing Back a Tape

If the playback picture is distorted, clean the video heads using a Canon Head Cleaning Cassette or a commercially available digital video head-cleaning cassette (143).

1. Set the camcorder to PLAY (VCR) mode.

Set the POWER switch to PLAY (VCR) and the TAPE/CARD switch to .

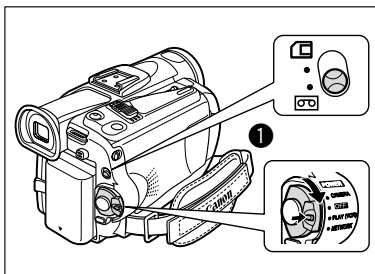

2. Open the LCD panel.

You can also close the LCD panel with the screen facing outward.

3. Press the button to rewind the tape.

4. Press the button to begin playback.

5. Press the button to stop playback.

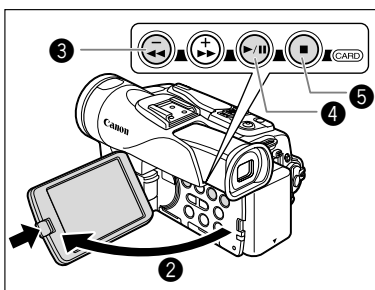

○ To use the viewfinder, close the LCD panel.

○ About the screen display: During playback, the time code gives the hours, minutes, seconds and frames. The remaining tape time may not appear when the time left is less than 15 seconds.

Special Playback Modes

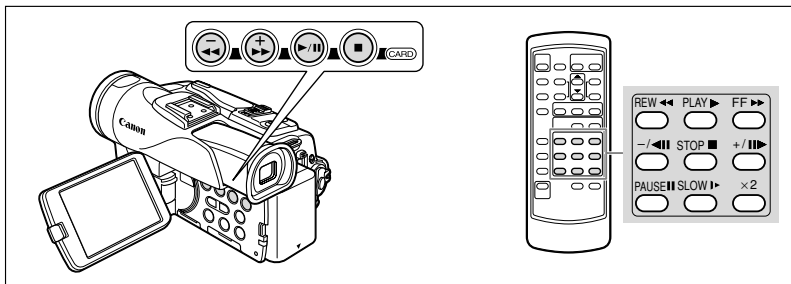

E

▶/|| (Playback Pause)

To pause playback, press the ▶/|| button during normal playback.

▶▶ (Fast Forward Playback) / ◀◀ (Rewind Playback)

Plays back the tape at 9.5 times normal speed (forward or reverse). Press and hold the button during normal playback or fast forward.

-/◀|| (Reverse Playback)

Press the button on the wireless controller during normal playback. Press the ▶ (play) button to return to normal playback.

+/||▶ (Frame Advance) / -/◀|| (Frame Reverse)

Plays back frame-by-frame. Press the button on the wireless controller repeatedly during playback pause. Press and hold it to play back continuous frame advance/frame reverse.

SLOW ▶▶ (Slow Forward)/(Slow Reverse)

Plays back at about 1/3 normal speed. Press the button on the wireless controller during normal or reverse playback. Press the ▶ (play) button to return to normal playback.

× 2 (Forward ×2 Playback)/(Reverse ×2 Playback)

Plays back at 2 times normal speed. Press the button on the wireless controller during normal or reverse playback. Press the ▶ (play) button to return to normal playback.



- There is no sound during special playback.
- The picture may become distorted during some special playback modes.
- The camcorder stops the tape automatically after 5 minutes in playback pause mode to protect tape and video heads.

Adjusting the Volume

When you use the LCD screen for playback, the camcorder plays back the sound via built-in speaker. The built-in speaker does not sound when you close the LCD panel. Use headphones when using the viewfinder.

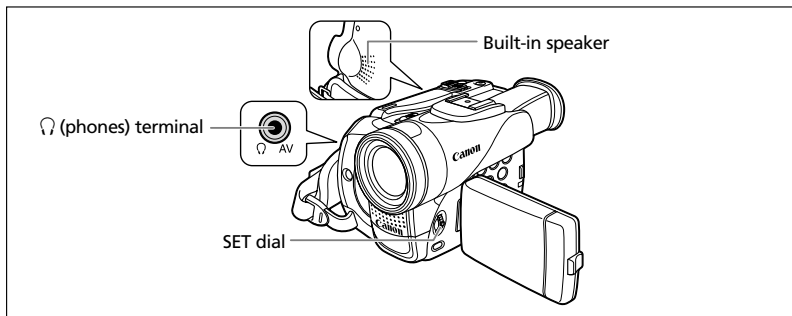

When Using Headphones

The headphones terminal also serves as AV terminal. Headphones can only be used when "Ω" is displayed on the screen. If not, change the setting following the procedure below.



Open the menu and select [VCR SETUP]. Select [AV/PHONES Ω], set it to [PHONES Ω] and close the menu.



- The built-in speaker does not sound when "Ω" is displayed.
- Do not connect headphones unless "Ω" is displayed as it produces noise.

Adjusting the Volume



Turn the SET dial up to increase the volume, and down to lower the volume.

- A volume bar appears for 2 seconds.
- You can turn off the volume completely by turning the SET dial down until [OFF] appears. Turn the SET dial up to increase the volume again.

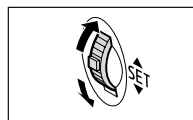

Playing Back on a TV Screen

The AV terminal also serves as headphones terminal. When "Ω" is displayed on the screen, change the setting following the procedure below.

E



MENU
(38)

VCR SETUP

AV / PHONES Ω ·· AV

Open the menu and select [VCR SETUP]. Select [AV/PHONES Ω], set it to [AV] and close the menu.

TVs with Audio/Video Terminals

Refer also to the TV or VCR instruction manual.

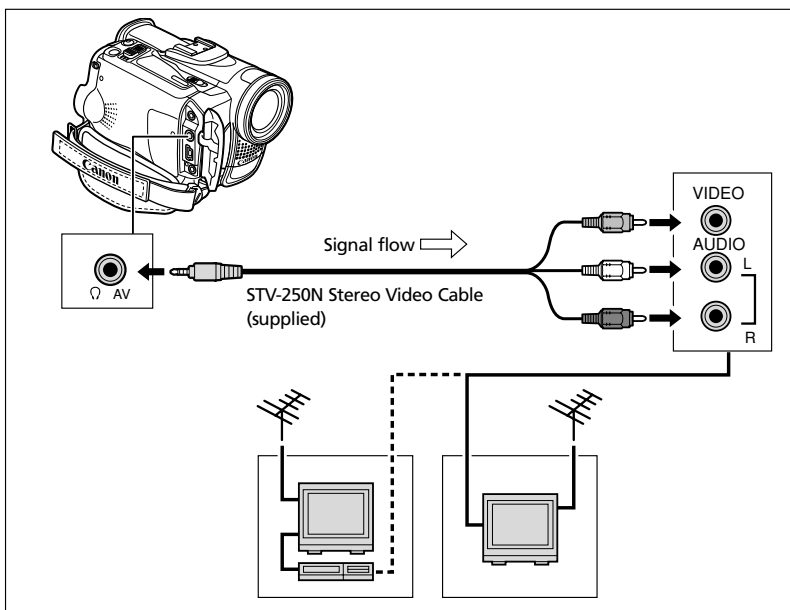

Basic Functions -
Playback

1. Turn off all devices before starting the connections.
2. Connect the STV-250N Stereo Video Cable to the camcorder's AV terminal and the audio/video terminals on the TV/VCR.
Connect the white plug to the white audio terminal L (left), the red plug to the red audio terminal R (right) and the yellow plug to the yellow video terminal VIDEO.
3. If connecting to a TV, set the input selector to VIDEO. If connecting to a VCR, set the input selector to LINE.

TVs with S (S1)-Video Input Terminal

Refer also to the TV or VCR instruction manual.

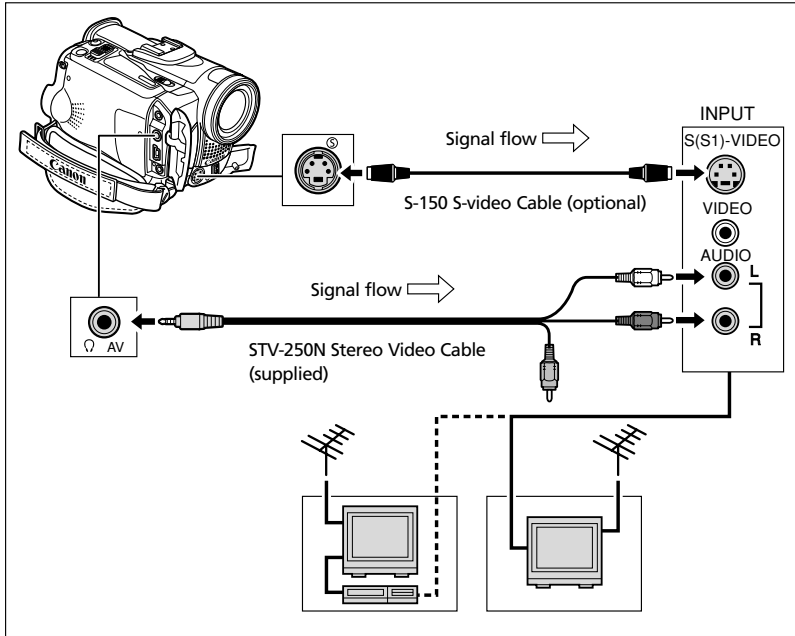

1. Turn off all devices before starting the connections.
2. Connect the S-150 S-video Cable (optional) to the S-video terminals.
3. Connect the STV-250N Stereo Video Cable to the camcorder's AV terminal and the audio terminals of the TV/VCR.
Connect the white plug to the white AUDIO terminal L (left), and the red plug to the red AUDIO terminal R (right). Do not connect the yellow plug.
4. If connecting to a TV, set the input selector to VIDEO. If connecting to a VCR, set the input selector to LINE.



- We recommend powering the camcorder from a household power source.
- The picture quality is higher when connecting to a TV with an S (S1) terminal.
- TVs with S1-terminal or Video ID-1 system: Recordings made in the 16:9 mode will be automatically played back in widescreen mode.

Selecting the Audio Output Channel

You can select the output channels when playing back a tape with audio recorded on two channels.



E

1. Press the **MENU** button to open the menu.

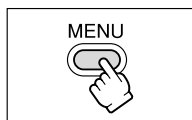

2. Turn the **SET** dial to select **[AUDIO SETUP]** and press the **SET** dial.

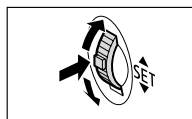

3. Turn the **SET** dial to select **[OUTPUT CH]** and press the **SET** dial.

4. Turn the **SET** dial to select a setting option.

- L/R: Stereo: L+R channels, Bilingual: Main+Sub.
- L/L: Stereo: L channel, Bilingual: Main.
- R/R: Stereo: R channel, Bilingual: Sub.

5. Press the **MENU** button to close the menu.

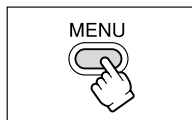

The setting resets to the L/R setting when you turn the camcorder off.

Menus and Settings

Many of the camcorder's advanced functions are selected from menus that appear on the screen.

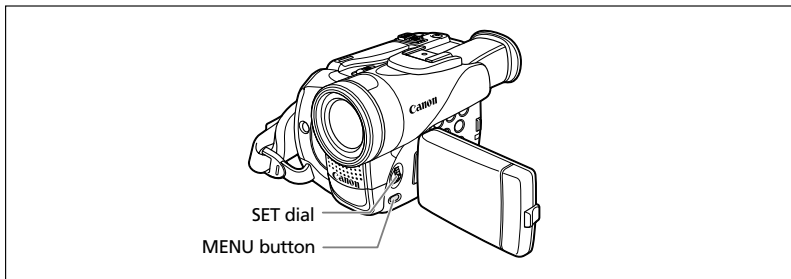

Selecting Menus and Settings

1. Press the MENU button to open the menu.

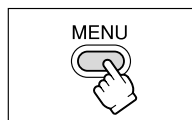

2. Turn the SET dial to select a submenu and press the SET dial.

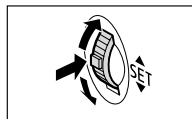

3. Turn the SET dial to select a menu item and press the SET dial.

4. Turn the SET dial to select a setting option.

5. Press the MENU button to close the menu.

When setting the white balance, shutter speed or language, press the SET dial first before pressing the MENU button.

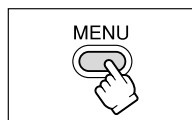

- Pressing the MENU button at any time closes the menu.
- Items that are not available appear in purple.
- You may find it more convenient to use the wireless controller to operate the menu. Press the MENU button on the wireless controller to open or close the menu. Use the select buttons in place of the SET dial and press the SET button in place of pressing the SET dial.

Menu and Default Settings

Default settings are shown in boldface.

CAMERA MENU



E

Submenu	Menu Item	Setting Options		
→CARD MIX	MIX TYPE	CARD CHROMA , CARD LUMI., CAM. CHROMA, C. ANIMATION	113	
	ANIMAT. TYPE	CORNER , STRAIGHT, RANDOM		
	MIX LEVEL			
CAMERA SETUP	SHUTTER	AUTO , 1/60, 1/100, 1/250, 1/500, 1/1000, 1/2000	56	
	A.SL SHUTTER	ON , OFF	57	
	D. ZOOM	ELURA70	ELURA65	ELURA60
		OFF, 72×, 360×	OFF, 64×, 320×	OFF, 56×, 280×
	IMG STAB (📷)	ON , OFF	79	
	16:9	ON , OFF	78	
	WHITE BAL.	AUTO , SET 📷, INDOOR 🏠, OUTDOOR 🌳	54	
	(FLASH*)	AUTO ⚡, RED-EYE 📷, FLASH ON ⚡, FLASH OFF 📷	80	
	(AF AST LAMP*)	AUTO , OFF	81	
	NIGHT MODE*	📷NIGHT, 📷NIGHT+, 📷S.NIGHT	48	
	SKIN DETAIL	SOFT, NORMAL	50	
STILL I. REC	OFF , 📷FINE, 📷NORMAL	97		
VCR SETUP	REC MODE	SP , LP	59	
	AV/PHONES 📞	AV , PHONES 📞	61	
AUDIO SETUP	WIND SCREEN	AUTO , OFF	60	
	AUDIO MODE	16bit, 12bit	60	
	📞 VOLUME		61	
DISPLAY SETUP/ 📷	BRIGHTNESS		26	
	LCD MIRROR	ON , OFF	25	
	TV SCREEN	ON , OFF	136	
	D/T DISPLAY	ON , OFF	23	
	LANGUAGE 🗣️	DEUTSCH, ENGLISH , ESPAÑOL, FRANÇAIS, ITALIANO, РУССКИЙ, 中文, 日本語	76	
	DATE FORMAT		76	
	DEMO MODE	ON , OFF	79	

* ELURA70/ELURA65 only.

(): Appears when you attach the optional VFL-1 Video Flash Light and set it to 📷 ON.

Submenu	Menu Item	Setting Options	
SYSTEM	WL. REMOTE	Ⓜ1, Ⓜ2, OFF Ⓜ	77
	BEEP	ON, OFF	78
	T.ZONE/DST	See list of time zones.	21
	D/TIME SET		21
MY CAMERA	S-UP SOUND	OFF, DEFAULT, MY SOUND	75
	SHTR SOUND		
	OPER. SOUND		
	SELF-T SOUND		

PLAY (VCR) MENU





















Submenu	Menu Item	Setting Options	
VCR SETUP	REC MODE	SP, LP	59
	AV/PHONES	AV, PHONES	34
	AV → DV OUT	ON, OFF	87
AUDIO SETUP	OUTPUT CH	L/R, L/L, R/R	37
	AUDIO DUB.	AUDIO IN, MIC. IN	89
	WIND SCREEN	AUTO, OFF	60
	AUDIO MODE	16bit, 12bit	60
	12bit AUDIO	STEREO1, STEREO2, MIX/FIXED, MIX/VARI.	90
	MIX BALANCE		90
	CARD SETUP	IMG QUALITY	SUPER FINE, FINE, NORMAL
	MOVIE SIZE	320 × 240, 160 × 120	94
	FILE NOS.	RESET, CONTINUOUS	95
DISPLAY SETUP/ 	BRIGHTNESS		26
	TV SCREEN	ON, OFF	136
	DISPLAYS	ON, OFF <PLAYBK>	136
	6SEC. DATE	ON, OFF	71
	DATA CODE	DATE/TIME, CAMERA DATA, CAM. & D/T	70
	D/TIME SEL.	DATE, TIME, DATE & TIME	70
	LANGUAGE	DEUTSCH, ENGLISH, ESPAÑOL, FRANÇAIS, ITALIANO, РУССКИЙ, 中文, 日本語	76
	DATE FORMAT		76
SYSTEM	WL. REMOTE	1, 2, OFF	77
	BEEP	ON, OFF	78
	T.ZONE/DST	See list of time zones.	21
	D/TIME SET		21
MY CAMERA	S-UP SOUND	OFF, DEFAULT, MY SOUND	75
	SHTR SOUND		
	OPER. SOUND		
	SELF-T SOUND		

E

Advanced Functions

CARD CAMERA MENU

CAMERA	PLAY (VCR)	CARD CAMERA	CARD PLAY
--------	------------	--------------------	-----------

Submenu	Menu Item	Setting Options		
CAMERA SETUP	SHUTTER	AUTO, 1/60, 1/100, 1/250	56	
	A.SL SHUTTER	ON, OFF	57	
	D. ZOOM	ELURA70	ELURA65	30
		OFF, 72×	OFF, 64×	OFF, 56×
	WHITE BAL.	AUTO, SET  , INDOOR  , OUTDOOR 	54	
	(FLASH*)	AUTO  , RED-EYE  , FLASH ON  , FLASH OFF 	80	
	(AF AST LAMP*)	AUTO, OFF	81	
	FOCUS PRI.	ON, OFF	103	
	ND	AUTO, OFF	97	
	NIGHT MODE*	 NIGHT,  NIGHT+,  S.NIGHT	48	
	SKIN DETAIL	SOFT, NORMAL	50	
REVIEW	OFF, 2sec, 4sec, 6sec, 8sec, 10sec	100		
CARD SETUP	IMG QUALITY	SUPER FINE, FINE, NORMAL	93	
	IMAGE SIZE	1280 × 960, 640 × 480	93	
	MOVIE SIZE	320 × 240, 160 × 120	94	
	FILE NOS.	RESET, CONTINUOUS	95	
VCR SETUP	AV/PHONES 	AV, PHONES 	61	
AUDIO SETUP	WIND SCREEN	AUTO, OFF	60	
	 VOLUME		61	
DISPLAY SETUP/ 	BRIGHTNESS		26	
	LCD MIRROR	ON, OFF	25	
	TV SCREEN	ON, OFF	136	
	D/T DISPLAY	ON, OFF	23	
	LANGUAGE 	DEUTSCH, ENGLISH, ESPAÑOL, FRANÇAIS, ITALIANO, РУССКИЙ, 中文, 日本語	76	
	DATE FORMAT		76	
	DEMO MODE	ON, OFF	79	
SYSTEM	WL. REMOTE	 1,  2, OFF 	77	
	BEEP	ON, OFF	78	
	T.ZONE/DST	See list of time zones.	21	
	D/TIME SET		21	

* ELURA70/ELURA65 only.

(): Appears when you attach the optional VFL-1 Video Flash Light and set it to  ON.

Submenu	Menu Item	Setting Options	
MY CAMERA	S-UP SOUND	OFF, DEFAULT, MY SOUND	75
	SHTR SOUND		
	OPER. SOUND		
	SELF-T SOUND		



CARD PLAY MENU



Submenu	Menu Item	Setting Options	
CARD OPERATIONS (Single Image Display)	PRINT ORDERS ALL ERASE	NO, YES	129
	TRANS. ORDERS ALL ERASE	NO, YES	134
	IMAGE ERASE	CANCEL, SINGLE, ALL	112
	FORMAT	CANCEL, EXECUTE	117
CARD OPERATIONS (Index Screen)	PROTECT		111
	PRINT ORDER		128
	TRANSFER ORDER		134
VCR SETUP	AV/PHONES	AV, PHONES	34
DISPLAY SETUP/ 	BRIGHTNESS		26
	TV SCREEN	ON, OFF	136
	DISPLAYS	ON, OFF <PLAYBK>	136
	D/TIME SEL.	DATE, TIME, DATE & TIME	70
	LANGUAGE	DEUTSCH, ENGLISH, ESPANOL, FRANÇAIS, ITALIANO, РУССКИЙ, 中文, 日本語	76
	DATE FORMAT		76
SYSTEM	WL. REMOTE	1, 2, OFF	77
	BEEP	ON, OFF	78
	T.ZONE/DST	See list of time zones.	21
	D/TIME SET		21
MY CAMERA	CREATE START-UP IMAGE		118
	SEL. S-UP IMG	NO IMAGE, CANON LOGO, MY IMAGE	75
	S-UP SOUND	OFF, DEFAULT, MY SOUND	75
	SHTR SOUND		
	OPER. SOUND		
	SELF-T SOUND		
PRINT	Appears when connecting a printer with direct print function.		129

Using the Recording Programs

Easy Recording Program

The camcorder adjusts focus, exposure and other settings automatically, allowing you to just point and shoot.



E

Program AE Modes

Auto

The camcorder adjusts focus, exposure and other settings automatically. However, you have the option of adjusting the settings manually.



Sports

Use this mode to record sports scenes (such as tennis or golf) or moving objects (such as roller coasters).



Portrait

Use this mode to give accent to your subject by blurring the background or foreground. The blur effect increases the more you zoom to telephoto.



Spotlight

Use this mode to record spotlight scenes or fireworks.



Sand & Snow

Use this mode in bright places such as a sunny beach or ski resort. It prevents the subject from being underexposed.



Low Light

Use this mode to record in dimly lit places.



Advanced Functions -
Recording

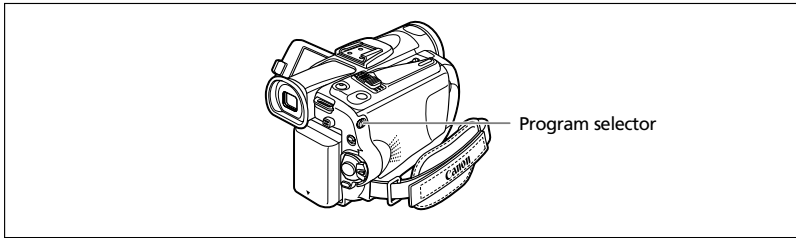

Availability of Functions in Each Mode:

Recording Program							
Digital Zoom	<input type="radio"/>						<input type="radio"/>
Image Stabilizer	ON						<input type="radio"/>
Focus	A						<input type="radio"/>
White Balance	A						<input type="radio"/>
Shutter Speed	A	<input type="radio"/>					A
Exposure Lock	×						<input type="radio"/>
Digital Effects	×						<input type="radio"/>
16:9	×						<input type="radio"/>
Card Mix	×						<input type="radio"/>

A: Auto setting : Available : Not available
Shaded area: Can be used only in CAMERA mode.

Selecting the Easy Recording Program



Set the program selector to .

“” appears.

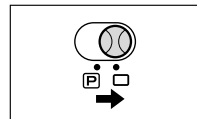

Selecting the Program AE Mode

CAMERA

PLAY (VCR)

CARD CAMERA

CARD PLAY

E

1. Set the program selector to **P**.

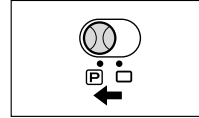

2. Press the SET dial.

A list of the program AE modes appears.

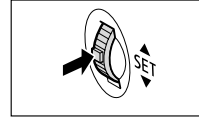

3. Select a mode and press the SET dial.

The symbol of the mode appears on the upper left corner of the screen.



- The setting resets to the Auto mode when you change the position of the program selector.
- Do not change the mode during recording as the brightness of the image may change abruptly.
- Sports/Portrait mode:
 - The picture may not appear smooth when played back.
- Sand & Snow mode:
 - The subject may become overexposed in dark surroundings. Check the image on the screen.
 - The picture may not appear smooth when played back.
- Low Light mode:
 - Moving subjects may leave a trailing afterimage.
 - Picture quality may not be as good as in other modes.
 - The camcorder may have difficulty to focus automatically.

Using the Night Modes

NIGHT	Allows you to record in dark places where lights cannot be used, without sacrificing color.
ELURA 70/ELURA 65 NIGHT+	The assist lamp (white LED) lights up and stays on.
ELURA 70/ELURA 65 SUPER NIGHT	Allows you to record in very dark places. The assist lamp (white LED) lights up automatically responding to the surrounding brightness.



Night Mode



Night+ Mode
Super Night Mode

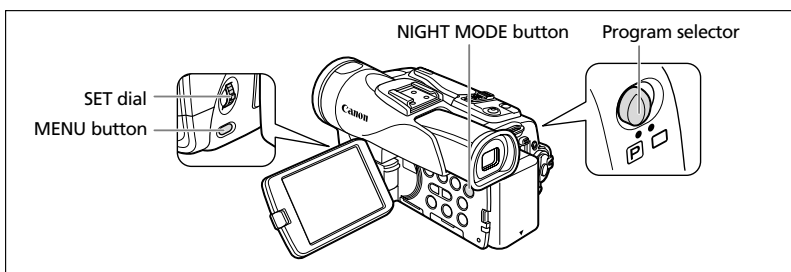

CAMERA

PLAY (VCR)

CARD CAMERA

CARD PLAY

ELURA 70/ELURA 65

MENU



(38)

CAMERA SETUP

NIGHT MODE...  NIGHT+

1. Set the program selector to .
2. Open the menu and select [CAMERA SETUP]. Select [NIGHT MODE], select a setting option and close the menu.
3. Press the NIGHT MODE button.
 - The symbol of the selected mode appears on the screen.
 - Pressing the NIGHT MODE button again resets the camcorder to the Auto mode.

ELURA 60

1. Set the program selector to .
2. Press the NIGHT MODE button.
 - "" appears.
 - Pressing the NIGHT MODE button again resets the camcorder to the Auto mode.



- Moving subjects may leave a trailing afterimage.
- Picture quality may not be as good as in other modes.
- White points may appear on the screen.
- Autofocus may not work as well as in other modes. In such case, adjust the focus manually.
- Digital zoom and multi-image screen cannot be used while a night mode is activated.
- The program AE mode cannot be changed while a night mode is activated.



Skin Detail Function

When shooting close-ups of people, the camcorder automatically softens details to reduce the appearance of skin imperfections for a more complimentary appearance.

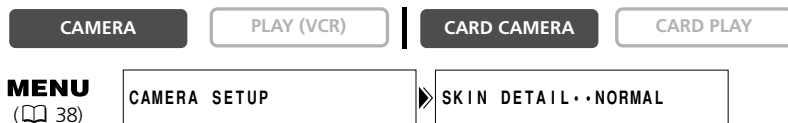

Open the menu and select [CAMERA SETUP]. Select [SKIN DETAIL], set it to [SOFT] and close the menu.



- Skin detail function cannot be used when the program selector is set to .
- To obtain the best effect, use this function when recording a person in close-up. Note that areas similar to the skin color may lack in detail.

Adjusting Exposure Manually

E

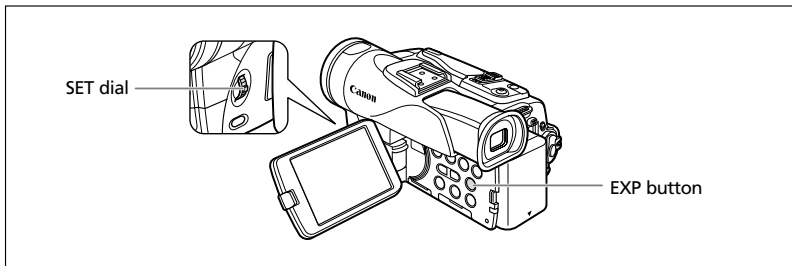

Exposure Lock

You can lock the exposure when recording in situations where the lighting may change suddenly to control the brightness of the image.



1. Set the program selector to .

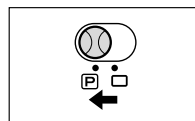

2. Press the EXP button.

- "E.LOCK ±0" appears on the screen.
- When you operate the zoom during exposure lock, the brightness of the image may change.

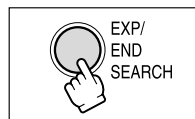

Advanced Functions -
Recording

Exposure Adjustment

When the exposure is locked, you can adjust it manually to handle difficult lighting conditions. The camcorder's iris can be set to any position from fully closed to fully open.



Turn the SET dial to adjust the brightness of the image.

The adjustment range depends on the brightness at the time you locked the exposure.

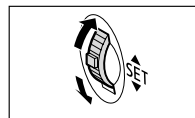

Adjusting the Focus Manually

Autofocus may not work well on the following subjects. In such case, focus manually.

Reflective surfaces



Subjects with low contrast or without vertical lines

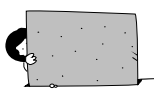

Fast Moving Subjects

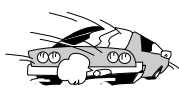

Through dirty or wet windows



Night Scenes

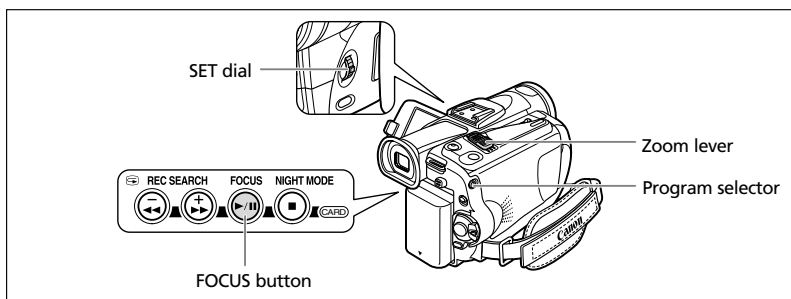

CAMERA

PLAY (VCR)

CARD CAMERA

CARD PLAY

1. Set the program selector to .

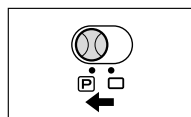

2. Adjust the zoom.

When you operate the zoom after adjusting the focus, the subject may not stay in focus. Adjust the zoom before the focus.

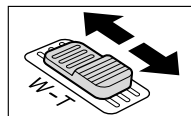

3. Press the FOCUS button.

"MF" appears.



4. Turn the SET dial to adjust the focus.

- Turn the SET dial up or down until the image appears focused.
- Press the FOCUS button to return to autofocus.





- The setting resets to autofocus when you switch the program selector to □.
- Readjust the focus when you have turned off the camcorder.

Infinity Focus

E

Use this function when you wish to focus on faraway subjects such as mountains or fireworks.

Press the FOCUS button more than 2 seconds after step 2 in *Adjusting the Focus Manually*.



"MF ∞" appears.





When you operate the zoom or turn the SET dial, "∞" disappears and the camcorder changes to manual focus.

Setting the White Balance

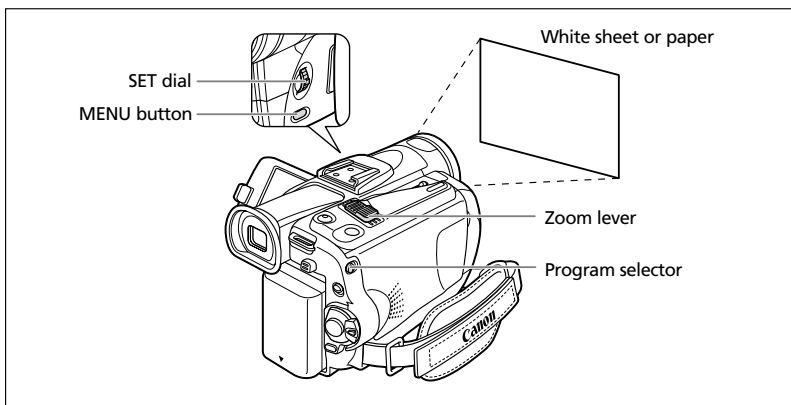

You can use the preset modes to reproduce colors more accurately, or set a custom white balance to obtain the optimal setting.

AUTO	Auto white balance
SET 	Custom white balance setting
INDOOR 	Use this mode for recording under changing lighting condition, video lights or sodium lamps.
OUTDOOR 	Use this mode for recording night scenes, fireworks, sunrise or sunset.



1. Set the program selector to .
2. For custom white balance: Point the camcorder at a white object and zoom in until it fills the whole screen.
3. Open the menu and select [CAMERA SETUP]. Select [WHITE BAL.], select a setting option and close the menu.

Keep the camcorder zoomed at the white object until step 3 is completed.

When you have selected [SET ]: "  " flashes and stops flashing when settings is complete.



- Use the auto setting for normal outdoor scenes.
- When the program selector is set to , white balance is preset to [AUTO].
- The camcorder retains the custom white balance setting even if you turn it off. However, it resets to [AUTO] when you change the position of the TAPE/CARD switch.
- When you have set the custom white balance:
 - Depending on the light source, “” may keep flashing. The result will still be better than with the auto setting.
 - Reset the white balance when the lighting condition changes.
 - Turn off the digital zoom.
- Custom white balance may provide better results in the following cases:
 - Changing lighting conditions
 - Close-ups
 - Subjects in a single color (sky, sea or forest)
 - Under mercury lamps or certain types of fluorescent lights



Setting the Shutter Speed

You can adjust the shutter speed manually to make stable shots of fast moving subjects.



1. Set the program selector to **P**.
2. Set the program AE mode to the **A** (Auto) mode.
3. Open the menu and select [CAMERA SETUP].
4. Select [SHUTTER].
5. Select the shutter speed and press the SET dial.

CAMERA Mode	CARD CAMERA Mode
AUTO	AUTO
1/60	1/60
1/100	1/100
1/250	1/250
1/500	
1/1000	
1/2000	

6. Close the menu.



- If the shutter speed is set to 1/500 or higher in CAMERA mode and you switch to CARD CAMERA mode, it automatically changes to 1/250.
- Do not point the camcorder directly at the sun when the shutter speed is set to 1/1000 or higher.
- The image may flicker when recording with high shutter speeds.
- Recording under fluorescent lights (CAMERA mode): In Easy Recording, Auto mode or the night modes, the camcorder automatically detects the flicker of fluorescent lighting and adjusts the shutter speed accordingly. However, if the screen starts to flicker, select AUTO mode and set the shutter speed to 1/100.
- The setting resets to the auto setting when you switch the program selector to **P**, or change the program AE mode.
- Guidelines for Recording with High Shutter Speeds:
 - Outdoor sports such as golf or tennis: 1/2000
 - Moving objects such as cars or roller coasters: 1/1000, 1/500 or 1/250
 - Indoor sports such as basketball: 1/100

Auto Slow Shutter

In Easy Recording mode and when [SHUTTER] is set to [AUTO] in Auto mode, the camcorder uses shutter speeds down to 1/30 in CAMERA mode and 1/15 in CARD CAMERA mode. This allows you to record brightly in places with insufficient lighting. However, you can set the camcorder not to use a slow shutter speed.

E

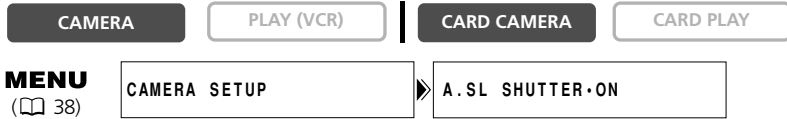

Open the menu and select [CAMERA SETUP]. Select [A.SL SHUTTER], set it to [OFF] and close the menu.



- When set to [ON], moving subjects may leave a trailing afterimage.
- If “” (camcorder shake warning) appears in CARD CAMERA mode, stabilize the camcorder, for example, by mounting it on a tripod or placing it on a table.

Using the Self-Timer

The self-timer can be used for recording movies and still images.

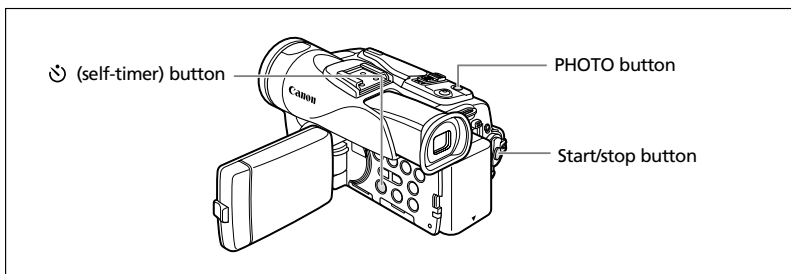

CAMERA

PLAY (VCR)

CARD CAMERA

CARD PLAY

When recording movies

1. Press the (self-timer) button.

" (self-timer) " appears.

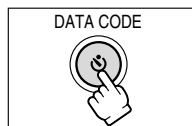

2. Press the start/stop button.

- The camcorder starts recording after a 10-second countdown (2 seconds when using the wireless controller). The count down appears on the screen.
- To record a still image, press the PHOTO button (96).



- To cancel the self-timer, press the (self-timer) button. Once the countdown has begun, you can also press the start/stop button (when recording movies) or the PHOTO button (when recording still image) to cancel the self-timer.
- The self-timer will be canceled when you turn off the camcorder.

Changing the Recording Mode (SP/LP)

You can choose between SP (standard play) and LP (long play). LP extends the tape usage by 1.5 times.

E



To change to LP mode, open the menu and select [VCR SETUP]. Select [REC MODE], set it to [LP] and close the menu.



- Tapes recorded in LP mode cannot be used for audio dubbing (📖 88).
- Depending on the nature and usage condition of the tape, picture and sound recorded in LP mode may be distorted. We recommend using the SP mode for important recordings.



- If you record in both SP and LP modes on the same tape, the playback picture may become distorted and the time code may not be written correctly.
- If you play back a tape that has been recorded in LP mode with another digital device on this camcorder, or vice versa, picture and sound may become distorted.

Audio Recording

Changing the Audio Mode

You can record sound in two audio modes—16-bit and 12-bit. The 12-bit mode records sound on two channels (stereo 1), leaving 2 channels free (stereo 2) for adding new sound later. Select the 16-bit mode for higher sound quality.



Open the menu and select [AUDIO SETUP]. Select [AUDIO MODE], set it to [16bit] and close the menu.

“16bit” appears for approximately 4 seconds.

Wind Screen

The camcorder reduces wind noise automatically. However, you can turn off the wind screen when recording indoors, or when you want the microphone to be as sensitive as possible.

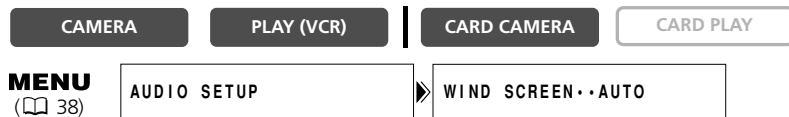

Open the menu and select [AUDIO SETUP]. Select [WIND SCREEN], set it to [OFF] and close the menu.

“WS ” appears when you turn the wind screen off.



- The wind screen function can only be used with the built-in microphone.
- The wind screen function can also be used for audio dubbing (when [AUDIO DUB.] is set to [MIC. IN] in the [AUDIO SETUP] submenu).

Using Headphones during Recording

The headphones terminal also serves as AV terminal. Headphones can only be used when "🎧" is displayed on the screen. If not, change the setting following the procedure below.



Open the menu and select [VCR SETUP]. Select [AV/PHONES 🎧], set it to [PHONES 🎧] and close the menu.

Adjusting the Headphone Volume



Open the menu and select [AUDIO SETUP]. Select [🎧 VOLUME], adjust the volume with the SET dial and close the menu.

You can turn off the volume completely by turning the SET dial down until [OFF] appears. Turn the SET dial up to increase the volume again.

ELURA 70/ELURA 65 Recording with an External Microphone

You can attach a commercially available microphone or the optional DM-50 Directional Stereo Microphone to the accessory shoe. Refer also to the instruction manual of the microphone.

1. Attach the microphone to the accessory shoe.
2. When using a commercially available microphone, connect it to the MIC terminal.

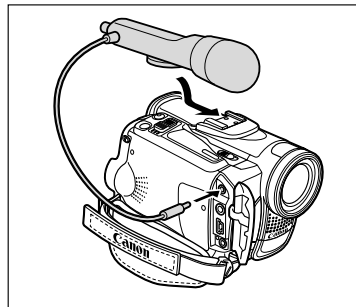







- When recording in silent places, the built-in microphone may pick up the motor noise of the camcorder. In such case, we recommend using an external microphone.
- When using a commercially available microphone:
 - Use a microphone with built-in power supply (condenser microphone). Almost all stereo microphones with a plug diameter of 0.14 in. (3.5 mm) can be connected. The audio level may differ from that of the built-in microphone.
 - Long microphones may appear on the screen.

Using Digital Effects

Faders (📖 65)





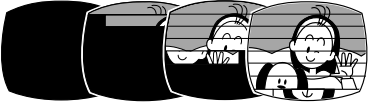
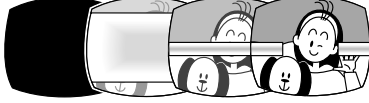
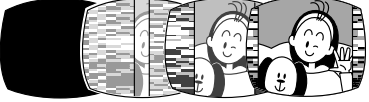

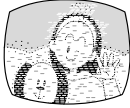

Begin or end scenes with a fade to or from black.

<p>Fade Trigger (FADE-T)</p> 	<p>The image gradually fades in.</p>
<p>Wipe (WIPE)</p> 	<p>The image gradually fades out.</p> <p>The image begins as a vertical line in the center and expands sideways until it fills the whole screen.</p>
<p>Corner Wipe (CORNER)</p> 	<p>The image is wiped off from the sides of the screen.</p> <p>The image appears from the corners until it fills the whole screen.</p>
<p>Jump (JUMP)</p> 	<p>The image is wiped off from the corners.</p> <p>A small image appears from the left, jumps into the center and enlarges until it fills the whole screen.</p>
<p>Flip (FLIP)</p> 	<p>The image shrinks, jumps from the center to the left and disappears.</p> <p>The image flips into the screen.</p> <p>The image flips out of the screen.</p>

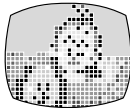
<p>Puzzle (PUZZLE)</p> 	<p>The image appears in 16 pieces. The pieces move around until the puzzle is solved.</p> <p>The image is divided into 16 pieces. The pieces move around and disappear.</p>
<p>Zigzag (ZIGZAG)</p> 	<p>The image appears in zigzag from the top of the screen.</p> <p>Black stripes appear in zigzag from the bottom of the screen until they cover the whole image.</p>
<p>Beam (BEAM)</p> 	<p>The screen turns yellow, forms a beam that becomes thinner and the image appears.</p> <p>A yellow beam appears in the center of the screen and expands until it covers the whole image.</p>
<p>Tide (TIDE)</p> 	<p>The image appears from both sides like tides.</p> <p>The image disappears from both sides like tides.</p>

Effects (66)

Add flavor to your recordings.

<p>Art (ART) The image becomes like a paint (solarization).</p> 	<p>Black and White (BLK & WHT) The image becomes black and white.</p> 	<p>Sepia (SEPIA) The image becomes monochrome with a brownish tint.</p> 
<p>Mosaic (MOSAIC) The image is blurred through enlarging the size of some pixels.</p> 	<p>Ball (BALL) The image becomes like a ball.</p> 	<p>Cube (CUBE) The image becomes a cube and rotates.</p> 
<p>Wave (WAVE) Both ends of the image sway in waves.</p> 	<p>Color Masking (COLOR M.) The image becomes a rhombus surrounded by a masking frame that changes the colors.</p> 	<p>Mirror (MIRROR) Creates a symmetrical image as if there would be a mirror in the center of the screen.</p> 

Multi-Image Screen (67)

Captures moving subjects in 4, 9 or 16 sequences of still images and displays them at one time. Sound will be recorded normally.

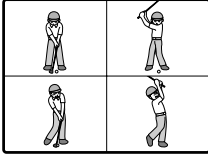
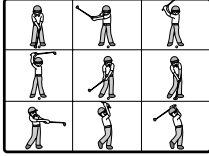
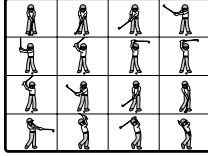
<p>4 Sequences</p> 	<p>9 Sequences</p> 	<p>16 Sequences</p> 
---	---	--

Availability of Digital Effects by Operating Modes:

	CAMERA		PLAY (VCR)	CARD CAMERA	CARD PLAY
	Movies	Still Images			
Faders	○	×	○	×	×
Effects	○	×	○	○*	×
Multi-image screen	○	×	○	×	×

○: Available ×: Not available

* : Black and White only.

Selecting a Fader

In CAMERA mode, set the program selector to .



1. Press the DIGITAL EFFECTS button.

[D.EFFECT , [FADER], [EFFECT] and [MULTI-S] appear.

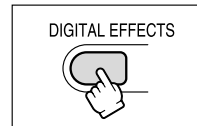

2. Select [FADER].

3. Select the fader option.

4. Press the DIGITAL EFFECTS button.

The name of the selected fader flashes.

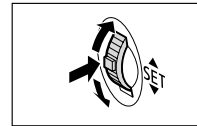

CAMERA mode:

5. Fade in: In record pause mode, press the ON/OFF button and begin recording by pressing the start/stop button.

Fade out: During recording, press the ON/OFF button and pause recording by pressing the start/stop button.

The fader can be activated/deactivated by pressing the ON/OFF button.

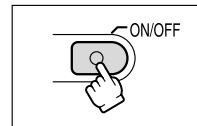

PLAY (VCR) mode:

5. Fade in: In playback pause mode, press the ON/OFF button and begin playback by pressing the ►/|| button.

Fade out: During playback, press the ON/OFF button and pause playback by pressing the ►/|| button.

The fader can be activated/deactivated by pressing the ON/OFF button.

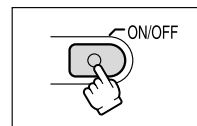

Selecting an Effect

In CAMERA mode, set the program selector to .

CAMERA

PLAY (VCR)

CARD CAMERA

CARD PLAY

1. Press the DIGITAL EFFECTS button.

[D.EFFECT , [FADER], [EFFECT] and [MULTI-S] appear.

DIGITAL EFFECTS



2. Select [EFFECT].

3. Select the effect.



4. Press the DIGITAL EFFECTS button.

The name of the selected effect flashes.

DIGITAL EFFECTS



5. Press the ON/OFF button.

- The name of the selected effect stops flashing.
- The effect can be activated/deactivated by pressing the ON/OFF button.

ON/OFF



Selecting an Effect in CARD CAMERA Mode

CAMERA

PLAY (VCR)

CARD CAMERA

CARD PLAY

1. Press the DIGITAL EFFECTS button.

"BLK&WHT" flashes.

DIGITAL EFFECTS



2. Press the ON/OFF button.

- "BLK&WHT" stops flashing.
- The effect can be activated/deactivated by pressing the ON/OFF button.

ON/OFF



Using the Multi-Image Screen

You can operate the multi-image screen only in the following playback modes:

- When [S.SPEED] is set to [MANUAL]: Playback pause, slow forward/reverse playback
- When [S.SPEED] is set to [FAST], [MOD.] or [SLOW]: Playback pause

In CAMERA mode, set the program selector to .



1. Press the DIGITAL EFFECTS button.

[D.EFFECT , [FADER], [EFFECT] and [MULTI-S] appear.

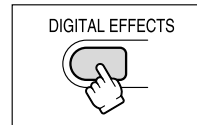

2. Select [MULTI-S].

[S.SPEED] and [S.SPLIT] appears.

3. Select [S.SPEED].

[MANUAL], [FAST], [MOD.] and [SLOW] appear.

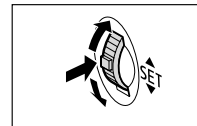

4. Select the transition speed.

Following transition speeds can be selected: fast (every 4 frames), moderate (every 6 frames*), slow (every 8 frames*).

* In Low Light mode: moderate (every 8 frames), slow (every 12 frames).

5. Select [MULTI-S] again.

[S.SPEED] and [S.SPLIT] appears.

6. Select [S.SPLIT].

[4], [9], [16] settings appear.

7. Select the number of sequences.

8. Press the DIGITAL EFFECTS button.

"MULTI-S" flashes.

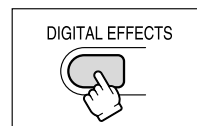

9. Press the ON/OFF button.

- MANUAL: Images will be captured each time you press the ON/OFF button. The blue frame indicating the next sequence disappears after the last image. To cancel the last captured image, press and hold the ON/OFF button. To cancel the multi-image screen, press and release the ON/OFF button.
- FAST, MODERATE, SLOW: The set number of images will be captured at the set speed. To cancel the multi-image screen, press the ON/OFF button.

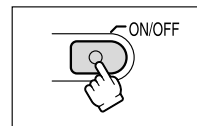

10. Press the start/stop button to begin recording.

The multi-image screen is recorded on the tape.



- Turn off the digital effect when you do not use it.
Press the DIGITAL EFFECTS button to open the menu. Select [D.EFFECT OFF] and press the DIGITAL EFFECTS button.
- The camcorder retains the setting even if you turn it off or change the program AE mode.
- The image quality may be slightly lower with digital effects.
- Digital effects cannot be used in the following cases:
 - When the program selector is set to .
 - During DV dubbing.
- Faders cannot be used when Card Mix is activated.

About the multi-image screen:

- The multi-image screen cannot be used in the following cases:
 - In the night modes.
 - When the 16:9 format is selected.
 - When Card Mix is activated.
- In PLAY (VCR) mode: Pressing any tape operation button (such as play or pause), or performing date search cancels the multi-image screen.

Magnifying the Image

The playback image can be magnified up to 5 times.

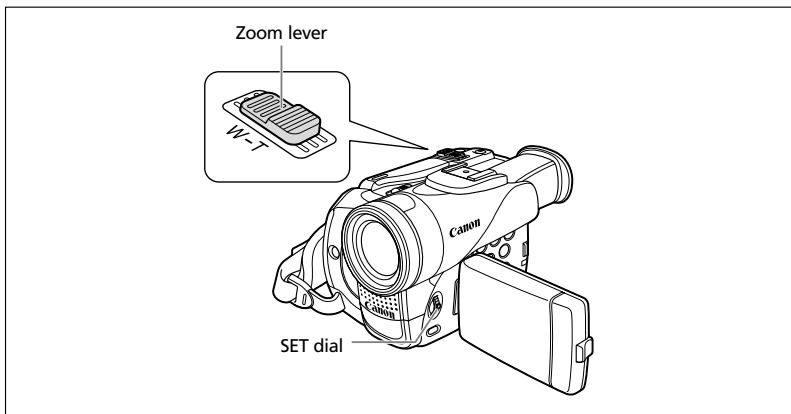

1. Move the zoom lever toward **T**.

- The image is magnified by 2 times.
- A frame appears indicating the position of the magnified area.
- To further enlarge the image, move the zoom lever toward **T**.

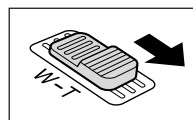

To shrink the image below 2 times magnification, move the zoom lever toward **W**.

2. Select the magnified area with the SET dial.

- Turn the SET dial to move the image to the right and left, or up and down. Pressing the SET dial switches between the directions.
- To cancel the magnification, move the zoom lever toward **W** until the frame disappears.



Movies played back from a memory card cannot be magnified.

E

Advanced Functions -
Playback

Displaying the Data Code

The camcorder maintains a data code containing recording date and time and other camera data such as shutter speed and exposure (f-stop). When you play back a tape, you can display the data code and select the data code combination you wish to display.

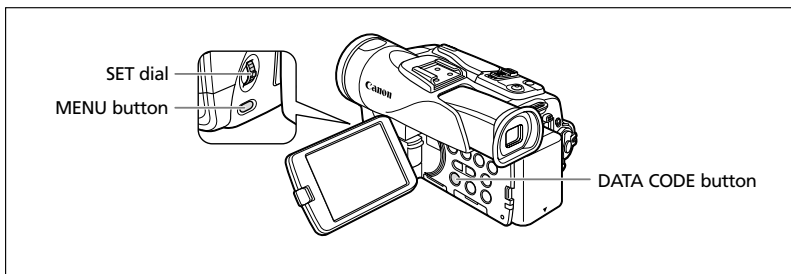

Selecting the Date/Time Display Combination

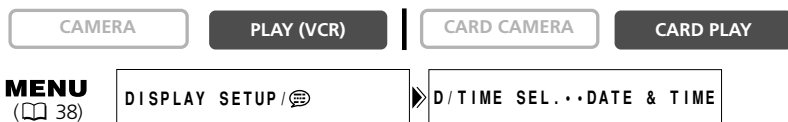

Open the menu and select [DISPLAY SETUP/[]]. Select [D/TIME SEL.], set it to [DATE] or [TIME] and close the menu.

Selecting the Data Code Display Combination



Open the menu and select [DISPLAY SETUP/[]]. Select [DATA CODE], set it to [CAMERA DATA] or [CAM. & D/T] and close the menu.

Displaying the Data Code



E

Press the **DATA CODE** button.



- The data code display turns off when you turn the camcorder off.
- Only date and time appear in **CARD PLAY** mode.

Six-Second Auto Date

Date and time appear for 6 seconds when you begin playback, or to indicate that date or time zone has changed.



MENU

(38)

DISPLAY SETUP /

▶▶ 6SEC.DATE...OFF

Open the menu and select **[DISPLAY SETUP/]**. Select **[6SEC.DATE]**, set it to **[ON]** and close the menu.

End Search

When you have played back a tape, you can use this function to locate the end of the last recorded scene.

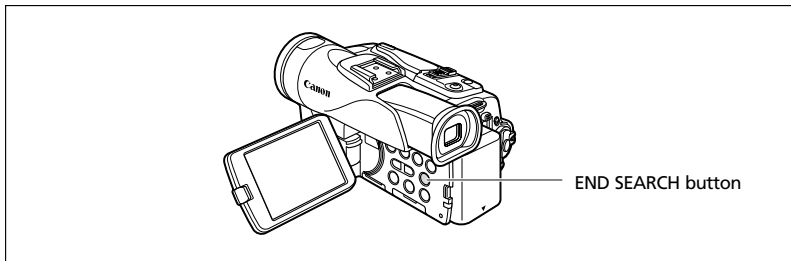

In stop mode, press the END SEARCH button.

- "END SEARCH" appears.
- The camcorder rewinds/fast forwards the tape, plays back the last few seconds of the recording and stops the tape.
- Pressing the button again cancels the search.



- End search cannot be used once you unload the cassette.
- End search may not work properly if a blank section exists on the tape.
- You cannot use end search to locate the editing end of audio dubbing.

Returning to a Pre-marked Position

If you wish to return to a particular scene later, mark the point with the zero set memory and the tape will stop at that point when you rewind/fast forward the tape. This function is operated with the wireless controller.

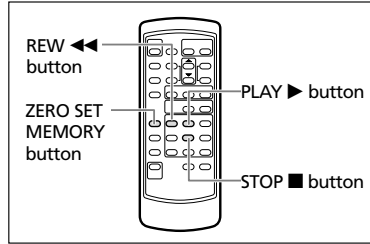

E



1. Press the ZERO SET MEMORY button at the point you wish to return to later.

- "0:00:00 M" appears.
- To cancel, press the ZERO SET MEMORY button again.

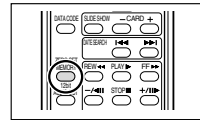

2. When you have finished playback, rewind the tape.

- "◀◀ RTN" appears.
- The tape stops automatically at "0:00:00".
- The tape counter changes to time code.



The zero set memory may not function correctly when the time code has not been recorded consecutively.

Advanced Functions -
Playback

Date Search

You can locate the change of the date/time zone with the date search function. This function is operated with the wireless controller.

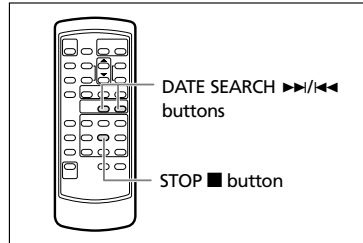

Press the >>> or <<< button to begin searching.

- Press more than once to search for further date changes (up to 10 times).
- Press the STOP ■ button to stop searching.

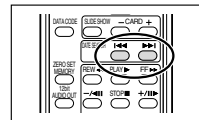

- A recording of longer than a minute per date/area is required.
- Date search may not function if the data code is not correctly displayed.

Customizing the Camcorder

You can personalize your camcorder by customizing the start-up image and the sound it makes for start-up, shutter, operation and self-timer (collectively called the My Camera settings).

E

Changing the My Camera Settings

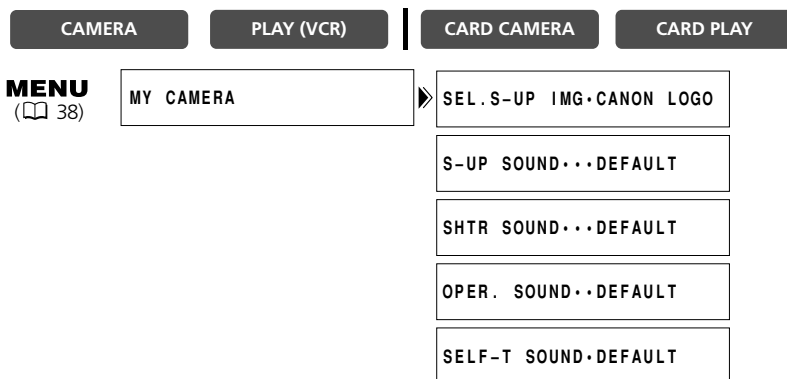

1. Open the menu and select [MY CAMERA].
2. Select the menu item you wish to change.

When selecting a start-up image, set the camcorder to CARD PLAY mode.

3. Select a setting option and close the menu.



- You can save your original images, or the images and sounds contained in the supplied software (ZoomBrowser EX for Windows or ImageBrowser for Macintosh) to the setting options [MY IMAGE] and [MY SOUND]. For details, refer to the *Digital Video Software Instruction Manual*.
- You can also create original start-up images (📖 118).

Changing the Display Language

The language used in the camcorder displays and menu items can be changed to German, Spanish, French, Italian, Russian, Simplified Chinese or Japanese.



To change the display language, open the menu and select [DISPLAY SETUP/[speech bubble icon]]. Select [LANGUAGE [speech bubble icon]], select a language and close the menu.

 If you have mistakenly changed the language, follow the [speech bubble icon] mark next to the menu item to change the setting.

Changing the Date Format

You can select between three date formats. For example, [JAN. 1, 2004], [1. JAN. 2004] and [2004. 1. 1].

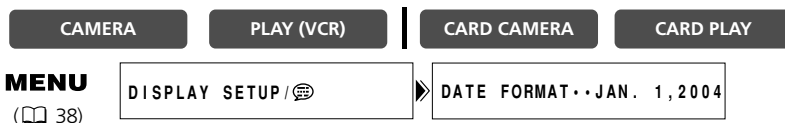

Open the menu and select [DISPLAY SETUP/[speech bubble icon]]. Select [DATE FORMAT], select a format and close the menu.

Changing the Remote Sensor Mode

Two remote sensor modes and an off setting are available to prevent interference from other Canon wireless controllers being used nearby.

E

Turning the Remote Sensor Off



Open the menu and select [SYSTEM]. Select [WL. REMOTE], set it to [OFF (OFF)], and close the menu.

“(OFF)” appears.

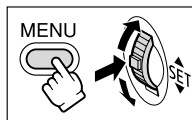

Changing the Remote Sensor Mode



1. On the camcorder, open the menu and select [SYSTEM]. Select [WL. REMOTE], set it to [2] and close the menu.

The selected mode appears for a few seconds.

2. On the wireless controller, press and hold the REMOTE SET button. Press the ZOOM T button for mode 2. Keep the button pressed for over 2 seconds.

If you have set the camcorder to mode 1, press the ZOOM W button for mode 1.

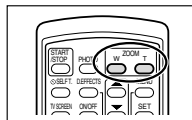
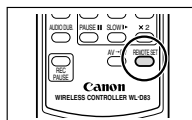
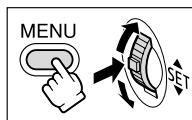

- The wireless controller returns to mode 1 when you replace the batteries. Change the mode if necessary.
- Make sure that camcorder and wireless controller are set to the same mode. Display the camcorder's mode by pressing any button on the wireless controller (except of the REMOTE SET button) and set the wireless controller's mode to the same mode. Change the batteries if the wireless controller still does not work.

Other Camcorder Settings

Beep

You will hear a beep upon camcorder operations such as power on/off, start/stop, self-timer countdown, and unusual conditions of the camcorder.

If you turn off the beep, all camcorder sounds including the ones of the My Camera settings will be turned off.

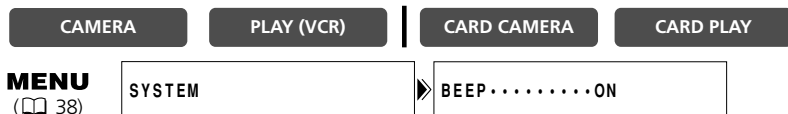

To turn the beep off, open the menu and select [SYSTEM]. Select [BEEP], set it to [OFF] and close the menu.

Recording in 16:9 (Widescreen TV Recording)

You can record videos in 16:9 widescreen format.

ELUR470/ELUR469 The camcorder uses the full width of the CCD providing high-resolution 16:9 recording. When you turn off the image stabilizer, you will get a larger horizontal angle of view.

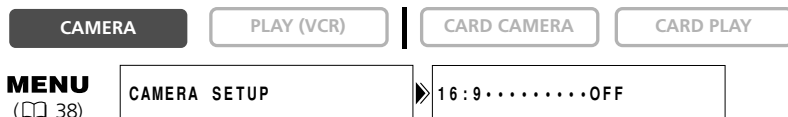

To switch 16:9 on, open the menu and select [CAMERA SETUP]. Select [16:9], set it to [ON] and close the menu.

“16:9” appears.



- The 16:9 mode cannot be selected in the Easy Recording mode.
- The multi-image screen cannot be used when the 16:9 format is selected.
- Simultaneous recording on a memory card cannot be used when the 16:9 format is selected.
- If you play back a 16:9 recording on a normal TV, the image appears vertically compressed.
- If you connect the camcorder to a TV with an S1 terminal or Video ID-1 system, recordings made in the 16:9 mode will be automatically played back in widescreen mode.

Turning Off the Image Stabilizer

The image stabilizer compensates for camcorder shake even at full telephoto. It tries to compensate for horizontal movements; therefore, you may decide to turn it off when you mount the camcorder on a tripod.

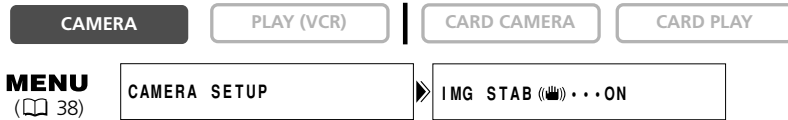

Open the menu and select [CAMERA SETUP]. Select [IMG STAB (👤)], set it to [OFF] and close the menu.

“(👤)” disappears.



- The image stabilizer cannot be turned off when the program selector is set to .
- The image stabilizer is designed to compensate a normal degree of camcorder shake.
- The image stabilizer might not be as effective when using the night modes.

Demonstration Mode

The demonstration mode displays the camcorder's main features. It starts automatically when you leave the camcorder turned on without loading a recording media for more than 5 minutes. However, you can set the camcorder not to start the demonstration mode.



Open the menu and select [DISPLAY SETUP/🌐]. Select [DEMO MODE], set it to [OFF] and close the menu.



To cancel the demo mode once it has begun, press any button, turn off the camcorder or load a recording media.





ELURA 70/ELURA 6S **Using the VFL-1 Video Flash Light (Optional)**

The video flash light attaches to the camcorder's "S" advanced accessory shoe for cable-free operation and is powered by the camcorder's power supply.

The video light can be used for recording movies and still images, and the flash for recording still images. As a flash, it can be set to fire automatically or act as a pre-flash to reduce the red-eye effect.

For how to attach the video flash light and how to use the video light, refer to the VFL-1 Video Flash Light instruction manual.

Selecting the Flash Mode

AUTO 	The flash fires automatically according to the brightness of the subject.
RED-EYE 	The flash fires automatically according to the brightness of the subject, and fires a pre-flash for red-eye reduction.
FLASH ON 	The flash always fires.
FLASH OFF 	The flash does not fire. Use this setting in places where flash photography is prohibited.





1. Set the video flash light's POWER switch to  ON.
2. Open the menu and select [CAMERA SETUP]. Select [FLASH], select a setting option and close the menu.





The symbol of the selected flash mode appears on the screen. "  " disappears after 4 seconds.



- Do not fire the flash close to people's eyes.
- Do not fire the flash at persons while they are driving.
- Do not fire the flash with the flash bulb covered with your hand.



- The practical range of the flash is approx. 3.3 to 6.6 ft. (1 to 2 m). The range depends upon the recording condition.
- In CAMERA mode, the flash can be used in record pause mode when [STILL I. REC] is set to [ FINE] or [ NORMAL].
- The range of the flash decreases in continuous shooting mode.
- In normal and high-speed continuous shooting mode, images are captured at 2 frames/second when using the flash.

- A pre-flash is fired to obtain the subject's exposure data to adjust the main flash to the optimal intensity (flash exposure compensation). When [RED EYE ] is set, the pre-flash fires between the flash for red-eye reduction and the main firing.
- The flash will not fire in the following cases:
 - When you press the EXP button in [AUTO ] or [RED-EYE ] mode.
 - During auto exposure bracketing (the flash mark appears in purple).
 - When a shutter speed of 1/2000 is set in CAMERA mode (the flash mark appears in purple). However, if [FLASH ON ] is selected, the shutter speed becomes set to 1/1000 and the flash fires.
 - When an abnormality occurs during charging (the flash mark flashes in red).
 - When the multi-image screen is selected, when you are recording movies onto a tape or when [STILL I. REC] is set to [OFF] (no flash mark appears).
- We recommend not using the flash when the wide attachment (supplied with the ELURA70), the optional Wide-converter or Tele-converter is attached. Their shadows appear on the screen.
- The flash mode cannot be selected when exposure is locked, or after the first still image in Stitch Assist mode.
- The red-eye reduction mode cannot be used in stitch assist mode.
- **About the AF-Assist Lamp:**

When recording still images with flash, the AF-assist lamp (white LED) lights up responding to the brightness of the subject to enable the camcorder to focus more accurately. The AF-assist lamp lights up when you focus manually while the PHOTO button is pressed halfway and turns off after a short time.

 - The camcorder may not be able to focus even though the AF-assist lamp is lighting.
 - The AF-assist lamp lights up brightly. Consider turning off the AF-assist lamp in public places such as in restaurants or theaters.
 - Turn off the AF-assist lamp in places where flash photography is prohibited.

Recording to a VCR or Digital Video Device

You can copy your recordings by connecting the camcorder to a VCR or a digital video device. If you connect a digital video device, you can copy recordings with virtually no generation loss in image and sound quality.

Connecting the Devices

① Connecting a VCR

See *Playing Back on a TV Screen* (35).

② Connecting a Digital Video Device

Refer also to the instruction manual of the digital video device.

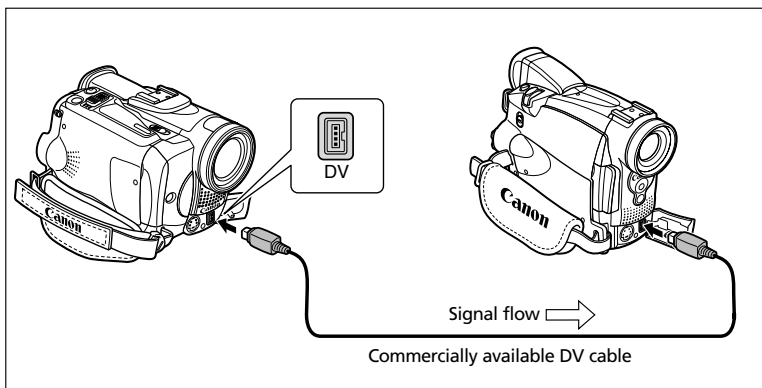

Recording

CAMERA

PLAY (VCR)

CARD CAMERA

CARD PLAY

1. **Set the camcorder to PLAY (VCR) mode and load a recorded cassette.**
If you are connecting via AV terminal, check the setting (35).
2. **Connected device: Load a blank cassette and set the device to record pause mode.**
3. **Locate the scene you wish to copy and pause playback shortly before the scene.**
4. **Play back the tape.**
5. **Connected device: Begin recording when the scene you wish to copy appears. Stop recording when copying is complete.**
6. **Stop playback.**



- When connecting a VCR, the quality of the edited tape will be slightly lower than that of the original.
- When connecting a digital video device:
 - If the picture does not appear, reconnect the DV cable or turn the camcorder off and back on again.
 - Proper operation cannot be guaranteed for all digital video devices equipped with a DV terminal. If operation does not work, use the S-video or AV terminal.



Recording from Analog Video Devices (VCR, TV or Camcorder)

You can record videos or TV programs from a VCR or analog camcorder on the tape in the camcorder.

CAMERA

PLAY (VCR)

CARD CAMERA

CARD PLAY

1. Connect the camcorder to the analog video device.

See *Playing Back on a TV Screen* (📖 35).

2. Set the camcorder to PLAY (VCR) mode and load a blank cassette.

3. Connected device: Load the recorded cassette.

4. Press the REC PAUSE button.

In record pause mode and during recording, you can check the picture on the screen.

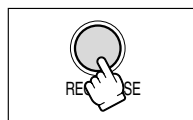

5. Connected device: Play back the tape.

6. Press the ►/|| button when the scene you wish to record appears.

Recording starts.

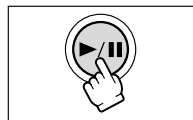

7. Press the ■ button to stop recording.

- Press the ►/|| button to pause recording.
- Press the ►/|| button again to restart recording.

8. Connected device: Stop playback.

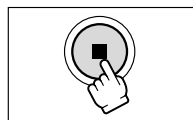

Headphones cannot be used during analog line-in recording.

Recording from Digital Video Devices (DV Dubbing)

E

You can record from other digital video devices equipped with a DV terminal with virtually no loss in picture and sound quality.



1. Connect the camcorder to the digital video device.

See *Connecting a Digital Video Device* (□ 82).

2. Set the camcorder to PLAY (VCR) mode and load a blank cassette.

Make sure that [AV→DV OUT] is set to [OFF] (□ 87).

3. Connected device: Load the recorded cassette.

4. Press the REC PAUSE button.

In record pause mode and during recording, you can check the picture on the screen.



5. Connected Device: Play back the tape.

6. Press the ►/|| button when the scene you wish to record appears.

Recording starts.

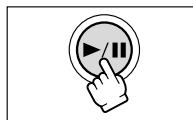

7. Press the ■ button to stop recording.

- Press the ►/|| button to pause recording.
- Press the ►/|| button again to restart recording.

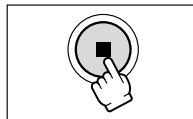

8. Connected Device: Stop playback.



- Blank sections may be recorded as anomalous picture.
- If the picture does not appear, reconnect the DV cable or turn the camcorder off and back on again.
- You can only record signals from devices with the DV logo recording in SD system in SP or LP format.

Copyright Signal

Certain software tapes are copyright protected. If you attempt to play back such tape, "COPYRIGHT PROTECTED PLAYBACK IS RESTRICTED" appears and you will not be able to view the contents of the tape. If you attempt to record from such tape via the DV terminal, "COPYRIGHT PROTECTED DUBBING RESTRICTED" appears and you will not be able to record the contents of the tape.

Editing

Converting Analog Signals into Digital Signals (Analog-Digital Converter)

By connecting the camcorder to a VCR or 8mm video camcorder, you can convert analog video/audio signals to digital signals and output the digital signals via the DV terminal. The DV terminal serves as output terminal only.

Connecting the Devices

Turn off all devices before starting the connections. Unload the tape from the camcorder. Refer also to the instruction manual of the connected device.

You can also connect a VCR with S (S1)-VIDEO terminal (□ 36).

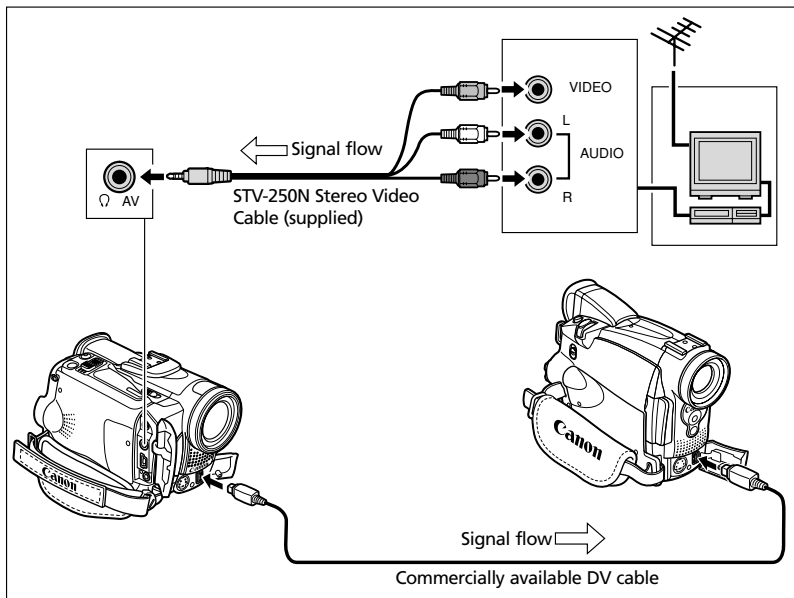

Turning On the Analog-Digital Converter



E

Open the menu and select [VCR SETUP]. Select [AV to DV OUT], set it to [ON] and close the menu.



- Headphones cannot be used during analog-digital conversion.
- Depending on the signal sent from the connected device, the conversion from analog to digital signals might not work properly (e.g., signals that include copyright protective signals or anomalous signals such as ghost signals).
- For normal use, set [AV to DV OUT] to [OFF]. If it is set to [ON], digital signals cannot be input via the camcorder's DV terminal.
- Depending on the software and the specifications of your computer, you may not be able to transfer converted signals via the DV terminal.



- We recommend powering the camcorder from a household power source.
- You can also press the AV to DV button on the wireless controller. The setting changes with each press of the button.

Audio Dubbing

You can add sound from audio devices (AUDIO IN) or with the built-in microphone (MIC. IN). With the ELURA70/ELURA65, you can also use an external microphone (MIC. IN).

This function is operated with the wireless controller.

Connecting

① Connecting an Audio Device

Refer also to the instruction manual of the connected device.

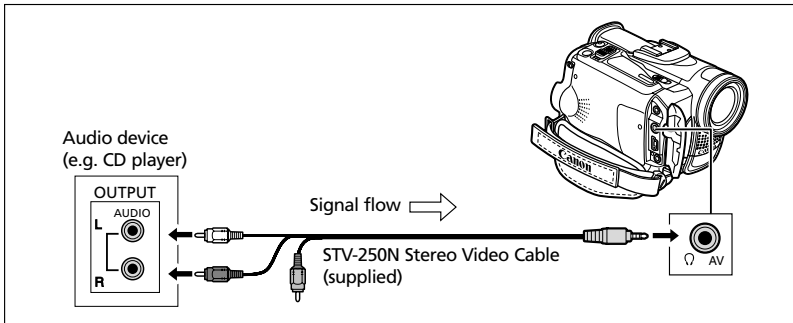

② ELURA 70/ELURA 65 Connecting a Microphone

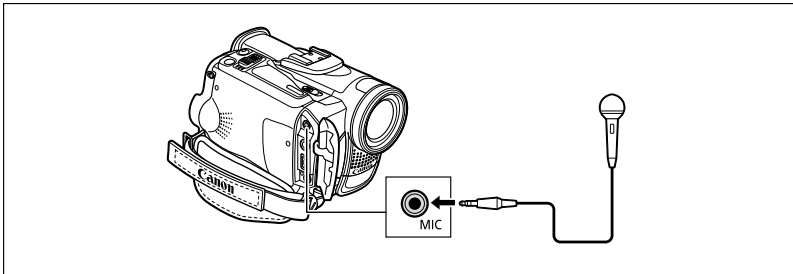

When using the built-in microphone, do not connect any cables to the MIC terminal.

Dubbing



E

1. Set the camcorder to **PLAY (VCR)** mode and load a recorded cassette.

Use a tape recorded in SP, 12-bit mode with this camcorder.

2. Open the menu and select **[AUDIO SETUP]**. Select **[AUDIO DUB.]**, set it to **[AUDIO IN]** or **[MIC. IN]** and close the menu.

3. Locate the scene you wish to start audio dubbing.

4. Press the **PAUSE** **||** button on the wireless controller.

5. Press the **AUDIO DUB.** button on the wireless controller.

"AUDIO DUB." and " **||** " appear.

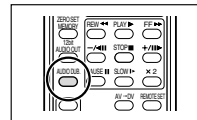

6. Press the **PAUSE** **||** button on the wireless controller to begin dubbing.

- Audio device: Begin playback.
- Microphone: Speak into the microphone.

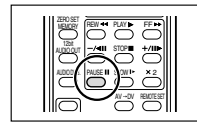

7. Press the **STOP** **■** button on the wireless controller to stop dubbing.

Audio device: Stop playback.

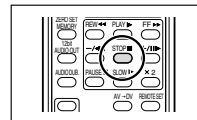

Editing



- Use only tapes recorded in SP mode 12-bit audio sound with this camcorder. Audio dubbing will stop if the tape has a blank section or a section recorded in LP mode or 16-bit mode.
- You cannot use the DV terminal for audio dubbing.
- If you add sound to a tape not recorded with this camcorder, sound quality may decrease.
- Sound quality may decrease when you add sound to the same scene for more than 3 times.



- When you connect an audio device, check the picture on the LCD screen and the sound via built-in speaker or audio device. You can also connect a TV via S-video terminal.
- When you use the built-in microphone, you can either connect a TV via AV terminal to check the picture, or headphones to check the sound. When you connect a TV via S-video terminal, you can check the picture on the TV screen and the sound with headphones connected to the camcorder.
- Set the zero set memory at the end of the scene you wish to dub audio. The camcorder will automatically stop audio dubbing at that point.

Playing Back the Added Sound

You can select to play back Stereo 1 (original sound), Stereo 2 (added sound), or adjust the balance of both sounds.



1. Open the menu and select [AUDIO SETUP]. Select [12bit AUDIO], select a setting and close the menu.

- STEREO 1: Plays back the original sound.
- STEREO 2: Plays back the added sound.
- MIX/FIXED: Plays back stereo 1 and stereo 2 in the same level.
- MIX/VARI.: Plays back stereo 1 and stereo 2. The mix balance can be adjusted.

2. If you have selected [MIX/VARI.], adjust the mix level: Open the menu and select [AUDIO SETUP]. Select [MIX BALANCE], adjust the balance with the SET dial and close the menu.

Turn the SET dial down to increase the volume of Stereo 1 and up to increase the volume of Stereo 2.



- The camcorder resets to [STEREO 1] when you turn the camcorder off. However, the mix balance is memorized by the camcorder.
- You can also press the 12bit AUDIO OUT button on the wireless controller to select the audio output. However, the mix balance can only be adjusted in the menu.

Connecting to a Computer Using a DV (IEEE1394) Cable

You can transfer recordings to a computer equipped with a IEEE1394 (DV) terminal or IEEE1394 capture board. Optional software is required for transferring recordings from the tape to a computer. Refer to the instruction manual of the software.

E

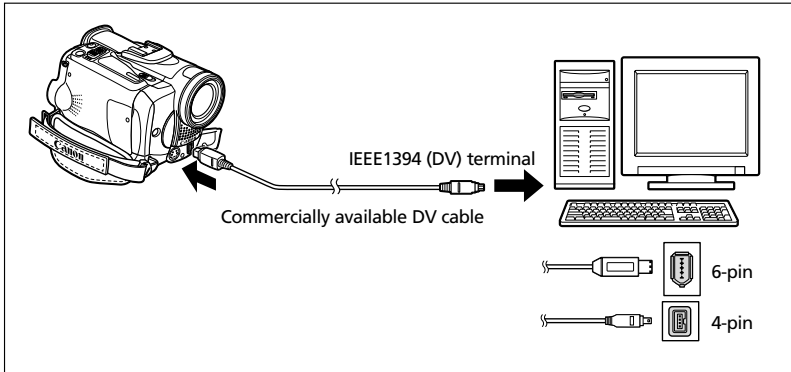

- Operation may not work correctly depending on the software and the specifications/settings of your computer.
- If the computer freezes while you have connected the camcorder, disconnect and reconnect the DV cable. If the problem persists, disconnect the interface cable, turn off camcorder and computer, turn camcorder and computer back on and reconnect them.
- Do not disconnect the DV cable, open the memory card cover, remove the memory card, change the position of the POWER switch or turn off the camcorder and computer while data is being transferred to the computer (while the camcorder's card access indicator is flashing). Doing so may damage the memory card's data.
- The image files on your memory card and the image files saved on the hard disk drive of your computer are valuable, original data files. If you wish to use image files on your computer, make copies of them first, and use the copied file, retaining the original.



- We recommend powering the camcorder from a household power source while it is connected to the computer.
- Refer also to the instruction manual of the computer.
- Users of Windows XP can use the supplied DV Network Software. For details, refer to the *DV Network Software Instruction Manual*.

Inserting and Removing a Memory Card

You can use **SD** SD Memory Cards or commercially available MultiMediaCards with this camcorder. The SD Memory Card has a protect switch to prevent accidental erasure.

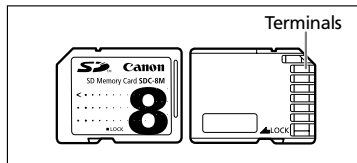

Inserting the Card

1. Turn off the camcorder.
2. Open the cover.
3. Insert the memory card all the way into the memory card slot.
4. Close the cover.

Do not close the cover forcefully without having the card correctly inserted.

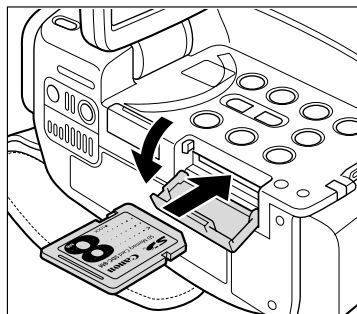

Removing the Card

Do not forcefully remove the memory card without first pushing it in.

1. Turn off the camcorder.
Make sure that the card access indicator is not flashing before you turn off the camcorder.
2. Open the cover.
3. Push the memory card to release it.
Remove the memory card.
4. Close the cover.

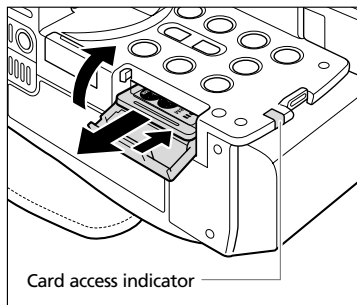

- This camcorder is compatible with SD Memory Cards or MultiMediaCards only. Do not use any other types of memory cards.
- Turn off the camcorder before inserting or removing the memory card. Otherwise, it may result in data damage.
- If you use memory cards other than the supplied one, make sure to format them with the camcorder (📖 117).

Selecting the Image Quality/Size

Changing the Still Image Quality

You can choose between Superfine, Fine and Normal.



Open the menu and select [CARD SETUP]. Select [IMG QUALITY], set it to [SUPER FINE] or [NORMAL] and close the menu.

Changing the Still Image Size

You can choose between 1280 × 960 pixels and 640 × 480 pixels.



Open the menu and select [CARD SETUP]. Select [IMAGE SIZE], set it to [640×480] and close the menu.



- Still images are compressed and recorded in the JPEG (Joint Photographic Experts Group) format.
- Estimated Capacity of an 8 MB Memory Card:

Image Size	1280 × 960		640 × 480	
	No. of Images	File Size per Image	No. of Images	File Size per Image
Superfine	6	850 KB	34	175 KB
Fine	10	550 KB	50	120 KB
Normal	18	300 KB	84	65 KB

These figures are approximate. They vary according to the recording condition and the subject. Sample images already recorded on the supplied SD Memory Card are to be included in the total number.

Changing the Movie Size

You can choose between 320×240 pixels and 160×120 pixels.

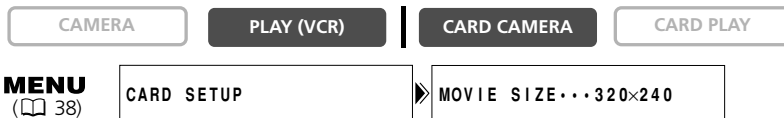

Open the menu and select [CARD SETUP]. Select [MOVIE SIZE], set it to [160x120] and close the menu.



- Movies are recorded in the Motion JPEG format.
- Maximum recording time on a 8 MB SD Memory Card:

Image Size	Max. Recording Time (8 MB)	File Size per Second
320×240	approx. 20 sec.	250 KB/sec.
160×120	approx. 50 sec.	120 KB/sec.

Approx. 69 min. on a 512 MB SD Memory Card.

File Numbers

E

Images are automatically assigned file numbers from 0101 to 9900 and stored in folders containing up to 100 images. Folders are assigned numbers from 101 to 998. (The sample images on the supplied memory card are saved in the [100canon] folder.)

You can choose to use consecutive file numbers (CONTINUOUS) or to reset the file number each time a different memory card is inserted (RESET). We recommend setting the file numbers to CONTINUOUS.

RESET	The file number will be reset each time a new memory card is inserted, starting with 101-0101. If the memory card already contains image files, the consecutive file number will be assigned.
CONTINUOUS	The camcorder memorizes the file number of the last image and assigns the consecutive file number to the next image, even when a new memory card is inserted. (If a higher file number already exists on the memory card, the consecutive number will be assigned.) There will be no duplication of file numbers. This is useful for organizing images on a computer.

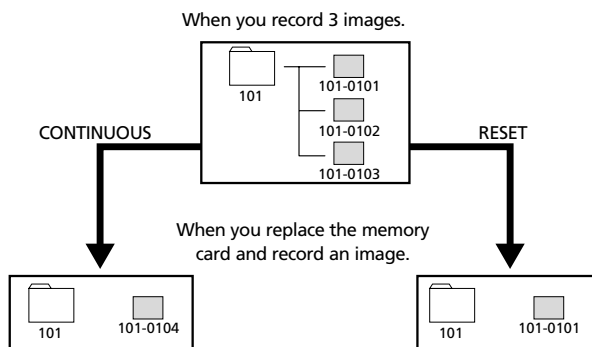

MENU
(38)

CARD SETUP

FILE NOS. . . . CONTINUOUS

To change the setting, open the menu and select [CARD SETUP]. Select [FILE NOS.], set it to [RESET] and close the menu.

Using a Memory Card

Recording Still Images on a Memory Card

You can record still images with the camcorder, from a tape in the camcorder or from devices connected via the DV terminal or AV terminal. You can also record a still image on the memory card while you record a movie on the tape.

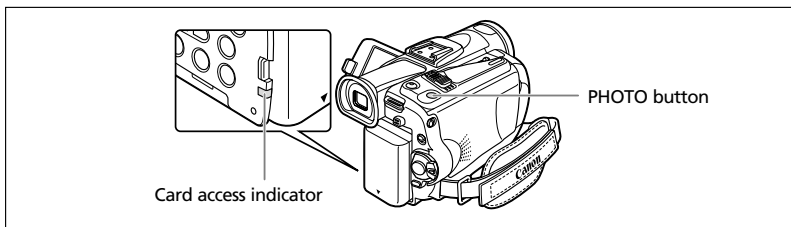

1. Set the camcorder to **CARD CAMERA** mode.

A white focusing frame appears in the center of the screen. The camcorder will focus on the subject in the center of the screen. To change the focusing point, see *Selecting the Focusing Point* (📖 103).

2. Press the **PHOTO** button halfway.

- ● and focusing frame turn green when focus is adjusted. The beep sounds twice. The picture may appear out of focus for a moment while the camcorder is focusing.
- Exposure is locked.
- When you press the PHOTO button on the wireless controller, recording starts immediately.

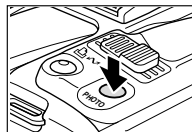

3. Press the **PHOTO** button fully.

- ● and focusing frame disappear and you hear a shutter sound.
- The card access indicator flashes and the card access display appears.
- The still image shown on the screen will be recorded on the memory card.

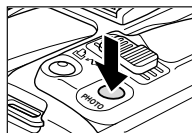

- Do not turn off the camcorder, change the position of the TAPE/CARD switch, disconnect the power source, open the memory card cover or remove the memory card while the card access indicator is flashing. Doing so could result in data damage.
- When you are using a SD Memory Card, make sure that the protect switch is set to allow recording.



- Connection to a computer or PictBridge compliant printer will not work when the memory card contains more than 1800 images. For best performance, we recommend not recording more than 100 images on the memory card when you plan to connect the camcorder to a computer or printer.
- When the subject is too bright, the ND filter turns on automatically (“ND” appears on the screen). If it is still too bright, “OVEREXP” starts flashing. In such case, use the optional FS-34U ND filter. If you wish to turn off the ND filter: Open the menu and select [CAMERA SETUP]. Select [ND], set it to [OFF] and close the menu.
- **When the Focus-Priority mode is set to [ON]:**
When you press the PHOTO button fully before ● and focusing frame turn green, it may take up to 2* seconds until focus is adjusted and the still image can be recorded to the memory card.
* Up to 4 seconds in the Low Light and the night modes.
If the subject is not suitable for autofocus, the focusing frame turns yellow and locks the focus. Adjust the focus manually with the SET dial.
- **When the Focus-Priority mode is set to [OFF]:**
No focusing frame appears.
In step 2, ● turns green, and focus and exposure are locked.
- The camcorder shuts off when you do not operate it for 5 minutes to save power. “⚠️ AUTO POWER OFF” appears 20 seconds before shutoff. To continue recording, turn the POWER switch to OFF and then back to CAMERA.

Recording a Still Image on a Memory Card While Recording Movies on a Tape

When you are recording a movie on a tape, you can record the same picture as a still image on the memory card. Select the image quality from normal or fine.

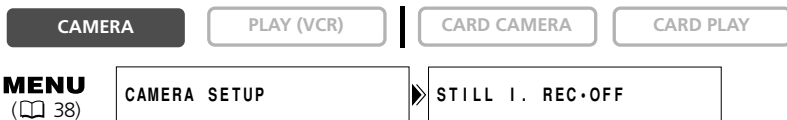

1. Open the menu and select [CAMERA SETUP]. Select [STILL I. REC], set it to [FINE] or [NORMAL] and close the menu.
2. While you are recording a movie, press the PHOTO button.



- The size of the still image will be 640 × 480.
- The quality of the still image is slightly lower than a still image recorded in CARD CAMERA mode.
- The still image cannot be recorded on a memory card when a fader, effect or the multi-image screen is activated.
- The still image cannot be recorded on a memory card when the 16:9 format is selected.
- Card mix cannot be used when [STILL I.REC] is set to [FINE] or [NORMAL].
- “⚠️ OFF” appears when you press the PHOTO button when [STILL I. REC] is set to [OFF].

Recording from a Tape in the Camcorder



1. Play back the tape.

2. Press the PHOTO button halfway when the scene you wish to record appears.

- The camcorder pauses playback. The remaining image capacity and other information appear.
- When you press the PHOTO button on the wireless controller, recording starts immediately.

3. Press the PHOTO button fully.

- The card access indicator flashes.
- You can also record a still image by pressing the PHOTO button fully when the tape is in playback pause mode.

Recording from Other Video Devices

You can record images from devices connected via the S-video terminal or AV terminal (analog line-in function), or via the DV terminal as still images on a memory card. For connecting instructions, refer to page 35 and 82.



1. Set the camcorder to PLAY (VCR) mode.

- If a cassette is loaded, make sure that the tape is stopped.
- When recording via the AV terminal, make sure that “AV →DV” is displayed on the screen. When recording via the DV terminal, make sure that “AV →DV” is not displayed. Change the setting as necessary (□ 87).

2. Connected device: Load a recorded cassette and play back the tape.

3. Press the PHOTO button halfway when the scene you wish to record appears.

- The still image, remaining image capacity and other information appear.
- When you press the PHOTO button on the wireless controller, recording starts immediately.

4. Press the PHOTO button fully.

The card access indicator flashes.



When recording from a tape in the camcorder or other video devices:

- A still image recorded from an image in 16:9 format will be vertically compressed.
- The data code of the still image will reflect the date and time it has been recorded on the memory card.
- The size of the still image will be 640 × 480.

E

Screen Displays during Still Image Recording



1 Still Image Quality
Indicates the image quality of the still image.

2 Remaining Card Capacity for Still Images

- flashing in red: No card
- in green: 6 or more images
- in yellow: 1 to 5 images
- in red: No more images

- The indication may not decrease even though a recording has been made, or may decrease by 2 images at once.
- All indicators are displayed in green when a memory card is played back.

"▶" Card Access Display

Indicates that the camcorder is writing on the memory card.

3 Image Size
Indicates the still image size.

Using a Memory Card

Reviewing a Still Image Right after Recording

You can select to display a still image for 2, 4, 6, 8 or 10 seconds after it has been recorded.



Open the menu and select [CAMERA SETUP]. Select [REVIEW], select a setting option and close the menu.



- A still image is displayed as long as you hold the PHOTO button after recording.
- The FILE OPER. menu appears when you press the SET dial while you are reviewing a still image, or when you press the SET dial right after recording. In this menu, you can protect (📖 111) or erase (📖 112) the image.
- [REVIEW] cannot be selected when 📷 (continuous shooting), 📷 (high-speed continuous shooting) or 📷 (auto exposure bracketing) is selected.

Recording Motion JPEG Movies on a Memory Card

You can record Motion JPEG movies with the camcorder, from a tape in the camcorder or from devices connected via the DV terminal or the AV terminal. The sound of a movie recorded on a memory card will be monaural.

E

CAMERA

PLAY (VCR)

CARD CAMERA

CARD PLAY

1. Press the start/stop button to begin recording.

- You can keep recording until “CARD FULL” appears.
- With MultiMediaCards, the recording time is limited to 10 sec. in 320 × 240 pixels and 30 sec. in 160 × 120 pixels.

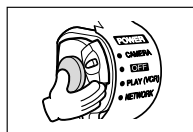

2. Press the start/stop button to stop recording.



- Do not turn off the camcorder, change the position of the TAPE/CARD switch, disconnect the power source, open the memory card cover or remove the memory card while the card access indicator is flashing. Doing so could result in data damage.
- When you are using a SD Memory Card, make sure that the protect switch is set to allow recording.
- Do not load/unload a cassette during recording.



- We recommend using a Canon SD Memory Card, or a SD Memory Card that guarantees a transfer rate of 2 MB/sec., right after you have formatted it with this camcorder. With memory cards not formatted with this camcorder, or when recording/erasing has been repeatedly performed, the writing speed may be lower and recording may stop.
- You can select the focusing point when recording a movie on the memory card.
- Users of Windows XP: When you plan to connect the camcorder to a computer, keep the length of one movie shorter than approx. 12 min. in 320 × 240 and 35 min. in 160 × 120.

Recording from a Tape in the Camcorder

CAMERA

PLAY (VCR)

CARD CAMERA

CARD PLAY

1. Play back the tape.

2. Press the start/stop button when the scene you wish to record appears.
3. Press the start/stop to stop recording.

Recording from Other Video Devices

You can record movies from devices connected via the S-video terminal or AV terminal (analog line-in function), or via the DV terminal on a memory card.

For connecting instructions, refer to page 35 and 82.

CAMERA

PLAY (VCR)

CARD CAMERA

CARD PLAY

1. Set the camcorder to PLAY (VCR) mode.

- If a cassette is loaded, make sure the tape is stopped.
- When recording via the AV terminal, make sure that "AV→DV" is displayed on the screen. When recording via the DV terminal, make sure that "AV→DV" is not displayed. Change the setting as necessary (□ 87).

2. Connected device: Load a recorded cassette and play back the tape.

3. Press the start/stop button when the scene you wish to record appears.

4. Press the start/stop button to stop recording.



When recording from a tape in the camcorder or other video devices:

- A movie recorded from an image in 16:9 format will be vertically compressed.
- The data code of the movie will reflect the date and time it has been recorded on the memory card.
- Recording stops at blank sections or recordings in different audio mode (12bit/16bit).

Screen Displays during Movie Recording

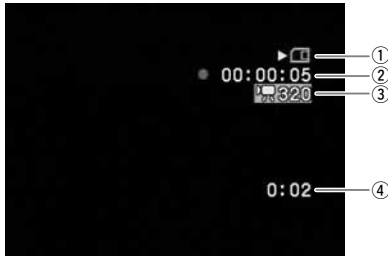

① "▶" Card Access Display

Indicates that the camcorder is writing on the memory card.

② Movie recording time

Indicates the recording time of the movie.

③ Image Size

Indicates the movie size.

④ Remaining Card Capacity for Movies

Indicates the remaining time in hours and minutes. At less than 1 minute, the remaining time will be displayed in 10 second-steps, at less than 10 seconds in 1 second-steps.

- The indication varies depending on the recording condition. The actual remaining time may be longer or shorter than indicated.

Selecting the Focusing Point

The subject you wish to record is not always in the center of the screen. In the Focus-Priority mode, you can choose from one of three focusing points to automatically put the subject you wish into sharp focus.

When the program selector is set to , the Focus-Priority becomes set to ON (only the center focusing point is available).



1. Set the program selector to .
2. Turn the SET dial to display all focusing frames.

Three focusing frames appear on the screen, one of it in green.

3. Turn the SET dial to select the focusing point.

Turn the SET dial up to select the frame to the right, down to select the frame to the left.



- The focusing frame gives an indication of the focusing point. Depending on the size of the subject or the distance, the camcorder may focus outside the frame.
- When you operate the zoom lever, the frames other than the selected one disappear.
- The focusing point can be selected only when Focus-Priority is set to [ON] in CARD CAMERA mode.
- The focusing point returns to the center if you turn off the camcorder, change from CARD CAMERA mode or move the program selector to .
- The focusing point cannot be selected in the following cases:
 - When using the digital zoom. When you zoom into the digital zoom range, the focusing frame flashes for 4 seconds and disappears. When you return to the optical zoom range, the focusing frame reappears.
 - In Stitch Assist mode.

Turning Off the Focus-Priority Mode

Turn off the Focus-Priority mode if you wish to put timing ahead of focus.





MENU
( 38)

CAMERA SETUP

FOCUS PRI...ON

Open the menu and select [CAMERA SETUP]. Select [FOCUS PRI.], set it to [OFF] and close the menu.

Selecting the Drive Mode

 Continuous Shooting	Captures a quick series of still images while you press the PHOTO button (3 frames/sec.).
 High-Speed Continuous Shooting	Captures a quick series of still images while you press the PHOTO button (5 images/sec.).
 AEB (Auto Exposure Bracketing)	The camcorder records a still image in three different exposures (dark, normal, light in 1/2 EV steps), allowing you to choose the perfect exposed shot.
Single	Records a single still image when you press the PHOTO button.

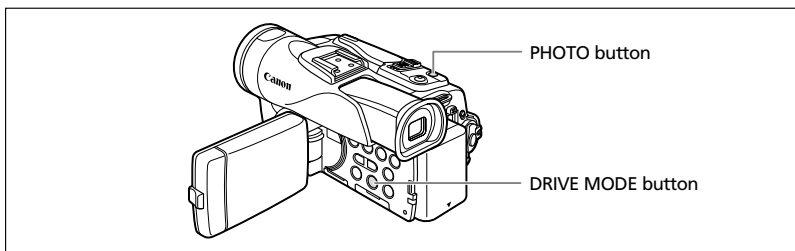

Changing the Drive Mode



Press the **DRIVE MODE** button to switch between the drive modes.

The setting changes with each press of the button.

Continuous Shooting/High-Speed Continuous Shooting



Press and hold the **PHOTO** button.

A series of still images will be recorded as long as you hold the PHOTO button.



○ Maximum number of continuous shots at one time:

Still Image Size	Frames per Second		Maximum Number of Continuous Shots
	Normal speed	High speed	
1280 × 960	3 frames	5 frames	10 images
640 × 480	3 frames	5 frames	60 images

These figures are approximate and vary with the recording conditions and subjects.

Sufficient space on the memory card is required. Continuous shooting stops when card is full.

○ The number of frames per second may be lower when  (camcorder shake warning) is displayed on the screen.

Auto Exposure Bracketing



Press the PHOTO button.

Three still images in different exposures are recorded to the memory card.



Make sure that there is sufficient space on the memory card.



Recording Panoramic Images (Stitch Assist Mode)

You can shoot a series of overlapping images and merge them into one large panoramic scene using the supplied software (PhotoStitch) on a computer.

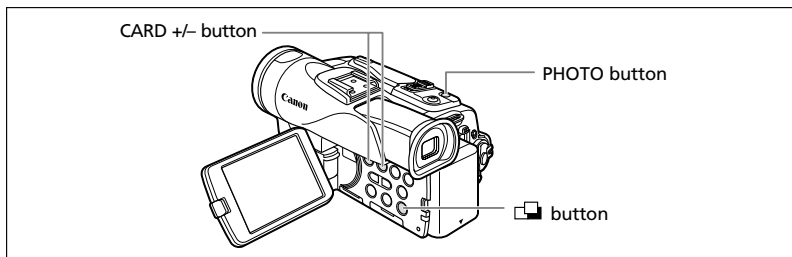

When Recording in Stitch Assist Mode:

PhotoStitch detects the overlapping portion of adjoining images and merges them. Try to include a distinctive item (landmark, etc.) in the overlapping portion.



1. Press the  button.



2. Select the direction with the **CARD +/-** button.

CARD + button: clockwise. CARD – button: counterclockwise.



3. Select the program AE mode and zoom on the subject.

Adjust focus and exposure manually as necessary. Once the sequence has started, you cannot change the program AE mode, exposure, zoom or focus.

4. Press the **PHOTO** button to record the first image.

Direction and number of recorded images appear.

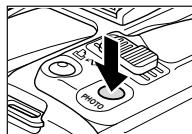

5. Record the second image so that it overlaps a portion of the first image.

- Minor discrepancies in the overlapped area can be corrected with the software.
- You can retake an image by pressing the CARD +/- button to return to the previous image.
- A maximum of 26 images can be recorded.

E



6. Press the button after the last image.

For details on how to merge these images, refer to the *Digital Video Software Instruction Manual*.



- Compose each image so that it overlaps 30 to 50% of the adjoining image. Try to keep the vertical misalignment within 10%.
- Do not include moving subject in the overlapping portion.
- Do not try to stitch images that include both distant and close subjects. They may appear warped or doubled up.

Playing Back a Memory Card

You can display a single image, 6 at one time (index screen  109), or one after another (slide show  109). Use the Card Jump function to quickly locate an image without displaying them one by one ( 110).

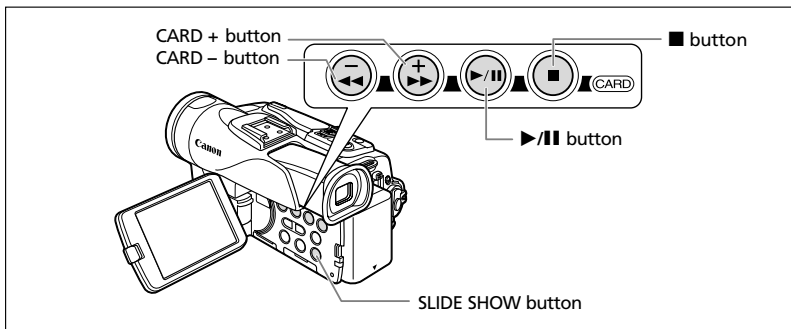

1. Set the camcorder to **CARD PLAY** mode.
2. Press the **CARD +/-** button to move between images.

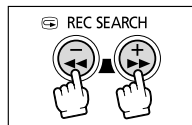

3. To play back a movie, press the **>/||** button.

- The first scene appears as a still image when playback is complete.
- Pressing the **>/||** button during playback pauses the playback. Press the **>/||** button again to restart playback.
- Pressing the **■** button displays the first scene of the movie.
- Press the **CARD +/-** button (or the **REW<</FF>>** button on the wireless controller) for 8x fast forward/fast rewind playback.





- Images not recorded with this camcorder, uploaded from a computer (except the sample images [115]), edited on a computer and images whose file names have been changed may not be played back correctly.
- Do not turn off the camcorder, change the position of the TAPE/CARD switch, disconnect the power source, open the memory card cover or remove the memory card while the card access indicator is flashing. Doing so could result in data damage.

Slide Show



1. Press the SLIDE SHOW button.

Images are played back one after another.

2. Press the SLIDE SHOW button to stop the slide show.



Index Screen



1. Move the zoom lever toward **W**.

Up to 6 images appear.

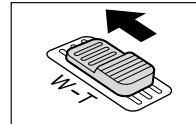

2. Turn the SET dial to select an image.

- Move the  to the image you wish to view.
- You can switch between the index pages by pressing the CARD + or CARD - button.

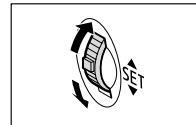

3. Move the zoom lever toward **T**.

The index screen is cancelled and the selected image is displayed.

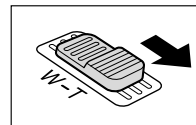

Card Jump Function

You can locate images without displaying them one by one. The number in the upper right of the screen indicates the image number of the current image by the total number of images.



Press and hold the CARD + or CARD – button.

When you release the button, the image of the displayed image number appears.

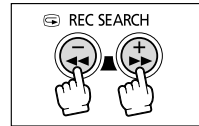

Protecting Images

You can protect important images from accidental erasure when displaying a single image or index screen.

E



If a memory card is formatted, all still images and movies, even protected ones, will be erased permanently.



- The sample images recorded on the supplied SD Memory Card are already protected.
- Movies can only be protected when the first scene is displayed as a still image.



1. Select the image you wish to protect.
2. Press the SET dial to open the FILE OPER. menu.

In CARD CAMERA mode, the menu appears when you press the SET dial while you are reviewing a still image, or when you press the SET dial right after recording.

3. Select [O- PROTECT].
 - "O-" appears and now the image cannot be erased.
 - To cancel the protection, press the SET dial.
4. Select [← RETURN] to close the menu.

Protecting during Index Screen Display



MENU
(38)

CARD OPERATIONS

→ O- PROTECT

1. Move the zoom lever toward W.
 - Up to 6 images appear.
 - Select the image you wish to protect.
2. Open the menu and select [CARD OPERATIONS]. Select [→ O- PROTECT] and press the SET dial.
 - "O-" appears on the image.
 - To cancel the protection, press the SET dial.
3. Close the menu.

Erasing Images

You can erase images singly or all at once.



Be careful when erasing images. Erased images cannot be recovered.



○ Protected images cannot be erased.

○ Movies can only be erased when the first scene is displayed as a still image.

Erasing a Single Image



1. Select the image you wish to erase.
2. Press the SET dial to open the FILE OPER. menu.

In CARD CAMERA mode, the menu appears when you press the SET dial while you are reviewing a still image, or when you press the SET dial right after recording.

3. Select [IMAGE ERASE].

- “ERASE THIS IMAGE?”, [NO] and [YES] appears.
- If an image is protected, [YES] appears in purple.

4. Select [YES].

The image is erased and the previous image appears.

5. Select [← RETURN] to close the menu.

Erasing a Single Image/All Images



MENU
(38)

CARD OPERATIONS

▶ IMAGE ERASE

1. Open the menu and select [CARD OPERATIONS].
2. Select [IMAGE ERASE].
3. Select [SINGLE] or [ALL].

- When erasing a single image: “ERASE THIS IMAGE?” [NO] and [YES] appears. If an image is protected, [YES] appears in purple.
- When erasing all images: “ERASE ALL IMAGES? [EXCEPT FOR IMAGES]”, [NO] and [YES] appears.

4. Select [YES] and close the menu.

- When erasing a single image: The image is erased and the previous image appears. To erase another image, select the image with the CARD +/- button and select [YES].
- When erasing all images: All still images or movies with exception of the protected ones are erased.

Combining Images (Card Mix)

You can produce effects not possible with just a tape with the Card Mix function. Choose one of the sample images provided on the supplied SD Memory Card (such as picture frames, backgrounds and animations) and combine it with the live video recording.

E

Card Chroma Key (CARD CHROMA)

Combines frames with your recordings. The live video recording will appear in place of the blue area of the card mix image.

Mix level adjustment: blue area of the still image.



Card Luminance Key (CARD LUMI.)

Combines illustrations or title with your recordings. The live video recording will appear in place of the light area of the card mix image.

Mix level adjustment: light area of the still image.



Camera Chroma Key (CAM. CHROMA)

Combines backgrounds with your recordings. Record your subject in front of a blue curtain, and the subject not blue will be superimposed on the card mix image.

Mix level adjustment: blue area of the live video recording.



Card Animation (C. ANIMATION)

Combines animations with your recordings. You can choose from 3 types of card animation effects.

- Corner: Animation appears on the upper left and the lower right corner of the screen.
- Straight: Animation appears on the top and bottom of the screen and moves to the right and left.
- Random: Animation moves randomly in the display.

Mix level adjustment: blue area of the card animation image.

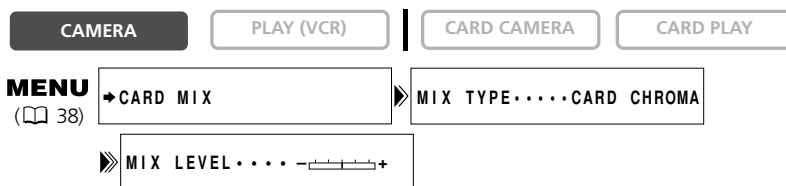
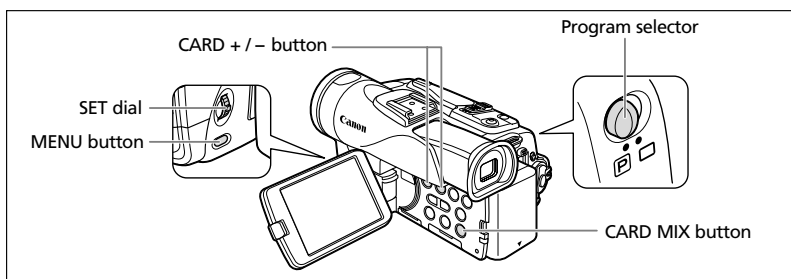
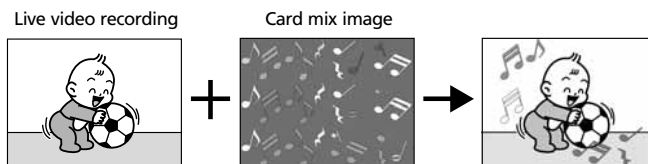

1. Set the program selector to **[P]**.

2. Open the menu and select **[➡CARD MIX]**.

The card mix menu appears.

3. Select the image you wish to combine with the **CARD +/-** button.

4. Select **[MIX TYPE]**.

[CARD CHROMA], [CARD LUMI.], [CAM. CHROMA] and [C. ANIMATION] appears.

5. Select the mix type matching the sample image you have selected.

- The screen shows the combined image.
- When you have selected [C. ANIMATION], select [ANIMAT. TYPE] and select between [CORNER], [STRAIGHT] and [RANDOM].

6. To adjust the mix level, select [MIX LEVEL] and adjust it with the SET dial.

7. Close the menu.

"CARD MIX" flashes.

8. Press the CARD MIX button.

- "CARD MIX" stops flashing.
- The combined image appears.



- Card mix cannot be used when [STILL I. REC] is set to [FINE] or [NORMAL].
- Movies recorded on a memory card cannot be combined with camcorder recordings.
- Additional sample images are provided on the supplied DIGITAL VIDEO SOLUTION DISK. Refer to *Adding Still Images from Your Computer to the Memory Card* in the *Digital Video Software Instruction Manual*.

Sample Images

Following sample images are pre-recorded on the supplied SD Memory Card.

Card Chroma Key

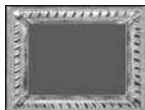
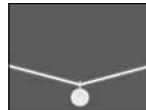

Card Luminance Key

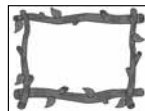

Camera Chroma Key

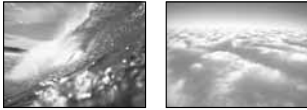

Card Animation

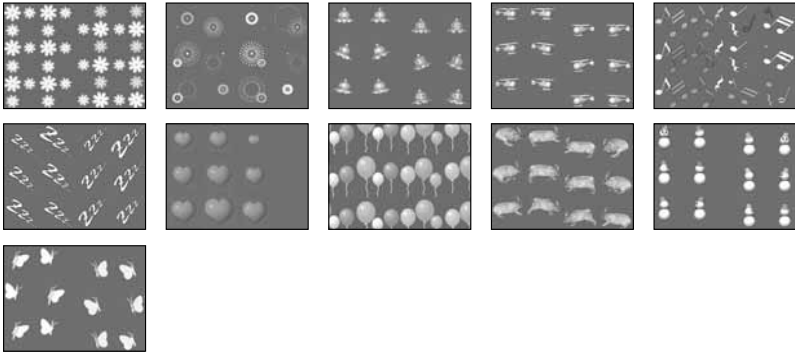

The sample images recorded on the supplied SD Memory Card are intended only for the personal use with this camcorder. Do not use these sample images for other purposes.



If you have mistakenly erased the sample images on the supplied SD Memory Card, they can be downloaded from the homepage <http://www.canondv.com>. For details on how to add the downloaded images to the memory card, refer to *Adding Still Images from Your Computer to the Memory Card* in the *Digital Video Software Instruction Manual*.

PhotoEssentials – Royalty Free Stock Photography

The PhotoEssentials suite of royalty-free images on CD-ROM features premium quality assignment photography and is ideally suited for use in advertising, brochures, reports, multimedia, websites, books, packaging and more.

For more information, please visit their website www.photoessentials.com

Formatting a Memory Card

Format new memory cards, or when you get the message "CARD ERROR". You can also format a memory card to erase all data recorded on it.

E



- Formatting a memory card erases all data, including protected images.
- Images erased by formatting cannot be recovered.
- If you use a memory card other than the supplied one, format it with the camcorder.



1. Open the menu and select [CARD OPERATIONS].

2. Select [FORMAT].

[CANCEL] and [EXECUTE] appears.

3. Select [EXECUTE].

[ALL DATA WILL BE ERASED. FORMAT THIS CARD?], [NO] and [YES] appears.

4. Select [YES] and close the menu.

- Formatting starts.
- Selecting [NO] brings you back to step 3.

Creating a Start-up Image

You can create a start-up image using a still image on the memory card.

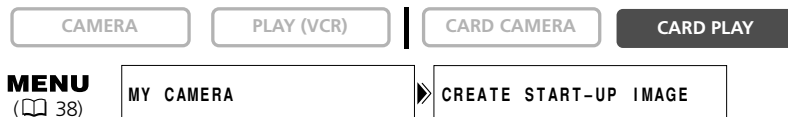

1. Select a still image with the **CARD +/-** buttons.

2. Open the menu and select **[MY CAMERA]**.

3. Select **[CREATE START-UP IMAGE]**.

[SET THIS AS START-UP IMAGE?], [YES] and [NO] appears.

4. Select **[YES]**.

[OVERWRITE MY IMAGE?], [NO] and [YES] appears.

5. Select **[YES]**.

The still image will be saved, and the image that was saved to [MY IMAGE] is erased.







Retain the original data of the still image you have set as the start-up image on your computer or removable disk.

Printing Still Images





You can print still images by connecting the camcorder to a printer with Direct Print function. You can also use the print order settings for direct printing (📄 128). Following printers can be connected to your camcorder:

E

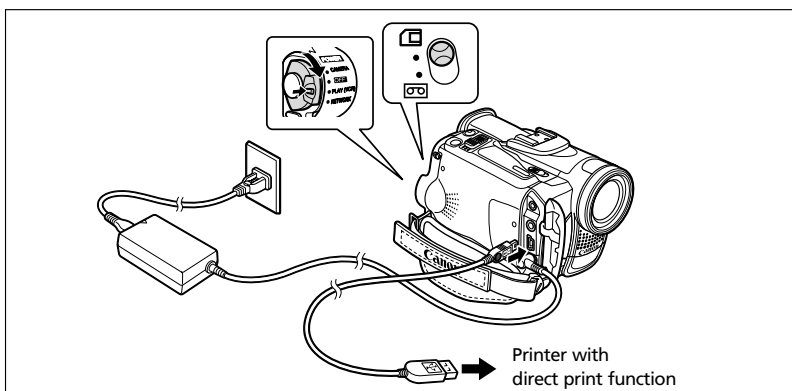



Canon Printers	PictBridge compliant CP Printer	
	Bubble Jet Direct compatible Printer	
	PictBridge compliant Bubble Jet Printer	
	CP-10/CP-100 CP-Printer	
PictBridge compliant non-Canon Printer		

Connecting the Printer to the Camcorder



1. Turn off the camcorder and insert a memory card that contains still images.
2. Turn on the printer.
3. Set the camcorder to CARD PLAY mode.
4. Connect the camcorder to the printer using the cable.
 -  appears and changes to ,  or  when the printer is properly connected to the camcorder. (Does not appear with movies, or still images that cannot be played back with the camcorder.)
 - The  (print/share) button lights up and the current print setting will be displayed for approx. 6 seconds.



- If  continues to flash (for more than 1 minute) or if ,  or  does not appear, the camcorder is not correctly connected to the printer. In such case, disconnect the cable from camcorder and printer, turn off camcorder and printer, turn both back on and reconnect the camcorder to the printer.
- Do not connect the camcorder to a printer when the camcorder is set to NETWORK mode.



- Refer to the instruction manual of each printer for information on which interface cable to use with the camcorder.
The Canon CP-Printers CP-10 and CP-100 are supplied with two direct interface cables. Use the cable with the USB logo on the connector (DIF-100).
- We recommend powering the camcorder from a household power source.
- Refer also to the instruction manual of the respective printer.
- The print setting menu may differ slightly depending on the connected printer.

Printing

CAMERA

PLAY (VCR)

CARD CAMERA

CARD PLAY

1. Select the still image you wish to print with the **CARD +/-** button.

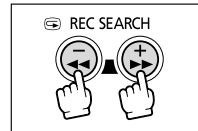

2. Press the (print/share) button.

- Printing starts. The  button flashes and glows steadily when printing is complete.
- If you wish to continue printing, select another still image with the CARD +/- button.

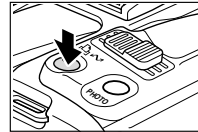

- Observe the following precautions during printing, otherwise printing may not be performed correctly.
 - Do not turn off the camcorder or the printer.
 - Do not change the position of the TAPE/CARD switch.
 - Do not detach the cable.
 - Do not open the memory card cover or remove the memory card.
- Images not recorded with this camcorder, uploaded from a computer, edited on a computer and images whose file names have been changed may not be printed correctly.



○ **Cancel Printing**

Press the SET dial during printing. A confirmation dialog appears. Select [OK] and press the SET dial.

- Canon Bubble Jet Printer: Printing stops even if it is incomplete and the paper is fed through.
- Canon CP-Printer: A print in progress cannot be stopped. Printing stops when the current print is finished and the remaining prints are canceled.

○ **Printing Errors**

If an error occurs during the printing process, an error message appears ( 140).

- Canon Bubble Jet Printer: Select [STOP] or [CONTINUE] and press the SET dial. With most errors, printing resumes automatically after you correct the error. Refer also to the printer manual for details.

- Canon CP-Printer: Select [STOP] or [RESUME] and press the SET dial. (The [RESUME] setting may not appear with some error messages. In that case, select [STOP].) Refer also to the printer manual for details.
- If the error still persists and printing does not restart, follow below procedure:
 1. Disconnect the cable.
 2. Turn the POWER switch of the camcorder to OFF and back to PLAY (VCR).
 3. Reconnect the cable.



○ **When you have finished printing:**

1. Disconnect the cable from the camcorder and printer.
2. Turn off the camcorder.

Selecting the Print Settings

The procedure for selecting the number of copies is common to all printers. Other print setting procedures vary depending on your printer model. Check which icon appears in the upper left corner of the camcorder screen after connecting, and refer to the relevant pages accordingly.



123



124



125

Selecting the Number of Copies

A maximum of 99 copies can be selected for one still image.

1. Press the SET dial.

- The print setting menu appears.
- Depending on the printer, the message “BUSY.” may appear before the camcorder displays the print setting menu.

2. Turn the SET dial to select (COPIES) and press the SET dial.



3. Turn the SET dial to select the number of copies and press the SET dial.



4. Turn the SET dial to select [PRINT] and press the SET dial.

Printing starts. The print setting menu disappears when printing is complete.



Setting the Print Style

PAPER	PAPER SIZE	Available paper sizes vary depending on the printer model.
	PAPER TYPE	PHOTO, FAST PHOTO, DEFAULT
	PAGE LAYOUT	BORDERLESS, BORDERED, DEFAULT, 8-UP
Date print		ON, OFF, DEFAULT
Print effect (Image Optimize)		ON, OFF, VIVID, NR, VIVID+NR, DEFAULT

E



- Print setting options and [DEFAULT] settings vary depending on the printer model. For details, refer to the instruction manual of your printer.
- [8-UP] can be selected when using card size paper (5.3 × 8.6 cm) with CP Printers.
- [BORDERED]: The image area remains relatively unchanged from the recorded image when it is printed. [BORDERLESS]/[8-UP]: The center portion of the recorded image is printed at an enlarged size. The image's top, bottom and sides may be cropped slightly.
- Date print cannot be selected with the CP Printers CP-200 and CP-300.
- [VIVID], [VIVID+NR] and [NR] can be selected with Canon Bubble Jet Printers.
- With CP Printers, make sure to select the paper size of the attached paper cassette.

Paper Settings

1. In the print setting menu, turn the SET dial to select [PAPER] and press the SET dial.



2. Turn the SET dial to select the paper size and press the SET dial.

Select the paper size of the paper set in your printer.



3. Turn the SET dial to select the paper type and press the SET dial.

Select the paper type of the paper set in your printer.



4. Turn the SET dial to select a layout option and press the SET dial.



Direct Printing

Setting the Print Effect (Image Optimize)

This function uses the camcorder's recording information to optimize the image data, yielding high quality prints.

1. In the print setting menu, turn the SET dial to select  (print effect) and press the SET dial.



2. Turn the SET dial to select a setting and press the SET dial.



Including the Date in the Print

1. In the print setting menu, turn the SET dial to select  (date) and press the SET dial.



2. Turn the SET dial to select a date print option and press the SET dial.



Setting the Print Style

Paper Size		CARD #1*, CARD #2*, CARD #3*, LTR, A4 For details on paper type, refer to the Bubble Jet Printer User Guide.
Borders	Borderless	Prints right to the edges of the page.
	Bordered	Prints with a border.

* Recommended paper size



[BORDERED]: The image area remains relatively unchanged from the recorded image when it is printed. [BORDERLESS]: The center portion of the recorded image is printed at an enlarged size. The image's top, bottom and sides may be cropped slightly.

1. In the print setting menu, turn the SET dial to select [STYLE] and press the SET dial.



E

2. Make sure that  (paper) is selected and press the SET dial.



3. Turn the SET dial to select the paper size and press the SET dial.

- Select the paper size of the paper set in your printer.
- Pressing the MENU button brings you back to the print settings menu.



4. Turn the SET dial to select  (borders) and press the SET dial.



5. Turn the SET dial to select a borders option and press the SET dial.

Pressing the MENU button brings you back to the print settings menu.



Setting the Print Style

Image	Standard	Prints 1 still image per page.
	Multiple	Prints 8 copies of the same still image on one page.
Borders	Borderless	Prints right to the edges of the page.
	Bordered	Prints with a border.



- [BORDERED]: The image area remains relatively unchanged from the recorded image when it is printed. [BORDERLESS]/[MULTIPLE]: The center portion of the recorded image is printed at an enlarged size. The image's top, bottom and sides may be cropped slightly.
- [MULTIPLE] can only be selected when printing on card size paper.
- [BORDERS] can only be selected when [IMAGE] is set to [STANDARD].

1. In the print setting menu, turn the SET dial to select [STYLE] and press the SET dial.



Selecting the Image Style

2. Make sure that  (IMAGE) is selected and press the SET dial.



3. Turn the SET dial to select the image style and press the SET dial.

Pressing the MENU button brings you back to the print settings menu.



Selecting the Borders

2. Turn the SET dial to select  (BORDERS) and press the SET dial.



3. Turn the SET dial to select a borders option and press the SET dial.

Pressing the MENU button brings you back to the print settings menu.



Trimming Settings

Set the print style before you start with the trimming settings.

E

1. In the print setting menu, turn the SET dial to select [TRIMMING] and press the SET dial.

The trimming frame appears.



2. Change the size of the trimming frame.

- Move the zoom lever toward **T** to shrink the frame, and toward **W** to enlarge the frame.
- To cancel the trimming settings, move the zoom lever toward **W** until the trimming frame disappears.



3. Move the trimming frame.

- Turn the SET dial to move the frame to the right and left, or up and down. Pressing the SET dial switches between the directions.
- Pressing the MENU button brings you back to the print settings menu.



- About the color of the trimming frame (Canon CP-Printers only):
 - White: No trimming settings.
 - Green: Recommended trimming size. (The trimming frame may not appear in green depending on the image size, paper size or borders settings.)
 - Red: The image is magnified beyond recommended size. The image may print out coarsely.
- The trimming setting applies only to one image.
- The trimming setting is canceled with the following operations:
 - When you turn off the camcorder.
 - When you disconnect the interface cable.
 - When you expand the trimming frame beyond its maximum size.

Direct Printing

Printing with Print Order Settings

You can select still images for printing and set the number of copies. These print order settings are compatible with the Digital Print Order Format (DPOF) standards and can be used for printing on DPOF compatible printers (☞ 119). A maximum of 200 still images can be selected.

Selecting Still Images for Printing (Print Order)



1. Select the still image you wish to print.
2. Press the SET dial to open the FILE OPER. menu.
3. Select [🖨️ PRINT ORDR].
4. Select the number of copies.
 - “🖨️” appears on the image.
 - To cancel the print order, set the number of copies to 0.
5. Select [← RETURN] to close the menu.

Selecting in Index Screen Display



1. Move the zoom lever toward **W**.
 - Up to 6 images appear.
 - Select the image you wish to print.
2. Open the menu and select [CARD OPERATIONS]. Select [➡️🖨️ PRINT ORDER].
3. Press the SET dial and set the number of copies with the SET dial.
 - “🖨️” appears on the image.
 - To cancel the print order, set the number of copies to 0.
4. Close the menu.

Erasing All Print Orders



E

1. Open the menu and select [CARD OPERATIONS].

2. Select [PRINT ORDERS ALL ERASE].

"ERASE ALL PRINT ORDERS?", [NO] and [YES] appears.

3. Select [YES].

All "PRINT" disappear.

4. Close the menu.

Printing



1. Connect the printer to the camcorder (119).

2. Open the menu and select [PRINT].

- The print setting menu appears.
- "SET PRINT ORDER" appears, when you connect a printer with direct print function and select [PRINT] without having set the print order.

3. Make sure that [PRINT] is selected and press the SET dial.

Printing starts. The print setting menu disappears when printing is complete.



○ Depending on the connected printer, you can select style or paper settings before step 3.

○ **Cancel Printing/Printing Errors (120)**



○ **Restarting Printing**

Open the CARD PLAY menu and select [PRINT]. Select [RESUME] in the print setting menu and press the SET dial. The remaining images will be printed.

Printing cannot be restarted in the following cases:

- When you change the print order settings.
- When you delete a still image with print order settings.

Connecting to a Computer Using a USB Cable

You can download images from the memory card to a computer using the supplied software and USB cable. For details, refer to the *Digital Video Software Instruction Manual*. Users of Windows OS can transfer images by simply pressing the  (print/share) button ( 131).

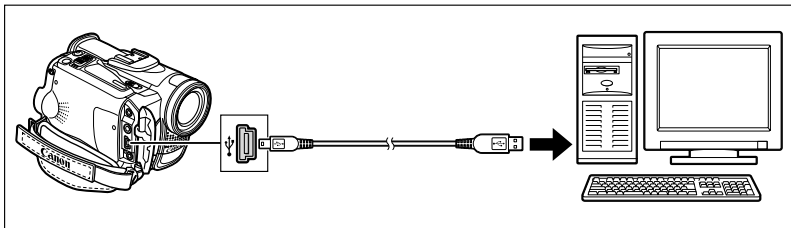

- Do not disconnect the USB cable, open the memory card cover, remove the memory card, change the position of the TAPE/CARD switch or turn off the camcorder and computer while data is being transferred to the computer (while the camcorder's card access indicator is flashing). Doing so may damage the memory card's data.
- Operation may not work correctly depending on the software and the specifications/settings of your computer.
- The image files on your memory card and the image files saved on the hard disk drive of your computer are valuable, original data files. If you wish to use image files on your computer, make copies of them first, and use the copied file, retaining the original.
- Make sure that camcorder and computer are not connected with a DV cable before connecting the camcorder to the computer using the USB cable. Otherwise, the computer may not operate properly.







- We recommend powering the camcorder from a household power source while it is connected to the computer.
- Refer also to the computer instruction manual.
- Images recorded on a tape cannot be transferred to a computer via USB interface.
- Users of Windows XP and Mac OS X:
Your camcorder is equipped with the standard Picture Transfer Protocol (PTP) allowing you to download still images (JPEG only) by simply connecting the camcorder to a computer via USB cable without installing the software from the DIGITAL VIDEO SOLUTION DISK.

Direct Transfer Windows OS Only

You can transfer images to the computer with the  (print/share) button.

E

 ALL IMAGES	Transfers all images to the computer.
 NEW IMAGES	Transfers only those images that have not yet been transferred to the computer.
 TRANSFER ORDERS	Transfers images with transfer orders to the computer.
 SELECT & TRANSFER	Allows you to select an image and transfers the selected image to the computer.
 WALLPAPER	Allows you to select a still image and transfers the selected image to the computer as wallpaper.

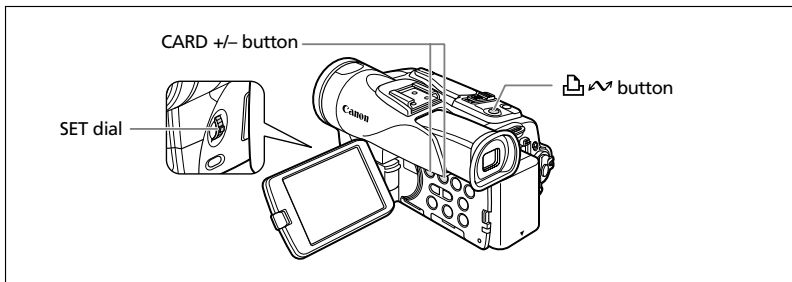

Preparations

The first time you connect the camcorder to the computer, you need to install the software and set the auto-launch setting.

1. Install the supplied Digital Video Software.

See *Installing the Software* in the *Digital Video Software Instruction Manual*.

2. Connect the camcorder to the computer using the USB cable.

See *Connecting the Camcorder to a Computer* in the *Digital Video Software Instruction Manual*.

3. Set the auto-launch setting.

- Follow the steps 1 to 3 in *Starting ZoomBrowser EX* in the *Digital Video Software Instruction Manual*.
- The direct transfer menu appears on the camcorder screen and the  button lights up.



From the second time on, you only need to connect the camcorder to the computer to transfer images.

Transferring All Images, New Images or Images with Transfer Orders

To transfer images with transfer order, you need to set the transfer orders (📄 134).



1. Turn the SET dial to select [📄 ALL IMAGES], [📄 NEW IMAGES] or [📄 TRANSFER ORDERS].

2. Press the 📄 button.

- The images are transferred to the computer and displayed in the Main Window of ZoomBrowser EX.
- The camcorder displays the transfer menu when transfer is complete.



Transferring a Selected Image



1. Turn the SET dial to select [📄 SELECT & TRANSFER].

2. Press the 📄 button.

3. Select the image you wish to transfer with the CARD+/- button.

4. Press the 📄 button.

- The selected image is transferred to the computer and displayed in the Main Window of ZoomBrowser EX.
- Pressing the MENU button brings you back to the transfer menu.
- To continue transferring, select another image with the CARD+/- button.



Transferring a Still Image as Wallpaper



1. Turn the SET dial to select [📄 WALLPAPER].

2. Press the 📄 button.



3. Select the still image you wish to transfer as wallpaper with the CARD +/- button.

4. Press the 📄 button.

- The selected image is transferred to the computer and displayed on the desktop.
- Pressing the MENU button brings you back to the transfer menu.





- You can press the SET dial in place of the  button. With [ALL IMAGES], [NEW IMAGES] or [TRANSFER ORDERS], a confirmation message appears. Turn the SET dial to select [OK] and press the SET dial.
- To cancel transfer, turn the SET dial to select [CANCEL] and press the SET dial, or press the MENU button.
- Only still images in JPEG format and movies in Motion JPEG format can be transferred.
- When printing with the  button, the camcorder retains the transfer setting even if you turn it off or change the position of the TAPE/CARD switch. When you have selected [SELECT & TRANSFER] or [WALLPAPER], the screen to select a still image appears. Press the MENU button to display the direct transfer menu.

E

Selecting Images for Transfer (Transfer Order)

You can select images for transfer to the computer. These transfer settings are compatible with the Digital Print Order Format (DPOF) standards. A maximum of 200 images can be selected.



1. Select the image you wish to transfer.
2. Press the SET dial to open the FILE OPER. menu.
3. Select [⇐ TRANS.ORDER] and press the SET dial.
 - “⇐” appears on the image.
 - To cancel the transfer order, press the SET dial again.
4. Select [← RETURN] to close the menu.

Selecting in Index Screen Display



1. Move the zoom lever toward W.
Up to 6 images appear.
2. Open the menu and select [CARD OPERATIONS]. Select [⇒ ⇐ TRANSFER ORDER].
3. Press the SET dial on the image you wish to transfer.
 - “⇐” appears on the image.
 - To cancel the transfer order, press the SET dial again.
4. Close the menu.

Erasing All Transfer Orders



1. Open the menu and select [CARD OPERATIONS].
2. SELECT [⇐ TRANS.ORDERS ALL ERASE].
“ERASE ALL ⇐ TRANSFER ORDERS?”, [NO] and [YES] appears.
3. Select [YES].
All “⇐” disappear.

4. Close the menu.

About the NETWORK Mode

The NETWORK mode is for use with DV Messenger version 2 (Windows XP only). Set the camcorder to NETWORK mode and connect it to the computer using a DV (IEEE1394) cable.

For details on DV Messenger version 2, refer to the *DV Network Software Instruction Manual*.

E

Connection

1. Install DV Messenger.
2. Connect the power adapter to the camcorder.
3. Press the small button below the POWER switch and turn the POWER switch to NETWORK.

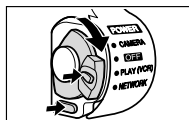

4. Connect the camcorder to the computer using a DV cable.

- "NETWORK MODE" appears on the camcorder screen.
- When you have connected the camcorder to the computer, start DV Messenger. You can now operate the camcorder from the computer using DV Messenger.



- When DV Messenger is started and set up for communication, the video picture appears on the computer screen.
- In NETWORK mode, the camcorder can only be operated from the computer, except for the following functions:
 - When the DV Messenger [CAMERA] control panel is displayed: Zoom and focus (when DV Messenger set to autofocus)
 - When the DV Messenger [VCR] control panel is displayed: Volume adjustment of the built-in speaker
- The image stabilizer and digital zoom cannot be used with DV Messenger.
- The camcorder cannot be operated with the wireless controller.

Screen Displays

Hiding the Displays on the LCD Screen

You can hide the displays on the LCD screen to have a clear screen for playback.



Open the menu and select **[DISPLAY SETUP/ [Mute icon]]**. Select **[DISPLAYS]**, set it to **[OFF <PLAYBK>]** and close the menu.

- Warning messages still appear, and the data code appears if turned on.
- Tape operation displays appear for 2 seconds.
- Displays cannot be hidden on the index screen.

Hiding/Showing the Displays on the TV Screen

When you connect a TV for recording, you can select to show the camcorder displays on the TV screen. For playback, you can hide the camcorder displays on the TV screen.

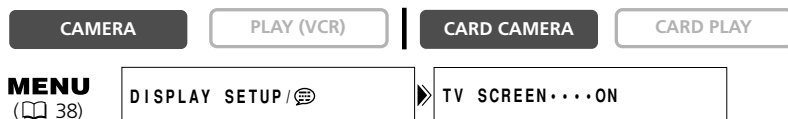

Open the menu and select **[DISPLAY SETUP/ [Mute icon]]**. Select **[TV SCREEN]**, set it to **[OFF]** and close the menu.

The displays disappear from the TV screen.



Open the menu and select **[DISPLAY SETUP/ [Mute icon]]**. Select **[TV SCREEN]**, set it to **[ON]** and close the menu.

The displays appear on the TV screen.

Screen Displays during Recording/Playback

CAMERA Mode

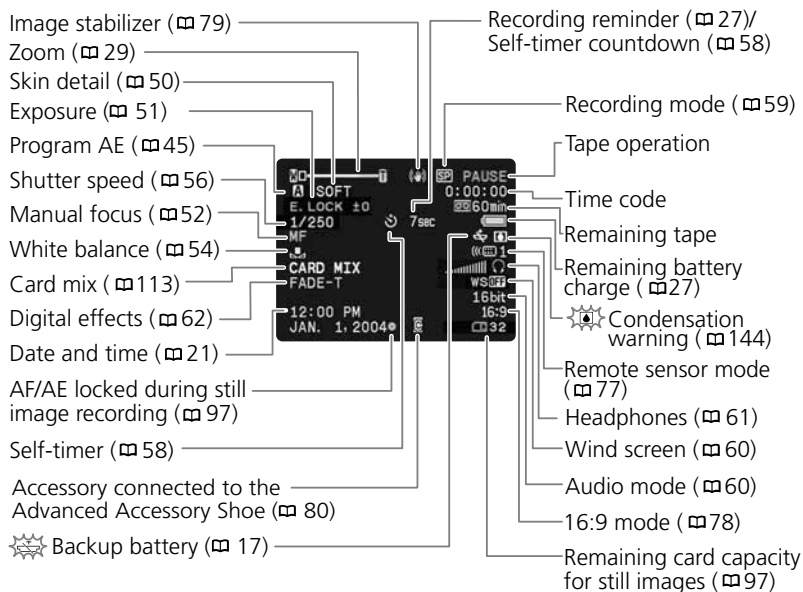

E

PLAY (VCR) Mode

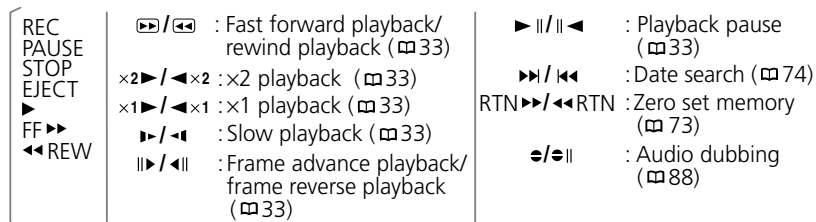

Additional
Information

CARD CAMERA Mode

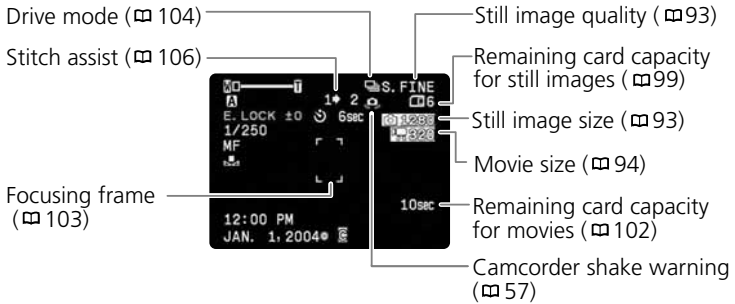

CARD PLAY Mode





List of Messages

Message	Explanation	
SET THE TIME ZONE, DATE AND TIME	You have not set the time zone, date and time. This message appears each time you turn the power on until you set the time zone, date and time.	21
CHANGE THE BATTERY PACK	Battery pack is exhausted. Replace or charge the battery pack.	13
THE TAPE IS SET FOR ERASURE PREVENTION	Cassette is protected. Replace the cassette or change the position of the protect switch.	146
REMOVE THE CASSETTE	Camcorder stopped operating to protect the tape. Unload and reload the cassette.	16
CHECK THE DV INPUT	DV cable is not connected, or the connected digital device is turned off.	85
CONDENSATION HAS BEEN DETECTED	Condensation has been detected in the camcorder.	144
TAPE END	Tape reached the end. Rewind the tape or replace the cassette.	–
CHECK THE CASSETTE [REC MODE]	You attempted to perform audio dubbing on a tape recorded in a mode other than the SP mode.	88
CHECK THE CASSETTE [AUDIO MODE]	You attempted to perform audio dubbing on a tape recorded in 16-bit or 12-bit 4-channel sound.	88
CHECK THE CASSETTE [BLANK]	You attempted to perform audio dubbing on a tape with a blank section.	88
HEADS DIRTY, USE CLEANING CASSETTE	Video heads are dirty. Clean the video heads.	143
COPYRIGHT PROTECTED PLAYBACK IS RESTRICTED	You attempted to play back a copyright protected tape.	85
COPYRIGHT PROTECTED DUBBING RESTRICTED	You attempted to dub a copyright protected tape. May also appear when an anomalous signal is received during analog line-in recording, or during analog-digital conversion of a copyright protected tape.	85

E



Memory Card Related Messages



Message	Explanation	
NO CARD	Memory card not is inserted into the camcorder.	92
THE CARD IS SET FOR ERASURE PREVENTION	SD Memory Card is set for erasure prevention. Replace the card or change the position of the protect switch.	92
NO IMAGES	No images are recorded on the memory card.	–
CARD ERROR	A memory card error occurred. The camcorder cannot record or play back the image. The error may be temporary. If the message disappears after 4 seconds and  flashes red, turn the camcorder off, remove the card and reinsert the card. If  changes to green, you can continue recording/playback.	–
CARD FULL	No remaining capacity on the memory card. Replace with another card or erase images.	–
NAMING ERROR	File or folder number has reached the maximum value.	95

Additional
Information

Message	Explanation	
UNIDENTIFIABLE IMAGE	Image is recorded in a not compatible JPEG format or another format not compatible with the camcorder, or the image file is corrupted.	-
 TRANSFER ORDER ERROR	You attempted to set more than 200 transfer orders.	134
CANNOT TRANSFER!	You attempted to transfer a movie file as wallpaper.	132
THIS IMAGE CANNOT BE RECORDED	Some analog images cannot be recorded on the memory card depending on the signal.	-
THIS IMAGE CANNOT BE USED AS START-UP IMAGE	You attempted to use an image recorded with another camcorder, recorded in a format not compatible with this camcorder, or that has been edited on a computer.	118
TOO MANY STILL IMAGES DISCONNECT USB CABLE	Disconnect the USB cable, decrease the number of still images on the memory card to less than 1800. If a dialog appeared on the computer screen, close it. Reconnect the USB cable.	-

Direct Print Related Messages

Message	Explanation
PAPER ERROR	There is a problem with the paper. Wrong paper size is inserted, or the ink cannot be used with the selected paper.
NO PAPER	Paper is not correctly inserted or there is no paper.
PAPER JAM	The paper jammed during printing.
PAPER HAS BEEN CHANGED	Paper size has been changed between print setting and start of printing.
MEDIA TYPE ERROR	You attempted to use a paper size/type that is not supported by the printer.
INCOMPATIBLE PAPER SIZE	You attempted to print on paper that cannot be used with the camcorder.
INK ERROR	There is a problem with the ink.
NO INK	The ink cartridge is not inserted or is out of ink.
LOW INK LEVEL	The ink cartridge needs to be replaced soon.
INK CASSETTE ERROR	There is a problem with the ink cassette.
PAPER AND INK DO NOT MATCH	The ink cannot be used with the selected paper type.
WASTE TANK FULL	Waste tank is full. Refer to the instruction manual of your printer.
FILE ERROR	You attempted to print an image that was made with another camcorder, has a different format, or was edited on a computer.
CANNOT PRINT!	You attempted to print an image that was made with another camcorder, has a different format, or was edited on a computer.
COULD NOT PRINT X IMAGES	You attempted to use the print order settings to print X images that were made with another camcorder, have a different format or were edited on a computer.
SET  PRINT ORDER	You attempted to print an image from the CARD PLAY menu [ PRINT] without having set the print order.
 PRINT ORDER ERROR	You attempted to set more than 200 still images in the print order.

Message	Explanation
CANNOT TRIM	You attempted to trim an image with an image size of 160 × 120, or an image not recorded in the 4:3 ratio.
READJUST TRIMMING	You changed the print style after you set the trimming settings.
PRINTER ERROR	Cancel printing. Turn off the printer and turn it back on. Check the printer status.
PRINT ERROR	Cancel printing and turn off the printer. After a while, turn the printer back on and check its status.
HARDWARE ERROR	Cancel printing. Turn off the printer and turn it back on. Check the printer status.
RECHARGE THE PRINTER BATTERY	The printer battery is depleted.
COMMUNICATION ERROR	The printer is experiencing a data transmission error. Cancel printing, disconnect the USB cable and turn off the printer. After a while, turn the printer back on and reconnect the USB cable. When you are printing using the  button, check the print settings. Or, you attempted to print from a memory card that contains a large number of images. Reduce the number of images.
CHECK PRINT SETTINGS	The print setting cannot be used for printing with the  button.
PRINTER IN USE	The printer is in use. Check the printer status.
PRINTER WARMING UP	Printer is warming up. If the message does not disappear after a few seconds, check the printer status.
PAPER LEVER ERROR	Paper lever error occurred. Adjust the paper selection lever to the proper position.
PRINTER COVER OPEN	Close the printer cover securely.
NO PRINTHEAD	No print head is installed in the printer or print head is defect. Refer to the instruction manual of your printer.

Maintenance/Others

Camcorder Handling Precautions

- Do not carry the camcorder by the LCD panel or viewfinder.
- Do not leave the camcorder in places subject to high temperatures, such as a sun-heated car, and high humidity.
- Do not use the camcorder in places subject to magnetic or electric fields such as near the TV transmitters or portable communication devices.
- Do not point the lens or viewfinder at strong light sources. Do not leave the camcorder pointed at a bright subject.
- Do not use the camcorder in dusty or sandy places. Dust or sand getting inside the cassette or camcorder may cause damage. Dust and sand can also damage the lens. Attach the lens cap after use.
- The camcorder is not waterproof. Water, mud or salt getting inside the cassette or camcorder may cause damage.
- Be careful of heat generated by lighting equipment.
- Do not disassemble the camcorder. If the camcorder does not function properly, consult qualified service personnel.
- Handle the camcorder with care. Do not subject the camcorder to shocks or vibration as this may cause damage.
- Avoid sudden changes in temperature. Moving the camcorder rapidly between hot and cold temperatures may cause condensation to form on its internal surfaces (☞ 144).

Storage

- If you do not intend to use the camcorder for a long time, store it in a place free of dust, in low humidity, and at temperatures not higher than 86 °F (30 °C).
- After storage, check the functions of your camcorder to make sure that the camcorder is still working properly.

Cleaning

Camcorder Body and Lens

- Use a soft, dry cloth to clean the camcorder body and lens. Never use chemically treated cloth or volatile solvents such as paint thinner.

LCD Screen

- Clean the LCD screen using a commercially available cleaning cloth for glasses.
- Condensation may form on the surface of the screen when the temperature changes suddenly. Wipe it with a soft dry cloth.

- At cold temperatures, the screen may be darker than usual. This is not a malfunction. The screen returns to normal when the camcorder warms up.

Viewfinder

- Move the viewfinder upward. Remove the protect cover and clean the glass with a cotton swab. Reattach the protect cover when finished.
- Be careful not to scratch the glass when cleaning.

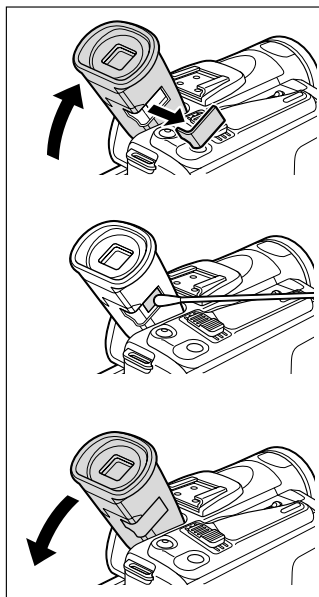

E

Video Heads

- When the message "HEADS DIRTY, USE CLEANING CASSETTE" appears, or when the playback picture becomes distorted, the video heads need to be cleaned.
- To maintain the best picture quality, we recommend cleaning the video heads frequently with the Canon DVM-CL Digital Video Head Cleaning Cassette or a commercially available dry cleaning cassette.
- Tapes already recorded with dirty video heads may not be played back correctly even when you clean the video heads.
- Do not use wet type cleaning cassettes as this may damage the camcorder.



Condensation

Moving the camcorder rapidly between hot and cold temperature may cause condensation (water droplets) to form on its internal surfaces. Stop using the camcorder if condensation is detected. Continued use may damage the camcorder.

Condensation may form in the following cases:

When the camcorder is moved from an air-conditioned room to a warm, humid place

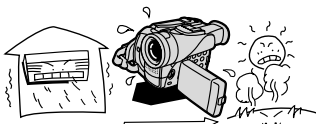

When the camcorder is moved from a cold place to a warm room



When the camcorder is left in a humid room

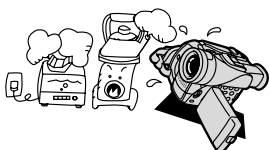



When a cold room is heated rapidly



How to avoid condensation:

- Unload the cassette, place the camcorder in an airtight plastic bag and let it adjust to temperature changes slowly before removing it from the bag.

When condensation is detected:

- The camcorder stops operating and the warning message "CONDENSATION HAS BEEN DETECTED" appears for approx. 4 seconds and  starts flashing.
- If a cassette is loaded, the warning message "REMOVE THE CASSETTE" appears and  starts flashing. Remove the cassette immediately and leave the cassette compartment open. Leaving the cassette in the camcorder may damage the tape.
- A cassette cannot be loaded when condensation is detected.

Resuming use:

- It takes about 1 hour until the water droplets evaporate. After the condensation warning stops flashing, wait for 1 more hour before resuming use.

Battery Pack Handling Precautions

DANGER!

Treat the battery pack with care.

- Keep it away from fire (or it might explode).
- Do not expose the battery pack to temperature higher than 140 °F (60 °C). Do not leave it near a heater or inside a car in hot weather.
- Do not try to disassemble or modify it.
- Do not drop or knock it.
- Do not get it wet.

E

- Charged battery packs continue to discharge naturally. Therefore, charge them on the day of use, or the day before, to ensure a full charge.
- Attach the terminal cover whenever a battery pack is not in use. Contact to metallic objects may cause a short circuit and damage the battery pack.
- Dirty terminals may cause a poor contact between the battery pack and the camcorder. Wipe the terminals with a soft cloth.
- Since storing a charged battery pack for a long time (about 1 year) can shorten its lifecycle or affect performance, we recommend to discharge the battery pack fully and to store it in a dry place at temperatures no higher than 86 °F (30 °C). If you do not use the battery pack for long periods, charge and discharge it fully at least once a year. If you have more than 1 battery pack, perform these precautions at the same time for all battery packs.
- Although the battery pack's operating temperature range is from 32 °F to 104 °F (0 °C to 40 °C), the optimal range is from 50 °F to 86 °F (10 °C to 30 °C). At cold temperatures, performance will temporarily decline. Warm it in your pocket before use.
- Replace the battery pack if the usable time after full charge diminishes substantially at normal temperatures.

About the battery terminal cover

The battery terminal cover has a [□]-shaped hole. This is useful when you wish to differentiate between charged and uncharged battery packs. For example, with charged battery packs, attach the terminal cover so that the [□]-shaped hole shows the blue label.

Back side of the battery pack

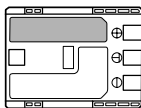

Terminal cover attached
Charged

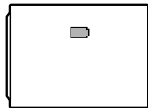

Uncharged

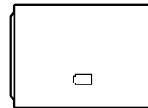

Additional
Information

Cassette Handling Precautions

- Rewind tapes after use. If the tape becomes slack and damaged, it may cause picture and sound distortion.
- Return cassettes in the case and store them upright.
- Do not leave the cassette in the camcorder after use.
- Do not use spliced tapes or nonstandard cassettes as they may damage the camcorder.
- Do not use tapes that have been jammed as video heads may become dirty.
- Do not insert anything into the small holes of the cassette, or cover them with cellophane tape.
- Handle cassettes with care. Do not drop or subject them to severe impact as this may damage the cassettes.
- Rewind tapes from time to time if they are stored for a long time.
- With cassettes equipped with a memory function, metal plated terminals may become dirty with use. Clean the terminals with a cotton swab after about 10 times of loading/unloading. The memory function is not supported by the camcorder.

Protecting Tapes from Accidental Erasure

To protect your recordings from accidental erasure, slide the tab on the cassette to the left. (This switch position is usually labeled SAVE or ERASE OFF.)

If you load a protected cassette in CAMERA mode, the message "THE TAPE IS SET FOR ERASURE PREVENTION" appears for approx. 4

seconds and  starts flashing. If you wish to record on that cassette, slide the tab back to the right.

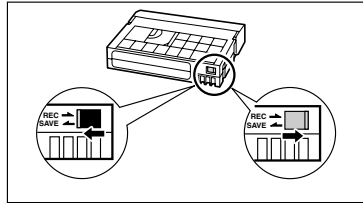

Memory Card Handling Precautions

- Format new memory cards with the camcorder. Memory cards formatted with other devices such as a computer may not operate correctly.
- We recommend saving backups of memory card images on your computer's hard drive or other external memory device. Image data may be corrupted or lost due to memory card defects or exposure to static electricity. Canon Inc. makes no warranties for corrupted or lost data.
- Do not turn off the camcorder, disconnect the power source, open the memory card cover or remove the memory card while the card access indicator is flashing.
- Do not use memory cards in places subject to strong magnetic fields.
- Do not leave memory cards in places subject to high humidity and high temperature.
- Do not disassemble memory cards.
- Do not bend, drop, or subject memory cards to shocks and do not expose them to water.

- Moving a memory card rapidly between hot and cold temperatures may cause condensation to form on its external and internal surfaces. If condensation forms on the card, put it aside until the droplets have evaporated completely.
- Do not touch or expose the terminals to dust or dirt.
- Check the direction before inserting the memory card. Forcing a memory card backwards into the slot may damage the memory card or the camcorder.
- Do not remove the label from the memory card, or affix other labels on the memory card.

E

Using the Camcorder Abroad

Power Sources

You can use the compact power adapter to operate the camcorder and to charge battery packs in any country with power supply between 100 and 240 V AC, 50/60 Hz. Consult the Canon Service Center for information on plug adapters for overseas use.

Playback on a TV Screen

You can only play back your recordings on TVs with NTSC system. The NTSC system is used in the following countries/areas:

American Samoa, Antigua, Aruba, Bahamas, Barbados, Bermuda, Bolivia, Canada, Chile, Columbia, Costa Rica, Cuba, Ecuador, El Salvador, Guam, Guatemala, Greenland, Haiti, Honduras, Jamaica, Japan, Korea, Mexico, Micronesia, Myanmar, Nicaragua, Panama, Peru, Philippines, Puerto Rico, Saint Kitts and Nevis, Saint Lucia, Saint Vincent and the Grenadines, Surinam, Taiwan, Trinidad and Tobago, USA, Venezuela, Virgin Islands.



Troubleshooting

If you have a problem with your camcorder, refer to this checklist. Consult your dealer or a Canon Service Center if the problem persists.

Power Source

Problem	Cause	Solution	
Camcorder will not turn on.	Battery pack is exhausted.	Replace or charge the battery pack.	13
	Battery pack is not correctly attached.	Attach the battery pack correctly.	13
The camcorder switches off by itself.	Battery pack is exhausted.	Replace or charge the battery pack.	13
	Power save function has been activated.	Turn on the camcorder.	25
Cassette compartment will not open.	Battery pack is exhausted.	Replace or charge the battery pack.	13
	Cassette compartment cover is not fully open.	Open the cassette compartment cover fully.	16
Cassette compartment stopped during loading/unloading.	Battery pack is exhausted.	Replace or charge the battery pack.	13
	The camcorder malfunctions.	Consult a Canon Service Center.	–
LCD/viewfinder switches on and off.	Battery pack is exhausted.	Replace or charge the battery pack.	13
Battery pack will not charge.	Battery packs will not charge outside the temperature range of 32 °F and 104 °F (0 °C and 40 °C).	Charge the battery pack in temperatures between 32 °F and 104 °F (0 °C and 40 °C).	–
	Battery packs become hot with use and may not charge.	Wait until the battery pack temperature is below 104 °F (40 °C) and retry charging.	–
	The battery pack is damaged.	Use a different battery pack.	–

Recording/Playback

Buttons will not work.	Camcorder is not turned on.	Turn on the camcorder.	24
	Cassette is not loaded.	Load a cassette.	16
 flashes on the screen.	Cassette is not loaded.	Load a cassette.	16
 flashes on the screen.	Battery pack is exhausted.	Replace or charge the battery pack.	13
 flashes on the screen.	Condensation is detected.	See reference page.	144
“REMOVE THE CASSETTE” appears on the screen.	Camcorder stopped operating to protect the tape.	Unload and reload the cassette.	16
The wireless controller will not work.	Camcorder and wireless controller are not set to the same remote sensor mode.	Change the remote sensor modes.	77
	Batteries of the wireless controller are exhausted.	Replace the batteries.	20

Recording

Problem	Cause	Solution	☐
Image will not appear on the screen.	Camcorder is not set to CAMERA mode.	Set the camcorder to CAMERA mode.	24
“SET THE TIME ZONE, DATE AND TIME” appears on the screen.	Time zone, date and time are not set, or the backup battery is exhausted.	Set the time zone, date and time, or replace the backup battery and reset the date and time.	21
Pressing the start/stop button will not start recording.	Camcorder is turned off.	Turn on the power.	24
	Cassette is not loaded.	Load a cassette.	16
	Tape reached the end (END flashes on the screen).	Rewind the tape or replace the cassette.	16
	Cassette is protected (protect flashes on the screen).	Replace the tape or change the position of the protect switch.	146
	Camcorder is set to a mode other than the CAMERA mode.	Set the camcorder to CAMERA mode.	24
Camcorder will not focus.	Autofocus does not work on that subject.	Focus manually.	52
	Viewfinder is not adjusted.	Adjust the viewfinder with the dioptic adjustment lever.	18
	Lens is dirty.	Clean the lens.	142
A vertical light bar appears on the screen.	Bright light in a dark scene may cause a vertical light bar (smear) to appear. This is not a malfunction.	---	--
Sound is distorted or recorded in a lower volume than the actual volume.	When recording near loud sound (such as fireworks, drums or concerts), sound may become distorted or may not be recorded in the actual sound level. This is not a malfunction.	---	--
Viewfinder picture is blurred.	Viewfinder is not adjusted.	Adjust the viewfinder with the dioptic adjustment lever.	18

E

Playback

Problem	Cause	Solution	
Pressing the playback button does not start playback.	Camcorder is turned off, or is not set to PLAY (VCR) mode.	Set the camcorder to PLAY (VCR) mode.	32
	Cassette is not loaded.	Load a cassette.	16
	Tape reached the end (END flashes on the screen).	Rewind the tape.	32
Image will not appear on the TV screen.	[AV/PHONES $\left(\begin{smallmatrix} \text{AV} \\ \text{PHONES} \end{smallmatrix}\right)$] is set to [PHONES $\left(\begin{smallmatrix} \text{AV} \\ \text{PHONES} \end{smallmatrix}\right)$] in the menu.	Set [AV/PHONES $\left(\begin{smallmatrix} \text{AV} \\ \text{PHONES} \end{smallmatrix}\right)$] to [AV] in the menu.	35
	[AV \Rightarrow DV OUT] is set to [ON].	Set [AV \Rightarrow DV OUT] to [OFF].	87
Tape is running, but image will not appear on the TV screen.	TV/VIDEO selector on the TV is not set to VIDEO.	Set the selector to VIDEO.	35
	Video heads are dirty.	Clean the video heads.	143
	You attempted to play back or dub copyright protected tape.	Stop playback/dubbing.	-
No sound from the built-in speaker.	Speaker volume is turned off.	Adjust the volume with the SET dial.	34

Memory Card Operation

Memory card cannot be inserted.	Memory card was not facing the correct direction.	Turn the memory card over and reinsert it.	92
Memory card cannot be recorded.	Memory card is full.	Replace the memory card or erase images.	92
	Memory card is not formatted.	Format the memory card.	117
	Memory card is not inserted.	Insert a memory card.	92
	File number reached maximum value.	Set [FILE NUMBERS] to [RESET] and insert a new memory card.	95
	SD Memory Card is protected.	Change the position of the protect switch.	92
Memory card cannot be played back.	Camcorder is not set to CARD PLAY mode.	Set the camcorder to CARD PLAY mode.	108
	Memory card is not inserted.	Insert a memory card.	92
Image cannot be erased.	Image is protected.	Cancel the protection.	111
	SD memory card is protected.	Change the position of the protect switch.	92
\square flashes red.	Card error occurred.	Turn off the camcorder. Remove and reinsert the memory card. Format the memory card if flashing persists.	117

Printing

The printer is not operating even though camcorder and printer are correctly connected.	The camcorder is set to NETWORK mode.	1. Set the camcorder to CARD PLAY mode. 2. Disconnect and reconnect the USB cable. 3. Turn off the printer and turn it back on.	-
---	---------------------------------------	---	---

System Diagram (Availability differs from area to area)

E

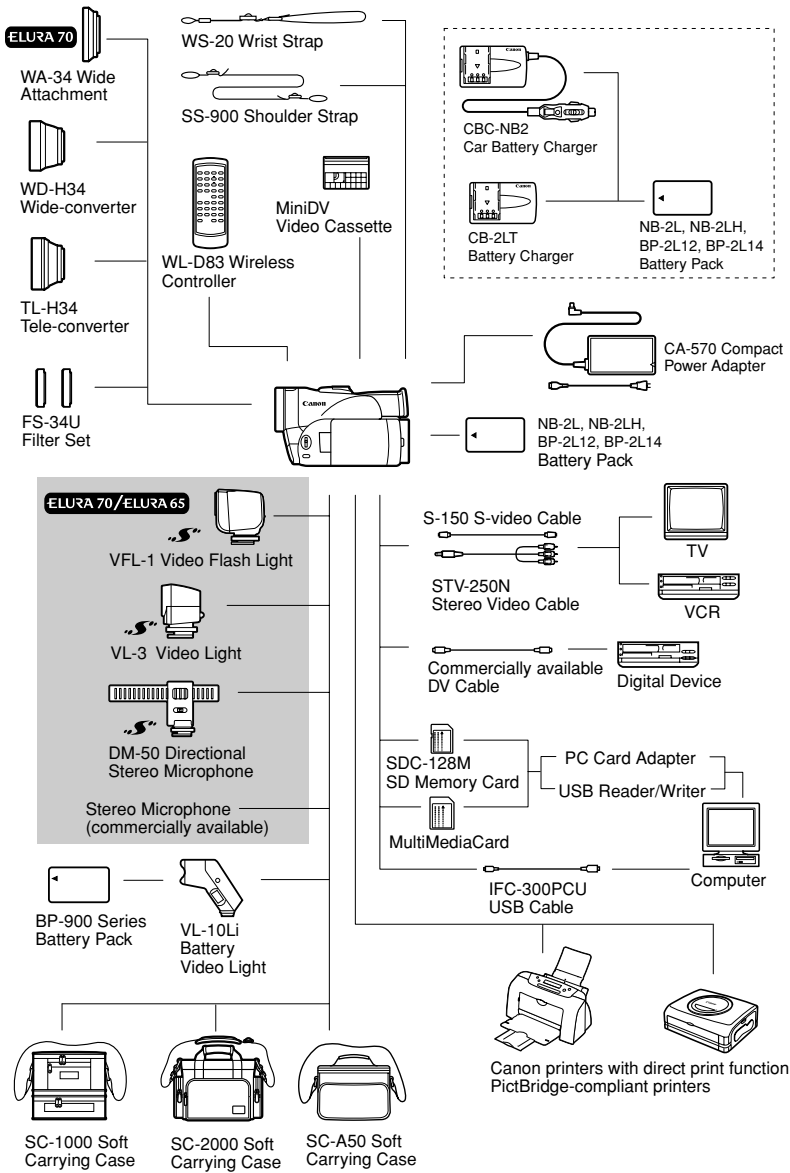

Additional Information

Optional Accessories

Call or visit your local retailer/dealer for genuine Canon video accessories. You can also obtain genuine accessories for your Canon camcorder by calling: 1-800-828-4040, Canon U.S.A. Information Center.

Use of genuine Canon accessories is recommended.

This product is designed to perform optimally when used with genuine Canon accessories. Canon shall not be liable for any damage to this product and/or accidents such as fire, etc., caused by the malfunction of non-genuine Canon accessories (e.g., a leakage and/or explosion of a battery pack). Please note that this warranty does not apply to repairs arising out of the malfunction of non-genuine Canon accessories, although you may request such repairs on a chargeable basis.

Battery Packs

When you need extra battery packs, select from the following: NB-2L, NB-2LH, BP-2L12, BP-2L14.

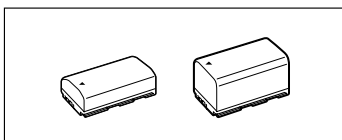

CB-2LT Battery Charger

Use the battery charger for charging the battery packs. It plugs directly into a power outlet without a cable.

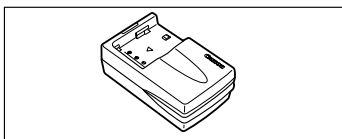

Battery Pack	Charging Time
BP-2L14	170 min.
NB-2LH	90 min.
NB-2L	80 min.
BP-2L12	150 min.

* Charging time varies according to the charging condition.

CBC-NB2 Car Battery Charger

Use the car battery charger to charge battery packs on the move. The car battery cable plugs into your car's cigarette lighter and runs off a 12-24 V DC negative ground battery.

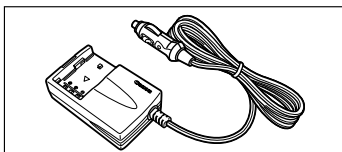

TL-H34 Tele-converter

This Tele-converter lens increases the focal length of the camcorder lens by a factor of 1.5.

- The image stabilizer is not as effective when the Tele-converter is attached.
- The minimum focusing distance with the TL-H34 is 8.2 ft. (2.5 m); 0.98 in. (2.5 cm) at maximum wide angle.
- When the Tele-converter is attached, a shadow may appear in the picture when you record with video light (ELURA70/ELURA65: or with assist lamp or flash).

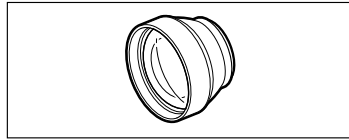

E

WD-H34 Wide-converter

This lens decreases focal length by a factor of 0.7, giving you a wide perspective for indoor shots or panoramic views.

- When the Wide-converter is attached, a shadow may appear in the picture when you record with video light (ELURA70/ELURA65: or with assist lamp or flash).

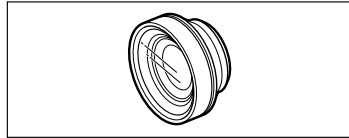

FS-34U Filter Set

Neutral density and MC protector filters help you to control difficult lighting conditions.

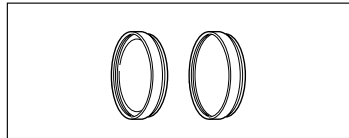

VL-10Li Battery Video Light

This compact yet powerful video light can be used for both indoor and outdoor shooting. It attaches to the camcorder's accessory shoe and is powered by BP-900 series battery packs.

- Approximate usage time: BP-915: 60 min., BP-930: 120 min., BP-945: 170 min.
- BP-900 series battery packs are charged with the CA-920 Compact Power Adapter or CH-910 Dual Battery Charger/Holder.

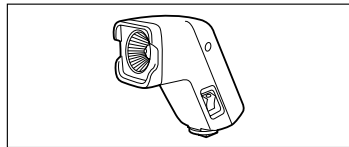

WS-20 Wrist Strap

Use this for extra additional protection for active shooting.

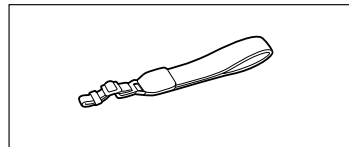

Additional
Information

SC-1000/SC-2000 Soft Carrying Case

A handy camcorder bag with padded compartments and plenty of space for accessories.

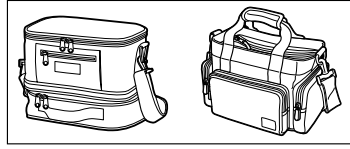

SC-A50 Soft Carrying Case

This lightweight bag keeps the camcorder within easy reach without weighing you down or getting in the way.



ELURA 70/ELURA 65

VFL-1 Video Flash Light

This video flash light allows you to record still images and movies even at night or in dark places. It attaches to the camcorder's advanced accessory shoe for cable-free operation.

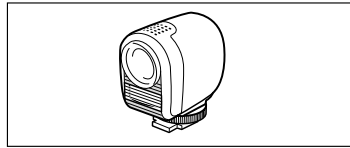

VL-3 Video Light

This video light enables you to record brightly in color even in dark places. It attaches to the camcorder's advanced accessory shoe for cable-free operation.

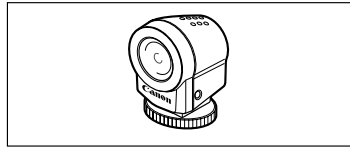

DM-50 Directional Stereo Microphone

This highly sensitive, super-directional microphone attaches to the camcorder's advanced accessory shoe. It can be used as directional microphone (monaural) or stereo microphone.

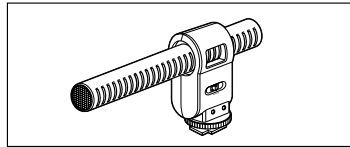

This mark identifies genuine Canon video accessories. When you use Canon video equipment, we recommend Canon-brand accessories or products bearing the same mark.



Specifications

ELURA70/ELURA65/ELURA60

E

System

Video Recording System	2 rotary heads, helical scanning DV system (consumer digital VCR SD system), digital component recording
Audio Recording System	PCM digital sound: 16 bit (48 kHz/2 ch); 12 bit (32 kHz/4 ch)
Television System	EIA standard (525 lines, 60 fields) NTSC color signal
Image Sensor	1/4.5-inch CCD, approx. 1,330,000 pixels Effective pixels: tape approx. 690,000 pixels card approx. 1,230,000 pixels
Tape Format	Videocassettes bearing the "MiniDV" mark.
Tape Speed	SP: 0.74 ips (18.81 mm/s), LP: 0.49 ips (12.56 mm/s)
Maximum Recording Time (80 min. cassette)	SP: 80 min., LP: 120 min.
Fast Forward/Rewind Time	Approx. 2 min. 20 sec. (with a 60 min. cassette)
LCD Screen	2.5-inch. TFT color, approx. 123,000 pixels
Viewfinder	0.33-inch. TFT color, approx. 113,000 pixels
Microphone	Stereo electret condenser microphone
Lens	ELURA70: f=3.5-63 mm, f/1.8-3.4, 18x power zoom ELURA65: f=3.5-56 mm, f/1.8-3.3, 16x power zoom ELURA60: f=3.5-49 mm, f/1.8-3.1, 14x power zoom
Lens Configuration	10 elements in 8 groups
Filter Diameter	34 mm
AF system	TTL autofocus, manual focusing possible
Minimum Focusing Distance	3.3 ft. (1 m); 0.39 in. (1 cm) on maximum wide angle
White Balance	Auto white balance, pre-set white balance (indoor, outdoor) or custom white balance
Minimum Illumination	1.8 lx (using the Night mode)
Recommended Illumination	More than 100 lx
Image Stabilization	Electronic

Memory Card

Recording media	SD Memory Card, MultiMediaCard
Number of Recording Pixels	Still image: 1280 × 960, 640 × 480 pixels Movie: 320 × 240, 160 × 120 pixels, 15 frames/sec.
File Format	Design rule for Camera File system (DCF), Exif 2.2* compliant, DPOF compliant
*This camcorder supports Exif 2.2 (also called "Exif Print"). Exif Print is a standard for enhancing the communication between camcorders and printers. By connecting to an Exif Print-compliant printer, the camcorder's image data at the time of shooting is used and optimized, yielding extremely high quality prints.	
Image Recording Format	Still image: JPEG (compression: Super Fine, Fine, Normal) Movie: AVI (image data: Motion JPEG; audio data: WAVE (monaural))

Additional
Information

Input/Output Terminals

AV Terminal	ø3.5 mm minijack Video: 1 Vp-p/75 ohms unbalanced Audio output: -10 dBV (47 kohm load)/3 kohms or less Audio input: -10 dBV/40 kohms or more
DV Terminal	Special 4-pin connector (IEEE 1394 compliant)
MIC Terminal (ELURA70/ELURA65)	ø3.5 mm stereo mini-jack -57 dBV (with 600 ohm mic)/5 kohms or more
Headphone Terminal	ø3.5 mm stereo mini-jack
USB Terminal	mini-B
S-video Terminal	1 Vp-p/75 ohms (Y signal), 0.286 Vp-p/75 ohms (C signal)

Power/Others

Power supply (rated)	7.4 V DC
Power consumption (AF on)	2.6W (using viewfinder), 3.3W (using LCD screen)
Operating temperature	32 – 104 °F (0 – 40 °C)
Dimensions (W × H × D)	2.9 × 3.1 × 5.1 in. (74 × 78 × 130 mm) excluding protrusions
Weight (camcorder body only)	1.1 lb. (500 g)

CA-570 Compact Power Adapter

Power supply	100 – 240 V AC, 50/60 Hz
Power consumption	17W
Rated output	8.4 V DC, 1.5 A
Operating temperature	32 – 104 °F (0 – 40 °C)
Dimensions	2.1 × 3.5 × 1.1 in. (52 × 90 × 29 mm)
Weight	4.8 oz. (135 g)

BP-2L14/NB-2LH Battery Pack

Battery type	Rechargeable Lithium Ion Battery
Rated voltage	7.4 V DC
Operating temperature	32 – 104 °F (0 – 40 °C)
Battery capacity	BP-2L14: 1450 mAh; NB-2LH: 720 mAh
Dimensions	BP-2L14: 1.3 × 1.2 × 1.8 in. (33.3 × 31 × 45.2 mm) NB-2LH: 1.3 × 0.64 × 1.8 in. (33.3 × 16.2 × 45.2 mm)
Weight	BP-2L14: 2.9 oz. (82 g); NB-2LH: 1.5 oz. (43 g)

SDC-8M SD Memory Card

Capacity	8 MB
Interface	SD Memory Card standard
Operating temperature	32 – 104 °F (0 – 40 °C)
Dimensions	1.3 × 0.94 × 0.08 in. (32 × 24 × 2.1 mm)
Weight	0.07 oz. (2 g)

Weight and dimensions are approximate. Errors and omissions excepted. Subject to change without notice.

Item Codes

Provided Accessories

Lens Cap	D52-0260-000
CA-570 Compact Power Adapter	8468A002AA
BP-2L14 Battery Pack	9582A002AA
NB-2LH Battery Pack	9612A001AA
STV-250N Stereo Video Cable	3067A002AA (D82-0590-201)
SS-900 Shoulder Strap	D81-1470-000
WL-D83 Wireless Controller	D83-0682-000
IFC-300PCU USB Cable	6906A001AA
WA-34 Wide Attachment	D55-0240-000

E

Optional Accessories

BP-2L12	7871A002AA
NB-2L	7302A001AA
CB-2LT Battery Charger	7303A001AA
CBC-NB2 Car Battery Charger	7873A002AA
S-150 S-Video Cable	3062A002AA (D82-0330-202)
TL-H34 Tele-converter	9583A001AA
WD-H34 Wide-converter	9584A001AA
FS-34U Filter Set	8081A001AA
VFL-1 Video Flash Light	8834A001AA
VL-3 Video Light	3175A002AA (D86-0121-201)
DM-50 Directional Stereo Microphone	3176A002AA (D84-0120-201)
WS-20 Wrist Strap	3118A002AA (D81-0190-202)
SC-2000 Soft Carrying Case	9389A001AA
SC-1000 Soft Carrying Case	3083A002AA (D81-1200-201)
SC-A50 Soft Carrying Case	D81-1302-201
VL-10Li Battery Video Light	3140A002AA (D86-0081-201)
JR 7.2V 10WF Halogen Bulb	3141A002AA (D86-0090-201)
DVM-CL DV Cleaning Cassette	3134A002AA (D36-0032-201)

Index

12bit audio 90
16:9 widescreen 78
6-second auto date 71

A

Abroad, using the camcorder . . . 147
Accessories. 8, 152
Advanced accessory shoe 80
AF-assist lamp 81
Analog line-in 84
Analog-digital converter. 86
Assist lamp 48
Audio dubbing 88
Audio mode 60
Auto 45
Auto Exposure Bracketing 105
Autofocus 52
AV → DV 86
AV/headphones terminal 34, 35

B

Backup battery 17
Battery charger 152
Battery pack 13
Beep 78
Brightness 26

C

Card jump 110
Card mix 113
Computer 91, 130
Condensation 144
Connections - TV 35
Connections - VCR. 35
Continuous shooting. 104
Copyright signals. 85

D

Data code 70
Date and time. 21
Date format 76
Date search 74
Demo mode 79
Digital effects 62
Digital zoom 30

Direct print function 119
Direct transfer. 131
Drive mode 104
DV dubbing. 85
DV terminal. 82, 91

E

Easy recording. 45
Effects 64
End search. 72
Erasing images 112
Exposure 51

F

Faders 62
Fast forward 32
File numbers 95
Focusing 52
Focusing point. 103
Focus-Priority. 103
Formatting 117

G

Grip belt 18

H

Headphones 34, 61

I

Image quality 93
Image stabilizer. 79
Index screen 109
Infinity focus 53

L

Language 76
LCD mirror mode 25
LCD screen. 24
Lens cap 18
Low light mode. 45
LP mode 59

M

Maintenance 142
Manual focus 52

Memory card 92
 Menus 38-44
 Microphone 61, 88
 MIC terminal 61, 88
 Movie size 94
 MultiMediaCard 92
 Multi-image screen 64
 My Camera settings 75

N

ND filter 97
 NETWORK mode 135
 Night mode 48
 Night+ mode 48

O

Operating Mode 5
 Output channel 37

P

Playback - Memory card 108
 Playback - Tape 32
 Playback pause 33
 Portrait mode 45
 Power adapter 13
 Print order 128
 Program AE 45
 Protect 111

R

Record review 28
 Record search 28
 Recording movies (memory card) 101
 Recording movies (tape) 24
 Recording programs 45
 Recording still images
 (memory card) 96
 Remote sensor 77
 Review 100
 Rewind 32

S

S1 video terminal 36
 Sample images 116
 Sand & Snow mode 45
 Screen displays 136
 SD Memory Card 92

Self-timer 58
 Shoulder strap 19
 Shutter speed 56
 Skin detail 50
 Slide show 109
 SP mode 59
 Speaker 34
 Sports mode 45
 Spotlight mode 45
 Still image quality 93
 Still image size 93
 Stitch Assist mode 106
 Super Night mode 48

T

Tape protection 146
 Time code 27
 Time zone 21
 Transfer order 134
 Tripod 31
 Troubleshooting 148
 TV Screen 35, 136

U

USB terminal 119, 130

V

Video heads 143
 Video light 153, 154
 Videocassettes 16
 Viewfinder 18

W

White balance 54
 Wide attachment 19
 Widescreen 78
 Wind screen 60
 Wireless controller 20

Z

Zero set memory 73
 Zooming 29

U.S.A.

E

CANON CONSUMER DIGITAL VIDEO EQUIPMENT LIMITED WARRANTY FOR THE UNITED STATES

The warranty set forward below is given by Canon U.S.A., Inc. with respect to equipment purchased in the United States. The limited warranty is only effective upon presentation of your Bill of Sale or other proof of purchase. Canon consumer digital video equipment is warranted under normal, non-commercial, personal use, against defective materials or workmanship as follows:

Parts: Defective parts will be exchanged for new parts or comparable rebuilt parts for a period of ONE YEAR from the date of original purchase, except for a defective Video Head, which will be exchanged for a period of three months from the date of purchase.

Labor: For a period of ONE YEAR from the date of original purchase, labor will be provided free of charge by our factory service centers or designated service facilities located in the United States.

When returning equipment under this warranty, you must pre-pay the shipping charges, and you must enclose the Bill of Sale or other proof of purchase with a complete explanation of the problem. During your ONE-YEAR warranty period, repairs will be made and the equipment return-shipped to you free of charge. After your warranty period is over, you will be given an estimate of the cost of repair and an opportunity to approve or disapprove of the repair expense before it is incurred. If you approve, repairs will be made and the equipment return-shipped to you. (shipping charges apply). If you disapprove, we will return-ship the equipment at no charge to you.

Non-Canon brand peripheral equipment and software which may be distributed with Canon DV camcorders are sold "AS IS" without warranty of any kind by CUSA, including any implied warranty regarding merchantability or fitness for a particular purpose. The sole warranty with respect to such non-Canon brand items is given by the manufacturer or producer thereof.

CUSA shall have no responsibility under this limited warranty for use of Canon DV Camcorders in conjunction with incompatible peripheral equipment and incompatible software.

In order to obtain warranty service, contact the authorized Canon retail dealer from whom you purchased the DV Camcorder or call the CANON INFORMATION CENTER AT 1-800-828-4040. You will be directed to the nearest service facility for your product.

This Limited Warranty covers all defects encountered in normal use of the equipment and does not apply in the following cases:

- A) Loss or damage to the equipment due to abuse, mishandling, accident, improper maintenance, or failure to follow operating instructions;
- B) If the equipment is defective as a result of leaking batteries, sand, dirt or water damage;
- C) If defects or damages are caused by the use of unauthorized parts or by service other than our authorized agent;
- D) If the equipment is used for commercial or industrial use.

This Limited Warranty does not cover cabinet (exterior finish), video cassette tape, head cleanings, nor does it apply to equipment purchased outside the United States. This warranty does not cover units sold to rental firms, military operations, hotels, schools, hospitals or for other commercial, industrial, or institutional applications. These uses are covered only by such specific warranty as Canon may issue with such sales.

This Limited Warranty does not apply to accessories or consumables for the DV Camcorder, which are sold "AS IS", without warranty of any kind by CUSA.

Please retain this warranty card and your Bill of Sale as a permanent record of your purchase. This card is most important in order to be sure you are contacted right away should there be a safety inspection, modification or product recall under applicable laws or regulations.

NO IMPLIED WARRANTY, INCLUDING MERCHANTABILITY AND FITNESS FOR A PARTICULAR PURPOSE APPLIES TO THIS EQUIPMENT AFTER THE APPLICABLE PERIOD OF EXPRESS WARRANTY OR GUARANTY, EXCEPT AS MENTIONED ABOVE, GIVEN BY ANY PERSON, FIRM OR CORPORATION WITH RESPECT TO THIS EQUIPMENT SHALL BIND THE UNDERSIGNED. (SOME STATES DO NOT ALLOW LIMITATIONS ON HOW LONG AN IMPLIED WARRANTY LASTS, SO THE ABOVE LIMITATION OR EXCLUSION MAY NOT APPLY TO YOU). CUSA SHALL NOT BE LIABLE FOR LOSS OF REVENUES OR PROFITS, EXPENSE FOR SUBSTITUTE EQUIPMENT OR SERVICE, STORAGE CHARGES, LOSS OF DATA, OR ANY OTHER SPECIAL, INCIDENTAL OR CONSEQUENTIAL DAMAGES CAUSED BY THE USE, MISUSE OR INABILITY TO USE THE DV CAMCORDER, REGARDLESS OF THE LEGAL THEORY ON WHICH THE CLAIM IS BASED, AND EVEN IF CUSA HAS BEEN ADVISED OF THE POSSIBILITY OF SUCH DAMAGES. NOR SHALL RECOVERY OF ANY KIND AGAINST CUSA BE GREATER THAN THE PURCHASE PRICE OF THE DV CAMCORDER SOLD BY CUSA AND CAUSING THE ALLEGED DAMAGE. WITHOUT LIMITING THE FOREGOING, YOU ASSUME ALL RISK AND LIABILITY FOR LOSS, DAMAGE OR INJURY TO YOU AND YOUR PROPERTY AND TO OTHERS AND THEIR PROPERTY ARISING OUT OF USE, MISUSE OR INABILITY TO USE THE DV CAMCORDER NOT CAUSED DIRECTLY BY THE NEGLIGENCE OF CUSA. (SOME STATES DO NOT ALLOW THE EXCLUSION OR LIMITATION OF INCIDENTAL OR CONSEQUENTIAL DAMAGES, SO THE ABOVE LIMITATION MAY NOT APPLY TO YOU).THIS WARRANTY SHALL NOT EXTEND TO ANYONE OTHER THAN THE ORIGINAL PURCHASER OF THIS EQUIPMENT OR THE PERSON FOR WHOM IT WAS PURCHASED AS A GIFT.

This warranty gives you specific legal rights, and you may also have other rights which vary from state to state. CANON U.S.A., INC.

CANADA

CANON CONSUMER DIGITAL VIDEO EQUIPMENT LIMITED WARRANTY

E

The limited warranty set forth below is given by Canon Canada Inc. ("Canon Canada") with respect to Canon digital video equipment purchased in Canada. This limited warranty is only effective upon presentation of a bill of sale or other proof of purchase for this Canon digital video equipment to a Canon Service Facility when repairs are required.

Canon consumer video digital equipment is warranted under normal, non-commercial, personal use, against defective materials or workmanship as follows:

Parts: Defective parts will be exchanged for new parts or, at Canon Canada's option, comparable rebuilt parts for a period of one year from the date of original purchase, except Video Heads which will be exchanged for a period of 3 months from the date of purchase.

Labour: For a period of one year from the date of original purchase, labour will be provided free of charge by our Canon Service Facilities in Canada.

This limited warranty covers all defects except where:

- (a) The loss or damage to the product results from:
 - i) accident, natural disaster, mishandling, abuse, neglect, unauthorized product modification or failure to follow instructions contained in the instruction manual;
 - ii) the use of accessories, attachments, products, supplies, parts or devices with this Canon product that do not conform to Canon specifications or that cause abnormally frequent service problems;
 - iii) repairs or services performed by any party other than a Canon Service Facility;
 - iv) defective batteries or any exposure to water, sand or dirt;
 - v) shipping (claim must be presented to the shipper);
 - (b) Any serial number on the video equipment is altered or removed.
 - (c) The digital video equipment is used for commercial, professional or industrial purposes.
- This limited warranty does not cover the cabinet (exterior finish) of the digital video equipment, video cassette tapes, head cleanings, nor does it apply to digital video equipment purchased outside Canada.

TO OBTAIN WARRANTY SERVICE

Ship your Canon digital video equipment in its original carton, box or equivalent, properly packed, fully insured with shipping charges prepaid, together with a copy of your bill of sale or other proof of purchase and a description of the problem to any of the Canon Service Facilities in Canada.

LIMITATIONS

Except as otherwise required by applicable legislation, this warranty is in lieu of all other warranties, conditions, guarantees or representations, express or implied, statutory or otherwise, relative to this Canon product, including implied warranties or conditions of merchantability or fitness for a particular purpose.

Canon Canada assumes no liability for special, consequential or incidental damages or loss that may arise, whether on account of negligence or otherwise, from the use, misuse or inability to use this Canon product (including loss of profit, revenue, video tapes or enjoyment) or from failure to conform to any express or implied warranties, conditions, guarantees or representations. Any recovery under this limited warranty shall not exceed the purchase price of the product. Canon Canada does not assume or authorize any other person to assume for Canon Canada any other liability with respect to this Canon product.

This warranty does not extend to any person other than the original purchaser of this Canon product or the person for whom it was purchased as a gift and states your exclusive remedy.

NOTICE TO CONSUMER

If you plan to take important videos or if the product has not been used for some time, please check all functions with the instruction book before using it.

Canon

CANON INC.

U.S.A. ————— **CANON U.S.A., INC. NEW JERSEY OFFICE**
100 Jamesburg Road, Jamesburg, NJ 08831 USA

CANON U.S.A., INC. CHICAGO OFFICE
100 Park Blvd., Itasca, IL 60143 USA

CANON U.S.A., INC. LOS ANGELES OFFICE
15955 Alton Parkway, Irvine, CA 92618 USA

CANON U.S.A., INC. HONOLULU OFFICE
210 Ward Avenue, Suite 200, Honolulu, HI 96814 USA

- **If you have any questions, call the Canon U.S.A. Information Center toll-free at 1-800-828-4040 (U.S.A. only).**

CANADA ————— **CANON CANADA INC. NATIONAL HEADQUARTERS**
6390 Dixie Road, Mississauga, Ontario L5T 1P7

CANON CANADA INC. CALGARY
2828, 16th Street, N.E. Calgary, Alberta T2E 7K7

CANON CANADA INC. MONTREAL
5990 Côte de Liesse, Quebec H4T 1V7

- **If you have any questions, call the Canon Canada Information Center toll-free at 1-800-828-4040. (Canada only)**
- **Si vous avez des questions, veuillez téléphoner sans frais au Canada 1-800-828-4040. (Canada seulement)**

MEXICO ————— **CANON MEXICANA, S. DE R.L. DE C.V.**
Periferico Sur No. 4124 Col. Ex-Rancho de Anzaldo C.P. 01900
México, D.F., México

CENTRAL Y SURAMÉRICA ————— **CANON LATIN AMERICA, INC.**
703 Waterford Way Suite 400 Miami, FL 33126 USA

ASIA ————— **CANON HONGKONG COMPANY LTD.**
19/F, The Metropolis Tower, 10 Metropolis Drive, Hunghom, Kowloon, Hong Kong



Printed on 100% reused paper.
Document réalisé avec du papier recyclé à 100%.
El papel aquí utilizado es 100% reciclado.